

## INTRODUCCIÓN AL PROGRAMA DE PRODUCTOS CdA - COMPONENTES DEL AIRE S.L. :

Distribución nacional de los productos de nuestras marcas representadas AIRTX International - USA y CDC PNEUMATICS - COREA. El resto de productos que completan la gama corresponden a un compendio de fabricados con una excelente relación calidad-precio. Pueden solicitar los certificados ISO e información técnica de cada producto, también pueden visitar nuestra web: [www.componentesdelaire.com](http://www.componentesdelaire.com) ; [www.cda.cat](http://www.cda.cat) o contacten a los e-mail: [consultas@componentesdelaire.com](mailto:consultas@componentesdelaire.com) ; [comercial@cda.cat](mailto:comercial@cda.cat)



### GAMA PRODUCTOS AIRTX INTERNATIONAL:

Tecnología punta líder en soplado, boquillas, barreras, amplificadores y aros de soplado, refrigeración por Tubo Vortex, Antiestática, Aspiración de sólidos y fluidos por vacío. Todo el programa AIRTX está en stock. Pueden solicitar el catálogo general (En Inglés) e información técnica adicional.

### GAMA PRODUCTOS CDC PNEUMATICS:

Racores Instantáneos termoplástico para aire comprimido de excelente calidad, con pinza interna inoxidable y collarín de estanqueidad. Disponibles en stock para tubo en métrica, rosca cónica y cilíndrica. También en rosca NPT y Tubo Gas. Todo el programa de CDC está en stock. Pueden solicitar el catálogo general e información técnica. ISO9001 RoHS compliant

### GAMA PRODUCTOS FLUIDFIT:

Racores Instantáneos para fluidos, agua, bebidas, etc. Fabricados en plástico POM compatible NSF uso alimentario con pinza interna inoxidable y junta EPDM. Disponibles en stock para tubo en métrica, rosca cónica, cilíndrica. También en rosca NPT y Tubo Gas.

## ÍNDICE:

- Páginas 7 a la 10..:** Refrigeración AIRTX: Tecnología, usos y variantes del Tubo Vortex
- Páginas 11 a la 17:** Soplado AIRTX: Boquillas, Pistolas, Barreras, Amplificadores, Aros aire
- Páginas 18 a la 19:** Antiestática AIRTX: Barreras, Boquillas y Pistolas de Ionización
- Páginas 20 a la 23:** Aspiración AIRTX: Conveyvac, Speedvac, Smartvac, Drum Devil.
- Páginas 24 a la 42:** Racores Instantáneos CDC: Racores tubo y rosca
- Páginas 42 a la 44:** Racores Instantáneos Compactos CDC
- Páginas 45 a la 49:** Reguladores de Caudal CDC
- Páginas 50 a la 53:** Válvulas cierre c/descarga, Válvulas de Bloqueo, Antirretorno CDC
- Página 54.....:** Válvula Pilotada reguladora de Caudal.
- Páginas 55.....:** Racores rápidos POM CDC
- Páginas 56 a la 62:** Racores FLUIDFIT p/agua y fluidos.
- Páginas 63 a la 65:** Racores Instantáneos Inox. y latón cromado
- Página 66 a la 67..:** Racores Rápidos tuerca moleteada y Tuerca-Bicono latón crm. e Inox.
- Páginas 68 a la 74:** Racores Roscados latón e Inox, complementos Metálicos
- Página 75.....:** Distribuidores de Aluminio
- Página 76.....:** Silenciadores
- Página 77.....:** Válvulas cierre; Antirretorno; Escape; Regulador; Pistolas y Cortatubos
- Página 78.....:** Enchufe Rápido Universal, Enchufe de seguridad y Adaptadores
- Página 79.....:** Filtraje F-R-L y Manómetros
- Página 80.....:** Tubo Poliuretano CDC, Espirales PUR
- Página 81.....:** Tubo PA, PE, PTFE, etc... Tubos y Mangueras Técnicas
- Página 82.....:** OEL - Módulos Refrigeración aceite/aire/agua CDC
- Página 83.....:** Expositores, Maletín Airtx
- Página 84.....:** Racores PVDF - FEP
- Páginas 85 a la 91:** Datos adicionales. Tablas de compatibilidades químicas racores y tubo



**AIRE:** Páginas de la 7 a la 54 y de la 66 a la 82



**FLUIDOS:** Páginas de la 55 a la 77 y de la 80 a la 84



ISO-9001



## NOMENCLATURA DE CÓDIGOS PARA TODOS LOS RACORES:

Los primeras letras hacen referencia a la familia / figura. Los dos o cuatro siguientes cifras corresponden a los diámetros exteriores / interiores del tubo en milímetros /gas. - Las últimas dos cifras corresponden a la rosca cónica (si hay) y se añade una "G" cuando es rosca cilíndrica:

M3 - M3	03 - 3/8"	08 - 1-1/2"
M5 - M5	04 - 1/2"	09 - 2"
M6 - M6	05 - 3/4"	10 - 2-1/2"
01 - 1/8"	06 - 1"	11 - 3"
02 - 1/4"	07 - 1-1/4"	12 - 4"

**ÍNDICE-GUÍA DE PRODUCTOS: Referencias generales de productos por imagen y página.**



200_ Pag. 7	600_ Pag. 8	700_ Pag. 9	40/48005 Pag.11	40/48107 Pag. 11	40/48002 Pag.11	40/48009 Pag.11
40/48109 Pag.11	40/48008 Pag.11	48002 Pag.11	48010 Pag. 12	48006 Pag.12	48004 Pag.12	48807/8 Pag. 13
48012/3/4 Pag. 13	48212/3/4 Pag.13	400001 Pag. 13	400001-A Pag. 13	38003 Pag. 13	38006-4 Pag.13	ME8220 Pag.13
860_ Pag. 14	80/850_ Pag.15	80/82_ Pag.15	38038 Pag. 15	38044 Pag. 15	30/38050 Pag.16	30/38054 Pag.16
10/150_ Pag. 17	10/1610_ Pag. 17	550_ Pag. 18	50000/2-1 Pag.18	50003 Pag. 18	50006 Pag. 18	ME50005 Pag. 18
90/98_ Pag. 20	9040_ Pag. 21	95308 Pag. 21	90755 Pag. 22	99755 Pag. 22	90600 Pag. 23	90650 Pag. 23



PC Pag.25	PC-G Pag.25	PCF Pag.25	PCF-G Pag.26	POC Pag.26	PMP Pag.26	PMM Pag.26
PMF-G Pag.26	PL Pag.27	PL-G Pag.27	PLF-G Pag.27	PL45 Pag.28	PLL Pag.28	PLL-G Pag.28
PLL-P Pag.29	PLL-P-G Pag.29	PT Pag.29	PT-G Pag.30	PTF-G Pag.30	PST Pag.30	PST-G Pag.31



PWT Pag.31



PWT-G Pag.31



PXT Pag.32



PKD Pag.32



PKD-G Pag.32



CAS Pag.32



PH Pag.32



PH-G Pag.33



PHF Pag.33



PHF-G Pag.33



PHL(2) Pag.33



PHL-G(2) Pag.34



PHL(3) Pag.34



PHL-G(3) Pag.34



PHT(1) Pag.35



PHT-G(1) Pag.35



PHT(2) Pag.35



PHT-G(2) Pag.35



PHT(3) Pag.36



PHT-G(3) Pag.36



PA Pag.36



PA-G Pag.36



PAF Pag.37



PAF-G Pag.37



PAT(2) Pag.37



PAT-G(2) Pag.37



PAT(3) Pag.37



PAT-G Pag.38



PUC Pag.38



PUL Pag.38



PUT Pag.38



PY Pag.38



PW Pag.39



PG Pag.39



PTG/PJT Pag.39



PLJ Pag.39



PGJ Pag.39



PYJ Pag.40



PWJ Pag.40



PIJ Pag.40



PSJ Pag.40



PTJ Pag.40



PIG Pag.41



PP Pag.41



PPF Pag.41



PZA Pag.41



PKG Pag.41



PXG Pag.41



PXJ Pag.42



PKJ Pag.42



PC-C Pag.42



PCF-C Pag.42



POC-C Pag.42



PMM-C Pag.43



PL-C Pag.43



PLL-C Pag.43



PTC-C Pag.43



PST-C Pag.43



PUC-C Pag.43



PUL-C Pag.44



PUT-C Pag.44



PG-C Pag.44



PY-C Pag.44



PW-C Pag.44



PGJ-C Pag.44



NSC Pag.45



NSC-G Pag.45



NSC(D) Pag.45



NSCF Pag.46



NSC(DC) Pag.46



NSC-G(DC) Pag.46



NSS Pag.47



NSS(D) Pag.47



NSS(DC) Pag.47



NSF Pag.47



NSFB Pag.47



NSFF Pag.48



ESC Pag.48



NSFP Pag.48



NSFP Pag.49



NSFP-G Pag.49



NSSP-G Pag.49



HVC Pag.50



HVC-G Pag.50



HVF Pag.50



HVF-G Pag.50



HVU Pag.51



HVM Pag.51



HVM-G Pag.51



HSV Pag.51



SPC Pag.51



SPC-G Pag.52



SPL Pag.52



SPL-G Pag.52



SPU Pag.52



CVPC Pag.53



CVPC-G Pag.53



CVFF Pag.53



CVPF Pag.53



CVPF-G Pag.53



CVPU Pag.53



PVSC Pag.54



PVSC-G Pag.54



PVSF Pag.54



CK Pag.55



GCK Pag.55



FCK Pag.55



HPC Pag.56



HPC-G Pag.56



HCF Pag.56



HCJ Pag.57



HCJ-G Pag.57



HUC Pag.57



HUL Pag.57



HUT Pag.57



HUY Pag.57



HPL Pag.58



HLJ Pag.58



HGJ Pag.58



HMM Pag.58



HPF Pag.58



HCVU Pag.58



HCP Pag.58



HBVU Pag.58



HPC Pag.59



HPF Pag.59



HCJ Pag.59



HPL Pag.60



HUC Pag.60



HUL Pag.60



HUT Pag.60



HUY Pag.61



HLJ Pag.61



HGJ Pag.61



HMM Pag.61



HPF Pag.62



HPP Pag.62



HCVU Pag.62



HCP Pag.62



HBVU Pag.62



HSLB Pag.62



HSLB Pag.62



INOXMC Pag.63



INOXML Pag.63



INOXMUC Pag.63



INOXMUL Pag.63



INOXMUT Pag.63



INOXMT Pag.63



INOXMM Pag.63



INOXMLG Pag.63



MC Pag.64



MC-G Pag.64



ML Pag.64



						
INOXVHM Pag.74	INOXVBHH Pag.74	INOXVAT Pag.74	INOXRAL Pag.74	RA Pag.75	RAL Pag.75	RAT Pag.75
						
BSLM Pag.76	BSL Pag.76	INOXBSLM Pag.76	BESL Pag.76	BSLMP Pag.76	BSLP Pag.76	ST Pag.76
						
VHH Pag.76	VHM Pag.76	VHH-C Pag.77	VHM-C Pag.77	VMM-C Pag.77	VMAN-C Pag.77	VC Pag.77
						
VBHH Pag.77	VAT Pag.77	VPA Pag.77	VES Pag.77	VRE Pag.77	CB Pag.77	CA Pag.77
						
ETC-20 Pag.77	C0001 Pag.77	AIRTINBOK Pag.77	C0002/3 Pag.77	TEFLON Pag.77	TEFLON50 Pag.77	UNIM Pag.78
						
UNIH Pag.78	UNIE Pag.78	UM Pag.78	UH Pag.78	UE Pag.78	URU Pag.78	UNIS Pag.78
						
FR Pag.79	FFI Pag.79	FFR Pag.79	FFRL Pag.79	FLU Pag.79	MR Pag.79	PEL Pag.79
						
SPIR Pag.80	MPF/MPG Pag.80	TUBO PUR Pag.80	TUBO PA Pag.81	PTFE Pag.81	FEP Pag.81	PVDF Pag.81
						
PE-BD Pag.81	RZ Pag.81	AMG Pag.81	CMG Pag.81	DKB Pag.81	MATX Pag.81	MANT Pag.81
						
OEL HOSE Pag.82	OEL RN Pag.82	OEL FN Pag.82	OEL PT Pag.82	OEL Y Pag.82	OEL DS Pag.82	OEL N16/20 Pag.82
						
OEL VALVE Pag.82	OEL TV Pag.82	OEL300-600 Pag.82	EXP Pag.83	MALETIN Pag.83	MEDICIÓN Pag.83	PVDF Pag.84



## REFRIGERACIÓN AIRTX: TUBO VORTEX DE ACERO INOXIDABLE

Aire frío Instantáneo. Hasta -40°C. Usos industriales: puntos de enfriamiento o calentamiento (110°C).

¿Qué es un Tubo Vortex? Respuesta de refrigeración instantánea, donde y cuando se necesite, bajo coste, sin mantenimiento, sin riesgo de explosión, sin electricidad y sin partes adicionales... Soluciona una gran variedad de problemas industriales. Usando una fuente ordinaria de aire comprimido como fuente de energía, los tubos vortex crean una corriente de aire frío y otra de caliente. Los tubos vortex pueden producir: Temperaturas de -40°C a +110°C · Flujos hasta 990 lts/min. · Refrigeración hasta 630 Kcal/h. Las temperaturas, los caudales y la refrigeración son ajustables en un amplio ratio usando la válvula de control, intercambiando los generadores o regulando la presión.

### ¿POR QUÉ TUBOS VORTEX AIRTX?

Primero por ser resistentes a la corrosión, por estar fabricados en Acero Inoxidable de calidad Aisi 314. La resistencia al desgaste del acero inoxidable, así como su resistencia a la corrosión y a la oxidación aseguran años de uso continuado sin apenas mantenimiento.

Segundo por su aspecto y funcionalidad, no integran partes en aluminio, ni cromados, es una maquinaria sutilmente precisa y bien ensamblada.

### USOS Y VENTAJAS

Refrigerar procesos de manufacturación: Máquinas de plásticos o metales, madera, soldadura, colas, sellado por calor, moldes, cuadros eléctricos y muchos otros. Fácil montaje, económico. Sólo dos medidas, una de ellas con ocho posibilidades. Sin mantenimiento. Sin uso de gases ni CFC's - Ecológico. Sin electricidad ni riesgo de explosión ni interferencias RF/EMI.

Aire acondicionado para cajas electrónicas: CNC, PC's, PLC's, controles de motor, CICLO DE TEMPERATURA" de componentes electrónicos, instrumentos...

Aire caliente sin riesgo de explosión para plásticos blandos, colas hot-melt, envase. En laboratorio enfriar y deshumidificar partes con gases. Enfriar cámaras.

Uso alimentario, una posible primera fase de enfriado del producto después del horneado y previo a la cámara frigorífica.

### ¿CÓMO FUNCIONA UN TUBO VORTEX?

El aire comprimido, normalmente a 80-100 psi (5.5-6.9 bar), se expulsa tangencialmente a través de un generador en el compartimento de la cámara de giro del Vortex. Esta corriente alcanza hasta 1.000.000 r.p.m y el aire gira hacia el extremo caliente donde se escapa a través de la válvula de control. El aire restante girando inmóvil se fuerza a través del centro del Vortex hacia atrás. La corriente interna emite energía cinética en forma de calor a la corriente externa y sale del tubo del Vortex como aire frío. La corriente externa sale del extremo opuesto como aire caliente.

La circulación de aire frío y la temperatura son controladas fácilmente ajustando la válvula ranurada en el enchufe de aire caliente. Abrir la válvula reduce la circulación y la temperatura del aire frío. El cierre de la válvula aumenta la circulación y la temperatura del aire frío.

El porcentaje de aire dirigido al enchufe frío del tubo del Vortex se llama la fracción fría. En la mayoría de los usos, una fracción fría del 80% produce una combinación de caudal frío y de la temperatura que maximiza la refrigeración, o de Kcal/h, a la salida de un tubo Vortex. Mientras que las fracciones frías bajas (menos del 50%) producen temperaturas más bajas, sacrificando la fracción fría de circulación de aire para alcanzarlas.

La mayoría de los usos industriales requieren la refrigeración máxima y utilizan el Tubo Vortex de la serie 20010 la 21035.

Fijar un Tubo Vortex es fácil. Inserte simplemente un termómetro en el extracto de aire frío y fije la temperatura ajustando la válvula en extremo caliente. Se alcanza la refrigeración máxima (fracción fría del 80%) cuando la temperatura del aire frío es 25°C por debajo de la temperatura del aire comprimido.

Si usted está inseguro de los requisitos de flujo y de la temperatura, AIRTX recomienda la compra de un kit de AIRTX. Contiene un Tubo Vortex, un silenciador de aire frío, un filtro de línea de aire y todos los generadores necesarios para experimentar con la completa gama de circulaciones de aire y de temperaturas.

## TUBOS VORTEX AIRTX Y RECAMBIOS

20008	Vortex inox 220 l/min 100 kcal/h
20010	Vortex inox 280 l/min 150 kcal/h Amarillo Cap. Refrig.
21010	Vortex inox 280 l/min 150 kcal/h Verde máx. Frio
20015	Vortex inox 420 l/min 230 kcal/h Rojo Cap. Refrig.
21015	Vortex inox 420 l/min 230 kcal/h Blanco máx. Frio
20025	Vortex inox 700 l/min 380 kcal/h Azul Cap. Refrig.
21025	Vortex inox 700 l/min 380 kcal/h Gris máx. Frio
20035	Vortex inox 990 l/min 630 kcal/h Marrón Cap. Refrig.
21035	Vortex inox 990 l/min 630 kcal/h Beige máx Frio
20400	Kit vortex con 8 gener. silenciador, difusor y filtro.
23000	Silenciador p/frío modelos del 20010 al 35
23008	Silenciador p/frío para mod.20008
23001	Sienciador p/caliente modelos del 20010 al 35
23009	Sienciador p/caliente para mod.20008
24010	Generador (H) 280 l/min Refrigeración Amarillo
24011	Generador (L) 280 l/min Max. Temperatura Verde
24015	Generador (H) 420 l/min Refrigeración Rojo
24016	Generador (L) 420 l/min Max. Temperatura Blanco
24025	Generador (H) 700 l/min Refrigeración Azul
24026	Generador (L) 700 l/min Max. Temperatura Gris
24035	Generador (H) 990 l/min Refrigeración Marrón
24036	Generador (L) 990 l/min Max. Temperatura Beige
24400	Kit ocho generadores

Presión recomendada: 7 bar Presión máxima 10 bar

Cuerpo y protectores/silenciadores: Acero Inoxidable Aisi 314

Temperatura ambiental máx.: 280 °C Presión máx. ambiental 0,2 bar

Usar siempre aire comprimido filtrado (5 Micras) y exento de aceite.

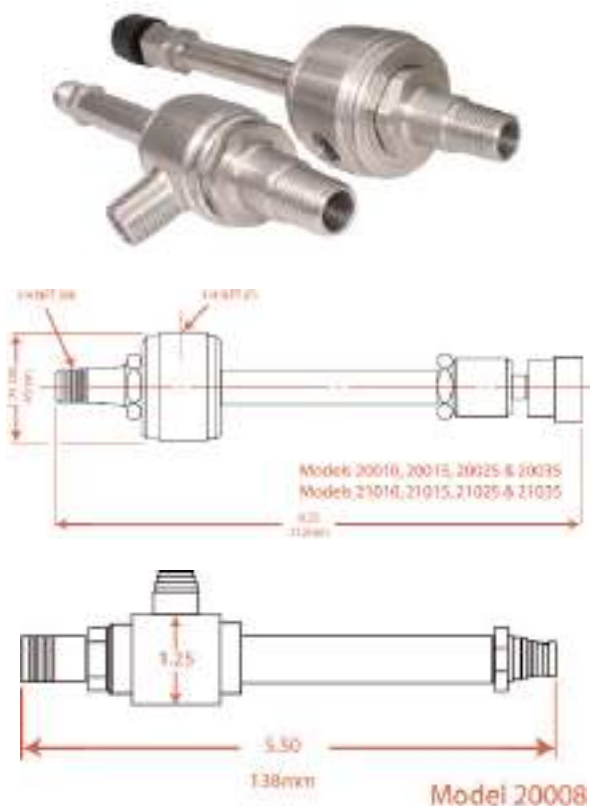

# AIRTX AIR GUNS: PISTOLAS REFRIGERACIÓN de Acero Inoxidable

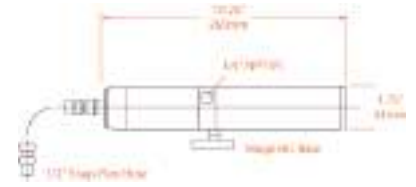

## AIRTX PISTOLAS DE REFRIGERACIÓN (AIR GUNS) DE ACERO INOXIDABLE - PREPARADAS PARA USAR, AIRE FRÍO PORTÁTIL

La Pistola de refrigeración o "Air Gun" es su aire frío portátil para mejorar operaciones de enfriamiento en maquinaria o puntos de refrigerado en muchos procesos industriales. Usando sólo aire comprimido, la Pistola de Refrigeración produce una corriente de aire frío 41°C por debajo de la temperatura del aire comprimido en red. Limpio, efectivo y directo. Instálela donde la necesite usando la base magnética y apuntando el difusor hacia el punto de trabajo. Fabricadas en Acero Inoxidable, tanto exterior como interiormente y ensambladas bajo un estricto control, las Pistolas de Refrigeración están fijadas para obtener el mejor rendimiento del Vortex. No se estropearán ni oxidarán bajo la influencia de chispas, refrigerantes, agua y otros elementos. (Consultar tablas de tolerancias)

La herramienta de seguridad:

- Aire frío para mecanizado de metales y aleaciones, composites, plástico, goma, madera, etc
- Perfecto para operaciones de torneado o corte, producción textil, perforación/fresado, afilado y torneado.
- Incrementa la producción, velocidad y calidad.
- Elimina el coste del líquido refrigerante, la contaminación y suciedad, la irritación de la piel, derrames en paredes, suelos y maquinaria.
- Mejora la vida de la herramienta, los ratios de producción, el acabado y las tolerancias.
- Elimina la microrrotura y las quemaduras.
- Sin líquidos, ozono, químicos o residuos.
- Enfía soldaduras, hot melt, colas y adhesivos.
- Test-térmico de componentes electrónicos, circuitos electrónicos y termostatos.
- Partes de dilatación. Refrigeración de máquinas de moldes, dispositivos de ultrasonidos.
- Refrigeración necesaria para la prevención de rotura en fresado y de rotura por calor o en perforaciones en plástico o sintéticos.

"FRACCIÓN FRÍA": Un término importante para entender el Tubo Vortex

La "Fracción Fría" es el porcentaje de entrada de aire comprimido que es lanzado a través del tubo de refrigerado. Es una regla general, cuanto menos volumen de aire frío le pida al Vortex, más frío el aire será. Usted ajusta la fracción de aire con el regulador. La fracción fría es también una función del tipo de generador que esté dentro del tubo Vortex. Dependiendo de: - Generador de Alta fracción - Generador de Baja fracción.

La mayoría de aplicaciones usan una Alta fracción (sobre el 50%). Un Vortex con una Alta fracción puede fácilmente darle salidas de 28 a 50°C por debajo de la temperatura de su comprimido. Altas fracciones le dan más volumen de aire, pero no con las más bajas temperaturas posibles.

La combinación de Alta fracción fría de volumen de aire y la temperatura mas fría produce la máxima capacidad de refrigeración, o el mayor grado de Kcal/Hr.

Una Baja Fracción Fría (sobre el 50%) significa menor volumen de aire saliendo muy frío. Cerrando el regulador, menor volumen de aire, mayor frío.

Así que recuerde, su máxima capacidad de Kcal/Hr (también llamada capacidad de refrigeración) ocurre con Vortex de Fracción Fría.

## PISTOLAS DE REFRIGERACIÓN

60015	Pistola inox refrig. "Air Gun" Magnética + difusor + 4 generadores
60051	Pist. inox refr. ajustable "Air Gun" Magn.+ difusor +4 generadores
60071	Pistola Compacta 226 l/min Magnética + difusor.
60061	Pistola ajustable 280 ó 424 l/min (2 gen.) Magn.+ difusor en Y

Usar siempre aire comprimido filtrado (5 Micras) y exento de aceite.  
Modelo 60015: Foto y dibujo técnico en la parte superior de la página.  
Modelos 60051; 60071 y 60061 debajo de este cuadro respectivamente.

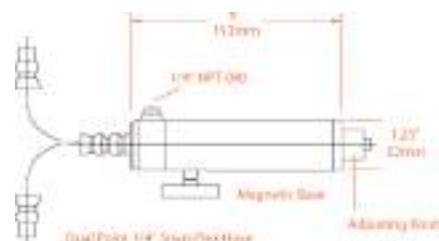
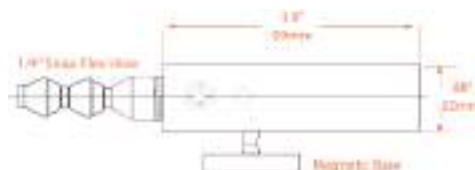
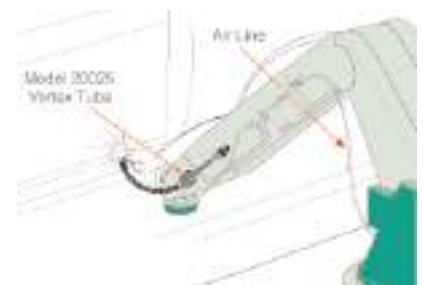
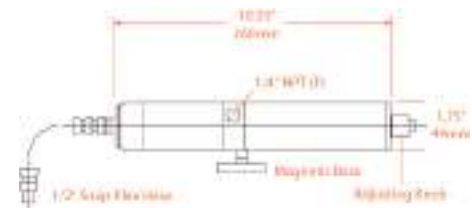

# REFRIGERACIÓN: Linea POLAR™ CONTROL CABINET COOLERS AIRTX

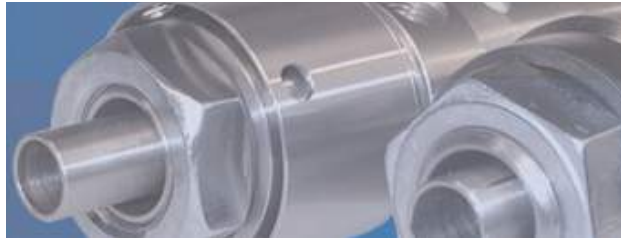

## AIRTX LÍNEA POLAR™ CONTROL CABINET COOLERS DE ACERO INOXIDABLE Y ALUMINIO - ESTANQUEIDAD Y FRÍO PARA CUADROS ELÉCTRICOS

Refrigerado de armarios eléctricos o carcasas de máquinas de contenido electrónico que precisen un ambiente por debajo de los 32°C, seco y libre de impurezas. Mucho más económico que los equipos de freón, es fácil de instalar, sin mantenimiento. Construido totalmente en Acero Inoxidable (otros competidores en aluminio) Con altas temperaturas, el bajón de rendimiento de la máquina o incluso su detención es debido a la subida de la temperatura por encima de los 35°C dentro de los cuadros eléctricos. Los componentes electrónicos pueden ser dañados y su sustitución es costosa, el tiempo de parón de la producción muy perjudicial y caro para la empresa. Los aparatos de freón ocupan más, tienen mayor coste y mantenimiento y fallan a menudo en condiciones de calor extremas. También la suciedad acumulada en interior de los cuadros y la humedad son un problema. El Cabinet Cooler de AIRTX refrigera, a la vez presuriza y desaloja el aire caliente del interior del cuadro eléctrico, siendo estas tres fases de comportamiento únicas y eficaces teniendo en cuenta que es un aparato tan pequeño y económico.

El CONTROL COOLER es de fácil instalación, sin CFC y equipos adicionales. Mantiene el cuadro por debajo 20°C del ambiente, frío, seco, libre de impurezas y polvo.

· Uso en cualquier lugar. Fabricado en A.INOX resistente a la corrosión, áreas de limpieza, golpes y peligros.

· Bajo coste, consumo y libre de mantenimiento. Sin partes móviles ni vibraciones.

· Variable capacidad de refrigeración (cabinas hasta 1,8x1,8x0,6 mts).

· Compacto para pequeñas o estrechas áreas de la factoría.

· Sin electricidad ni riesgo de explosión o inflamación · Sin interferencias RF/EMI.

· Controladas por unidad termostática (opcional).

· Sin ventiladores ni filtros.

· Silenciadores incorporados para una operación silenciosa.

USOS:

· Cabinas de NC/CNC · PC's industriales; PLC's · Instrumentos de medición o lectura y aparatos de grabado o filmación. · Cámaras de circuito cerrado.

· Controles de motor · Cámaras frigoríficas sector alimentario y otros · Cabinas eléctricas o de cualquier tipo a las que se quiera mantener un ciclo de temperatura.



## FAMILIA CONTROL CABINET COOLERS Y COMPLEMENTOS

<b>70008</b>	Control Cooler Inox + kit instalación 151 Kcal. 220 l/min
<b>70308</b>	Control Cooler 70008 + Kit + Termostato/ Electr. y Filtro
<b>70015</b>	Control Cooler Inox + kit instalación 277 Kcal. 420 l/min
<b>70315</b>	Control Cooler 70015 + Kit + Termostato/ Electr. y Filtro
<b>70025</b>	Control Cooler Inox + kit instalación 454 Kcal. 700 l/min
<b>70325</b>	Control C.70025 + Kit+ Termost/Electrov. y Filtro
<b>70035</b>	Control Cooler Inox + kit instalación 630 Kcal. 990 l/min
<b>70335</b>	Control C.70035 + Kit + Termost/Electrov. y Filtro
<b>70370</b>	KIT sistema termostático 1260 Kcal (2 ud. 70035 + acces.: Filtro, Electroválvula, Termostato y 2 Kit Instalación)

<b>75008</b>	Control Cooler Aluminio + kit instalación 151 Kcal. 220 l/min
<b>75015</b>	Control Cooler Aluminio + kit instalación 277 Kcal. 420 l/min
<b>75025</b>	Control Cooler Aluminio + kit instalación 454 Kcal. 700 l/min
<b>75035</b>	Control Cooler Aluminio + kit instalación 630 Kcal. 990 l/min

<b>70008x</b>	Control Cooler Inox 4/4x + kit instalación 151 Kcal. 220 l/min
<b>70015x</b>	Control Cooler Inox 4/4x + kit instalación 277 Kcal. 420 l/min
<b>70025x</b>	Control Cooler Inox 4/4x + kit instalación 454 Kcal. 700 l/min
<b>70035x</b>	Control Cooler Inox 4/4x + kit instalación 630 Kcal. 990 l/min

## COMPLEMENTOS DE ORIGEN AIRTX:

<b>90300</b>	Termostato tarado a 32°C AIRTX
<b>90300-1</b>	Termostato regulable (regulado a 32°C) AIRTX
<b>90301-1</b>	Electroválvula 1/4 N/C 220V/50Hz AC 1000 l/m AIRTX
<b>90302-1</b>	Electroválvula 3/8 N/C 220V/50Hz AC 2100 l/min AIRTX
<b>90190</b>	Filtro 1/4 5 micras 2100 l/m purga manual AIRTX
<b>90176</b>	Filtro 3/8 5 micras 4000 lts/min purga aut. AIRTX
<b>7000-14</b>	Kit instalación: Tubo, soportes y silenciador

## COMPLEMENTOS ALTERNATIVOS CDA:

<b>TER.90300-3</b>	Termostato mecánico a/c regulable de 0 a 60°C
<b>EN/C02-220</b>	Electroválvula 1/4 N/C 220V/50Hz AC 450 l/min
<b>EN/C03-200</b>	Electroválvula 3/8 N/C 220V/50Hz AC 800 l/min
<b>EN/C05-220</b>	Electroválvula 3/4 N/C 220V/50Hz AC 1100 l/min
<b>FFI02-5M</b>	Filtro 1/4 5 micras 850 lts/min purga s/aut.
<b>FFR02-5M</b>	Filtro Regulador 1/4 5 micras 850 lts/min s/aut.
<b>FFR04-5M</b>	Filtro Regulador 1/2 5 micras 2500 lts/min s/aut.

Usar siempre aire comprimido filtrado (5 Micras) y exento de aceite.



# REFRIGERACIÓN AIRTX: Línea POLAR™ CONTROL CABINET COOLERS de A.Inox. Recomendaciones técnicas



## AIRTX LÍNEA POLAR™ CONTROL CABINET COOLERS - CONSEJOS DE USO Y MONTAJE:

Primero dictamine exactamente qué modelo de Control Cooler es el más adecuado según las Kcal/hr que necesite para su cuadro (ver sección "Calculo aproximado...") Haga un agujero de unos 27mm a ser posible en la parte superior, así el Control Cooler podrá evacuar mejor el aire caliente concentrado en el interior del cuadro. Fíjelo bien con la tuerca pasamuros, asegúrese de que le llegue el caudal necesario para cada modelo y 7 bar de presión. Poner un prefiltro de 5 micras para la alimentación de aire comprimido y asegúrese que no llegue vapor de aceite. Una buena instalación en la línea de aire permite tener aire seco y limpio, evite la condensación.

Tape cualquier abertura que haya en el cuadro, elimine ventiladores, así evitaremos que entre la suciedad. Instale el tubo de plástico en la salida de aire frío y deslice el tubo hasta la base del cuadro, al final monte el silenciador que viene en dotación. Haga pequeños agujeros en el tubo de plástico para que el aire frío se reparta mejor por el interior del cuadro. El aire caliente tenderá a concentrarse en la parte superior del interior del cuadro y será desalojado por los agujeros del Control Cooler por el propio efecto de presión del mismo en el interior del cuadro. Se puede montar sin usar sistemas termostáticos convencionales pero AIRTX le ofrece por separado el termostato y la electroválvula para mantener la temperatura interior por debajo de los 32°C.

El Control Cooler AIRTX de acero inoxidable está diseñado y tarado de origen para suministrar la refrigeración máxima necesaria para mantener la temperatura interna deseada dentro del panel de control. A 7 bar y con un consumo de 700 lts/min, el modelo 70025 suministra 454 Kcal de refrigeración. Es el modelo más usado. Un compartimiento bien sellado es aún más eficaz, puesto que el aire frío entra solamente en la cabina y no se escapa hacia la atmósfera, generando un incremento en el uso del aire comprimido. Una cabina sellada también elimina la posible condensación que se forma en los componentes. En los modelos 700x la calidad del Acero y la válvula mantiene la integridad de un Nema 4, 4x o 12 de cabina. La construcción en acero permite su lavado. " UL Listing normativa para cabinas clase 4, 4x, 12".

El Control Cooler de AIRTX no tiene piezas móviles. Limpiamente, el aire comprimido circula por el tubo sin causar desgaste en las piezas lo que proporciona el mismo servicio durante un periodo indefinido de tiempo. Ocasionalmente puede ocurrir que entre suciedad, agua o aceite en el tubo desde el suministro de aire comprimido lo que puede repercutir en el funcionamiento. Cuando esto ocurre, simplemente se ha de sacar el generador, limpiar las piezas o sustituirlas, y volver a ajustarlas, colocando de nuevo firmemente la válvula de frío para que el generador quede perfectamente ajustado.

La temperatura que está fijada en el termostato de fábrica es de 32°C. En caso de termostato regulable se aconseja igualmente a 32°C. Esto se hace por dos motivos:

1. Si la temperatura fijada en el interior de la cabina es de 20°C por ejemplo, entonces en un día caliente de 37°C, podría ocasionarse condensación en la cabina.
2. La temperatura crítica para los controles eléctricos es de 35°C. Un 20% de estos controles queda dañado con temperaturas superiores a 35°C.

Una fijación de 32°C previene una condensación excesiva y conserva el aire. Por otro lado también mantiene un PH de humedad bajo, por debajo del 42%.

Para los Control Coolers sin termostato que están operativos continuamente, la condensación puede formarse en cualquier momento. Si esto ocurre, se ha de regular el aire comprimido a una posición inferior (3.5-4.2 bar). Esto hará que la temperatura interior suba y reducirá las gotas de agua fuera de la cabina mientras que el interior se mantiene perfectamente refrigerado. El conducto de vinilo agujereado en aquellas partes o elementos que propagan más calor evitará el derroche e energía.

Square meters	50°C	39°	28°C	17°C	6°C
1.49	126	88	38	13	13
2.79	280	202	113	38	25
2.97	330	227	139	38	25
3.72	405	280	176	38	25
4.65	555	353	227	75	38
5.6	655	454	280	126	50
6.50	756	530	328	151	50
6.69	781	555	353	176	50
7.80	907	655	403	189	50
8.92	1058	756	480	227	50
10.40	1210	882	554	252	50
11.71	1462	1033	655	328	63
13.38	1638	1159	730	365	76
14.86	1764	1310	832	416	88
17.84	2218	1612	1310	530	113

## CÁLCULO APROXIMADO PARA CABINET COOLERS

1. Calcule el área total del cuadro usando la siguiente fórmula:  
 $(2 \times \text{Ancho} + 2 \times \text{Profundidad}) \times \text{Alto} = \text{Area en Mts. del cuadro}$
2. Determine la temperatura interior midiendo la temp. máx. exterior. Ejemplo: En un día de 21°C la lectura de la temperatura interior del cuadro indica 43°C, añadir 4°C si los componentes electrónicos están operativos en un día de verano de 35°C o añadir más si es superior.
3. +32 °C es la temperatura de seguridad para muchos componentes electrónicos. Al mantener una temperatura alta evita condensación.
4. Restar la temperatura deseada de 32°C a la calculada en el paso 2 y así poder determinar la temperatura diferencial.
5. Use el área calculada en el paso 1 y compárelo con la columna de la izquierda de la tabla adjunta. Y lo mismo con el diferencial de temperatura del paso 4.
6. La intersección de esos dos datos le da las Kcal/hora requeridas para mantener la temperatura deseada en el interior del cuadro.
7. Determine qué Control Cooler es el que da suficiente volumen de Kcal/hr. ( consultar en la página anterior)



# SOPLADO - Boquillas AIRTX: Gama de boquillas de seguridad Modelo Hurricane™ patentado



## AIRTX BOQUILLAS DE SOPLADO HURRICANE™ Amplificación 25:1

Con la tecnología "Coanda", las boquillas de aire HURACÁN AIRTX lanzan un flujo de aire desde finas aberturas y arrastran el aire atmosférico, precipitándolo hacia la parte frontal de la boquilla y amplificando así el caudal hasta 25 partes de aire aspirado por una parte consumida (25:1)

Las Series 5 y 7, nuestras boquillas de seguridad patentadas. Las mejores en diseño y prestaciones.

Las boquillas AIRTX Series 5 y 7 (48005 Aluminio; 40005 Acero Inox.; 48007 Alum.; 40007 Inox.; 48107 Alum. y 40107 Inox.) son las mejores boquillas del mercado. Después de años de investigación, AIRTX ha desarrollado y patentado las boquillas de seguridad "definitivas". Concretamente, el modelo 48005 es la boquilla utilizada en la mayoría de aplicaciones. Rosca de conexión hembra de 1/4" y fabricada en aluminio, se han instalado AIRTX 48005 en cientos de miles de aplicaciones en todo el mundo. Aplicaciones en las que se ha reducido en más de un 70% el nivel de ruido y en más de un 50% el consumo energético. Las aletas protectoras evitan el contacto directo de la piel con los orificios de salida. El rebaje a mitad de los cinco "dedos" de la boquilla crea una película protectora que impide que las partículas sopladadas regresen en dirección a la boquilla, protegiendo de esta manera todo lo que quede detrás de ésta, en un ángulo aproximado de 210 grados. Con este diseño la boquilla cumple con la norma OSHA de seguridad, que indica que la presión de aire no debe sobrepasar 210 kPa (30psi) en contacto directo con la piel. También cumple con las disposiciones de la Directiva de máquinas CE en materia de ruido. Es la boquilla más pequeña del mundo que puede llegar a un caudal efectivo de hasta 24.000 lts/min.

ÚSELAS PARA LAS SIGUIENTES APLICACIONES:

· Eliminar agua de láminas de plástico o metal. · Expulsar astillas, virutas y residuos pequeños. · Limpiar zonas antes de proceder a su pintado. · Refrigeración de zonas. · Limpiar/refrigerar láminas de metal y marañas de papel/plástico. · Limpiar cintas de transporte. · Soportes multiboquillas p/soplados de estructuras complejas.

			<p><b>48005</b> Boquilla Seguridad Al."Hurricane" 1/4 H Amplificación 25:1 792 l/min a 5,5 bar</p> <p><b>40005</b> Boquilla inox Seguridad."Hurricane" 1/4 H Amplificación 25:1 792 l/min a 5,5 bar</p>
			<p><b>48107</b> Boquilla Seguridad Alum.Hurricane 1/2 H Amplificación 25:1 906 l/min a 5,5 bar</p> <p><b>40107</b> Boquilla Seguridad Alum.Hurricane 1/2 H Amplificación 25:1 906 l/min a 5,5 bar</p>
			<p><b>48002</b> Boquilla de Seguridad Al. 1/4 H 25:1 Amplificación 25:1 284 l/min a 5,5 bar</p> <p><b>40002</b> Boquilla inox de Seguridad 1/4 H 25:1 Amplificación 25:1 284 l/min a 5,5 bar</p>
			<p><b>48009</b> Boquilla Ajustable Al. 1/8 M Amplificación 25:1 424 l/min a 5,5 bar</p> <p><b>40009</b> Boquilla inox Ajustable Al. 1/8 M Amplificación 25:1 424 l/min a 5,5 bar</p>
			<p><b>48109</b> Boquilla Ajustable Alum. "Huracán" 1/2 M Amplificación 25:1 566 l/min a 5,5 bar</p> <p><b>40109</b> Boquilla Ajustable Inox. "Huracán" 1/2 M Amplificación 25:1 566 l/min a 5,5 bar</p>
			<p><b>48008</b> Boquilla Fija Mini Seguridad latón 1/8M Amplificación 25:1 255 l/min a 5,5 bar</p> <p><b>40008</b> Boquilla Fija Mini "Hurricane" Inox 1/8M Amplificación 25:1 293 l/min a 5,5 bar</p>
			<p><b>48002</b> Boquilla Fija Mini Seguridad latón 1/8M Amplificación 25:1 190 l/min a 5,5 bar</p>

# SOPLADO - Boquillas AIRTX: Datos técnicos, normativa y ahorro energético.

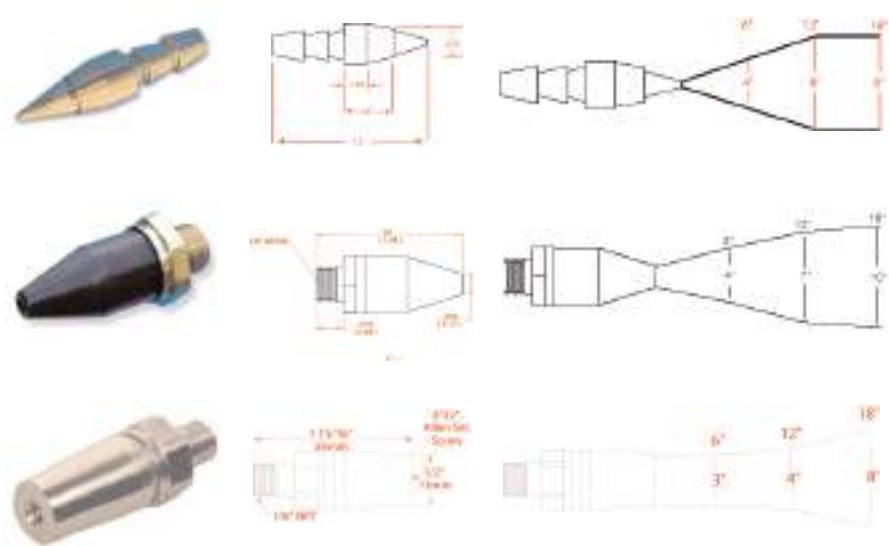

**48010** Boquilla Mini laton fija p/manguera 9mm  
Amplificación 25:1 255 l/min a 5,5 bar

**48006** Boquilla Caucho flexible 1/8M  
Amplificación 25:1 255 l/min a 5,5 bar

**48004** Boquilla Ajustable Al. 1/4 M 25:1  
Amplificación 25:1 424 l/min a 5,5 bar

## INFORMACIÓN TÉCNICA DE LAS BOQUILLAS DE SOPLADO:

MODELOS	Consumos a dif. presiones (lts/min)					Fuerza a diferentes distancias (Gramos)			
	2,8 bar	4,14 bar	5,5 bar	6,9 bar		2,8 bar	4,14 bar	5,5 bar	6,9 bar
<b>48005 / 40005</b> (Inox) Nivel sonoro: 70dBA	566	736	849	962	15cms...	482	862	1115	1266
					30cms...	431	811	1065	1217
					45cms...	330	684	963	1115
<b>48107 / 40107</b> (Inox)	650	792	906	991	15cms...	405	608	862	1166
					30cms...	355	634	811	1014
					45cms...	304	507	710	963
<b>48007 / 40007</b> (Inox)	255	368	425	538	15cms...	228	405	532	608
					30cms...	203	380	507	583
					45cms...	152	330	456	532
<b>48009 / 40009</b> (Inox) Nivel sonoro: 72dBA			507		15cms...	195	309	418	522
					30cms...	192	292	403	510
					45cms...	175	253	337	426
<b>48109 / 48009</b> (Inox)			507		15cms...	329	456	735	938
<b>48008 / 40008</b> (Inox) y <b>48010</b>	170	198	255	311	15cms...	114	155	210	294
					30cms...	101	144	203	279
					45cms...	94	132	190	270
<b>48006</b>	170	198	255	311	15cms...	114	155	210	294
					30cms...	101	144	203	279
					45cms...	94	132	190	270
<b>48004</b>			424		15cms...	304	406	507	558
					30cms...	279	380	456	532
					45cms...	235	330	450	435



## BOQUILLAS DE SOPLADO AIRTX: RECOMENDACIONES SOBRE AHORRO, ACÚSTICA Y SEGURIDAD (1)

Con nuestros diseños, las boquillas de seguridad AIRTX cumplen con la norma OSHA de seguridad, que indica que la presión de aire no debe sobrepasar 210 kPa (30psi) en contacto directo con la piel. También cumple con las disposiciones de la Directiva de máquinas CE en materia de ruido, que por regla general, indica que no se debe sobrepasar los 85 dBA durante cierto tiempo.

### AHORRO DE ENERGÍA

En soplado y concretamente en boquillas de seguridad, AIRTX no tiene rival. Si no lo cree, compare datos con otros fabricantes, si es que los consigue. Podemos demostrar que en algunos modelos, no sólo la incorporación de nuestras boquillas es más que aconsejable y su coste tiende a "cero" en poco tiempo e incluso una empresa puede plantearse el sustituir todas la boquillas de otra marca por las nuestras, aunque haya pasado poco tiempo desde su adquisición. Existe una creciente preocupación por reducir costes. Cada gasto se analiza, incluyendo los costes de energía, tanto por el factor económico como por el ecológico. Hay numerosas posibilidades de ahorrar la energía utilizada en relación al aire comprimido, en parte, eliminando fugas realizando periódicamente el mantenimiento de toda la generación y transporte de aire comprimido, pero principalmente mediante una utilización más eficaz. Un buen ejemplo es la utilización de boquillas de soplado AIRTX para la limpieza con aire comprimido. Además de reducir costes también se obtienen niveles de ruido considerablemente bajos y de seguridad altos.

Cuando se utiliza el aire comprimido para limpieza, impulsión o secado, se tiende a utilizar una tubería a escape libre. En la gran mayoría de los casos todo esto tiene como resultado un derroche de aire para un bajo rendimiento de la potencia de soplado. Un rendimiento eficaz es el que tiene en cuenta aspectos técnicos en los que intervengan boquillas de amplificación, distancia, ángulo de soplado e interacción con la superficie a tratar. Así se obtienen ahorros de energía de un 30 a un 70 % .

# SOPLADO - Complementos y Pistolas con boquillas. Seguridad y ahorro energético.



Ref.: 48808



Disponibles 3 modelos de pistolas de soplado:  
Aluminio económica; Plástico resistente y  
Metal cromada con pulsador superior.

- 48807 Pistola Aluminio c/Boquilla Reg. 48009
- 48808 Pistola Aluminio c/Boquilla Seg. 48005

- 48012 Pistola Plástico c/Boquilla Seg. 48007
- 48013 Pistola Plástico c/Boquilla Reg. 48009
- 48014 Pistola Plástico c/Boquilla Reg. 40009

- 48212 Pistola Cromada c/Boquilla Seg. 48007
- 48213 Pistola Cromada c/Boquilla Reg. 48009
- 48214 Pistola Cromada c/Boquilla Reg. 40009



Ref.: 48013



Ref.: 48213

## COMPLEMENTOS PARA BOQUILLAS:

- |          |                               |      |                          |
|----------|-------------------------------|------|--------------------------|
| 40001-6  | Latiguillo flexible 152mm 1/4 | -A6  | Extensión Aluminio 152mm |
| 40001-8  | Latiguillo flexible 202mm 1/4 | -A8  | Extensión Aluminio 202mm |
| 40001-12 | Latiguillo flexible 305mm 1/4 | -A12 | Extensión Aluminio 305mm |
| 40001-18 | Latiguillo flexible 457mm 1/4 | -A18 | Extensión Aluminio 457mm |
| 40001-24 | Latiguillo flexible 610mm 1/4 | -A24 | Extensión Aluminio 610mm |
| 40001-30 | Latiguillo flexible 762mm 1/4 | -A30 | Extensión Aluminio 762mm |
| 40001-36 | Latiguillo flexible 914mm 1/4 | -A36 | Extensión Aluminio 914mm |



- 38003 Distribuidor 4 salidas base magnética
- 38006-4 Racor rótula posicionador 1/4 MxH
- ME8220 Sonómetro medidor digital de 30 a 130 dbA

## BOQUILLAS, RECOMENDACIONES SOBRE AHORRO, ACÚSTICA Y SEGURIDAD (2)

### SEGURIDAD Y NORMATIVA

Cuando se trabaja con aire comprimido, deben tomarse ciertas precauciones para evitar que ocurran accidentes. Respeto absoluto a las indicaciones de máxima presión operativa, temperatura, carga, etc. El aire comprimido jamás debe entrar en contacto directo con la piel (corporal). Existen normativas de seguridad para la utilización del aire comprimido en muchos países. En la actualidad, la mayoría de países han establecido restricciones acerca de la cantidad de aire comprimido a la que puede estar expuesta directamente la piel. Los operarios utilizan a menudo pistolas para limpiarse el polvo y la suciedad después de la jornada laboral. La utilización del aire comprimido para este fin implica claramente el riesgo de aplicar el aire comprimido contra la piel, permitiendo que éste entre en contacto con la circulación sanguínea, provocando coágulos.

La seguridad en el puesto de trabajo viene regulada por la OSHA. OSHA es la abreviatura de "Occupational Safety and Health Administration". La utilización del aire comprimido se trata en el artículo 1910.242 b. Las boquillas AIRTIX no pueden obtenerse por completo. Por tanto, la presión acumulada nunca debe exceder los 210 kPa (30 psi). Lo que es más, la 1910.242 establece que debe proporcionarse algún tipo de método o aparato con objeto de evitar que las partículas o restos, independientemente de su tamaño, entren en los ojos o en la piel del operario o trabajador. Este protector anti restos, puede estar integrado o separado de la boquilla, como cuando se utilizan escudos o barreras. Generalmente hablando, la utilización de conos de aire de protección proporciona la protección adecuada para el operario, pero puede que sean necesarias pantallas o escudos para proteger a los trabajadores de la exposición a partículas o restos.

Las boquillas patentadas por AIRTIX modelos 48005, 48107 y 48007 así como las pistolas que incorporan estas boquillas están diseñadas para cumplir estas normativas. En la UE rige la Directiva de Maquinaria 98/37/CE.

### RUIDO

El oído humano es muy sensible. La pérdida de audición provocada por la exposición prolongada al ruido, a menudo implica la generación de impulsos nerviosos que se experimentan en forma de zumbido. La persona puede sufrir alucinaciones auditivas que se forman sin estimulación externa, por no decir la pérdida gradual e irreversible. Este fenómeno puede conducir a complicaciones psicológicas tan graves incluso como el daño físico.

### DISMINUCIÓN DEL RUIDO

Una mejor solución al problema es no permitir que este ruido se expanda en el ambiente. En la mayoría de los casos es posible reducir el ruido de los sistemas neumáticos utilizando silenciadores y boquillas de soplado. AIRTIX se ha especializado en este tipo de productos y ofrece una gama de productos única y patentada.

1. Las boquillas para aire comprimido pueden reducir los niveles de ruido a la mitad y al mismo tiempo, mejorar considerablemente la potencia de soplado, en comparación con el soplado de tubería a escape libre.
2. Las pistolas de seguridad que incorporan boquillas de soplado para la eliminación del ruido ahorran considerables cantidades de energía comparadas con las pistolas convencionales sin boquilla.

### PROGRAMAS PARA EL CONTROL SONORO

Se deben tomar medidas para reducir el ruido al nivel más bajo posible. Un programa de control de ruido debe ponerse en marcha si los niveles de ruido exceden los límites existentes. La normativa en materia de ruido indica respecto al valor inicial inferior que, si el nivel diario de exposición al ruido durante una jornada laboral es superior a 80 dB o el valor de parada de impulso es superior a 135 dB, se deberá informar a los empleados sobre los riesgos de la exposición al ruido, los valores inicial y límite, el resultado de las mediciones del ruido y las medidas que se adoptan. El valor inicial superior y el valor límite del nivel diario de exposición al ruido es de 85 dB, el nivel de presión acústica ponderado máximo es de 115 dB y el valor de impulso de parada de 135 dB. La acústica en el lugar de trabajo tiene un gran efecto en los niveles de ruido a los que están expuestos los empleados.



# SOPLADO - Barreras AIRTX: HURRICANE AIR KNIVES Barreras de aire Huracán 50:1



## AIRTX BARRERAS DE AIRE HURACÁN Amplificación 50:1

Con la tecnología "Coanda", las barreras de aire HURACÁN AIRTX lanzan un flujo de aire desde dos finísimas aberturas y arrastran el aire atmosférico de la parte superior e inferior de la barrera (ver dibujos), precipitándolo hacia adelante en la parte frontal de la barrera, uniéndose los dos flujos y amplificando así el caudal hasta 50 partes de aire efectivo por una parte consumida (50:1). Láminas (grosores): Incremente el flujo de la cortina de aire instalando láminas de ,008 cm adicionales.

### BARRERAS DE AIRE AIRTX. VENTAJAS Y USOS:

- Cortina de aire uniforme. · Hasta 50:1 Amplificación flujo de aire. · Costes iniciales y operatividad bajos. · Reducción alta del ruido. · Fácil de controlar el flujo/fuerza.
- Apagado/encendido instantáneo. · No hay tanto consumo de aire comprimido por culpa de conductos chapuceros. · Sin mantenimiento ni necesidad de recambios.
- Sin electricidad ni peligro de explosión. · Sin RF/EMI interferencias. Nivel sonoro modelo 86006: 69 dBA.

### ÚSELAS PARA LAS SIGUIENTES APLICACIONES:

- Eliminar agua de láminas de plástico o metal. · Sacar astillas, virutas y residuos pequeños. · Limpiar zonas antes de proceder a su pintado.
- Crear una "Cortina de Aire" entre procesos. · Refrigeración de zonas. · Limpiar/refrigerar láminas de metal y marañas de papel/plástico. · Limpiar cintas de transporte.
- Neutraliza la energía estática a la vez que se limpia. (Ver el apartado de Eliminación estática) · Secar quesos después del tratamiento antimoho.
- Secar alimentos como verduras, frutas, frutos secos antes del precintado, etc

Fuerza (150mm distancia del objetivo x una superficie de 100mm<sup>2</sup>) a 2,8 bar - 254 gr; a 4,1 bar - 583 gr; a 5,5 bar - 760 gr; a 6,9 bar - 938 gr

### FAMILIA BARRERAS HURACÁN (Consumos a 5,5 bar)

<b>86006</b>	Barrera Hurricane Al.152mm 50:1	850 l/min
<b>86012</b>	Barrera Hurricane Al.305mm 50:1	1700 l/min
<b>86018</b>	Barrera Hurricane Al.457mm 50:1	2550 l/min
<b>86024</b>	Barrera Hurricane Al.610mm 50:1	3400 l/min
<b>86030</b>	Barrera Hurricane Al.762mm 50:1	4250 l/min
<b>86036</b>	Barrera Hurricane Al.914mm 50:1	5100 l/min

Bajo pedido se pueden suministrar en Acero Inox. A316.

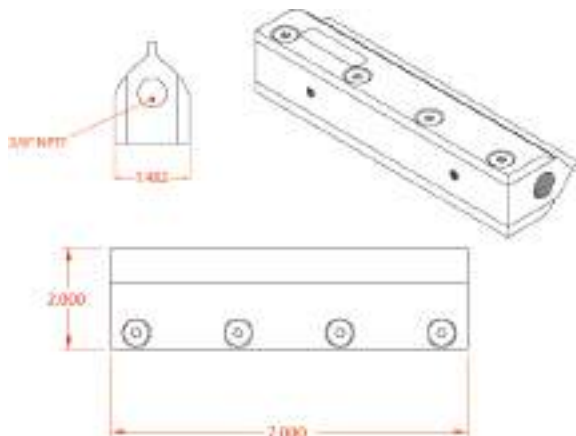
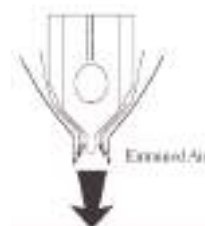

**Aplicaciones p/barreras AIRTX:** Secado de frutas y hortalizas, botellas y latas de conserva. Limpieza de astillas y polvo en cintas transportadoras. Limpieza de azúcar en botes. Refrigeración de bollería. Antiestática plásticos... Limpieza/secado en fabricas de tablas, cristales y muebles (superficies lisas), antes y después manipulación o precintado.



# SOPLADO AIRTX: Barreras de aire Standard amp.25:1



## AIRTX BARRERAS DE AIRE STANDARD Amplificación 25:1

Con la tecnología "Coanda", las barreras de aire Standard y Slimline AIRTX lanzan un flujo de aire desde una finísima abertura y arrastran el aire atmosférico de la parte superior (ver dibujos), precipitándolo hacia la parte inferior de la barrera, amplificando así el caudal hasta 25 partes de aire aspirado por una parte consumida (25:1).  
Aplicaciones: Igual que las barreras Huracán (Ver pág. anterior). Recambio láminas disponibles en plástico o A.Inox. La barrera Standard también se usa para acompañar a los puertos de Ionización para la eliminación antiestática.

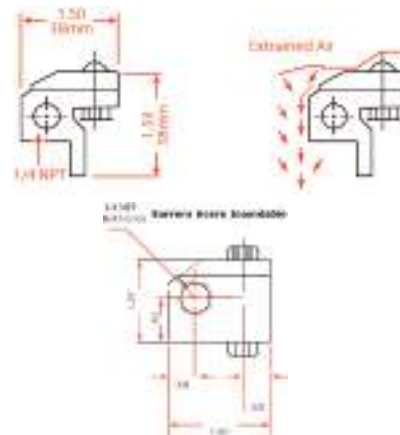

**MODELOS** (Consumos a 5,5 bar) Nivel sonoro modelos 85006 y 85012: 72 dBA

<b>85003</b>	Barrera de aire Al.76mm 50:1 340 l/min	<b>80003</b>	Barrera inox de aire 76mm 25:1 420 l/min
<b>85006</b>	Barrera de aire Al.152mm 25:1 680 l/min	<b>80006</b>	Barrera inox de aire 152mm 25:1 680 l/min
<b>85012</b>	Barrera de aire Al.305mm 25:1 1360 l/min	<b>80012</b>	Barrera inox de aire 305mm 25:1 1360 l/min
<b>85018</b>	Barrera de aire Al.457mm 25:1 2038 l/min	<b>80018</b>	Barrera inox de aire 457mm 25:1 2038 l/min
<b>85024</b>	Barrera de aire Al.610mm 25:1 2717 l/min	<b>80024</b>	Barrera inox de aire 610mm 25:1 2717 l/min
<b>85030</b>	Barrera de aire Al.762mm 25:1 3396 l/min	<b>80030</b>	Barrera inox de aire 762mm 25:1 3396 l/min
<b>85036</b>	Barrera de aire Al.914mm 25:1 4075 l/min	<b>80036</b>	Barrera inox de aire 914mm 25:1 4075 l/min

Ref. Recambio Láminas (0,07mm Espesor): 85000-3; 85000-6; 85000-12; 85000-18; 85000-24; 85000-30; 85000-36.

# Barreras de aire SLIMLINE Un 30% de menor consumo con igual amplificación 25:1



## FAMILIA BARRERAS SLIMLINE

<b>82003</b>	Barrera Slimline Al.76mm 25:1 255 l/min a 5,5 bar
<b>82006</b>	Barrera Slimline Al.152mm 25:1 509 l/min a 5,5 bar
<b>82012</b>	Barrera Slimline Al.305mm 25:1 1019 l/min a 5,5 bar
<b>82018</b>	Barrera Slimline Al.457mm 25:1 1528 l/min a 5,5 bar
<b>82024</b>	Barrera Slimline Al.610mm 25:1 2037 l/min a 5,5 bar
<b>82030</b>	Barrera Slimline Al.762mm 25:1 2547 l/min a 5,5 bar
<b>82036</b>	Barrera Slimline Al.914mm 25:1 2700 l/min a 5,5 bar

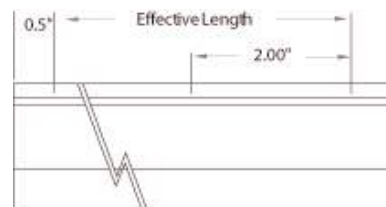
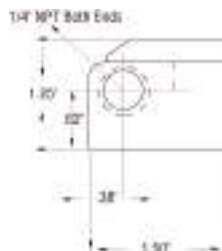

# AIR JETS Ajustables

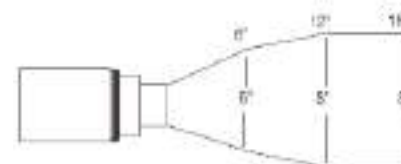

## AIR JETS AJUSTABLES

### VENTAJAS:

- Costes iniciales y de operatividad bajos.
- Apagado/encendido instantáneo. Regulable.
- Sin mantenimiento ni necesidad de piezas de recambio.

### APLICACIONES:

- Desalojo de salientes de maquinarias de moldura y de imprenta.
- Limpieza de astillas, virutas y residuos pequeños.
- Transporte de aire, polvo y fibras.
- Limpiar zonas antes de proceder a su pintado.
- Refrigeración de zonas.
- Limpiar/refrigerar láminas de metal y marañas de papel/plástico.
- Limpiar/refrigerar cintas transportadoras.

<b>38038</b>	Air jet de latón 1/8 H Amplific.25:1 509 lts/min
	Caudal efectivo cercano a los 13.000 lts/min
<b>38044</b>	Air jet lineal latón 1/8 H Ampl.25:1

Ideal para soplado en intersticios y recovecos de máquinas, moldes o carcasas. Gran caudal. Air jet lineal usado para hacer el vacío en pequeños espacios y cabinas. Liberar de gases espacios cerrados. Transporte neumático de pequeños materiales.

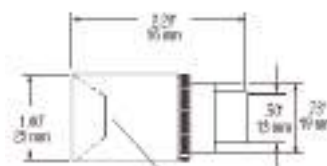
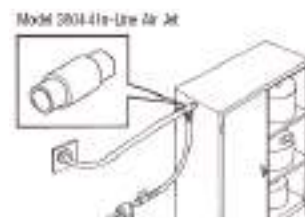

### INFO TÉCNICA DE LOS AIR JETS:

MODELOS.	Rosca H.	Fuerza hasta objetivo a dif. presiones (Gramos)				
		Distancia 2,8 bar	4,14 bar	5,5 bar	6,9 bar	
38034 / 38044 Nivel sonoro: 76 dBA	1/8"NPT	15 cm	190	299	418	563
		30 cm	175	292	418	542
		45 cm	142	236	347	441



# SOPLADO AIRTX: AIR SAVER WEDGE™ Boquilla plana



## AIRTX AIR SAVER WEDGE™ Boquilla plana

Con una amplificación de aire de 25:1, un diseño especial y compacto fabricado en una sola pieza, sin tornillos ni partes móviles y una excelente calidad de aluminio compactado o acero inoxidable AISI316 hacen de la Boquilla plana AIRTX una herramienta precisa y robusta para su aplicación de soplado con gran volumen de aire. Úsela para desplazar o quitar partes de moldes o procesos de estampación. Soplado de virutas, polvo, ribetes, trozos de metal, etc. Limpieza antes de pintar. Refrigeración de extrusiones. Limpieza de cristales y superficies lisas. Dos medidas en disponibilidad de 5 y 10 cm de ancho. Modelos Hurricane disponibles.

### VENTAJAS:

- Amplificador de aire de 25:1. Costes iniciales y de operatividad bajos., reducción entre un 30% y un 50%.
- Máxima propulsión de cualquier boquilla. Flujos desde 20.000 hasta 40.000 lts/min sólo con ,5 bar de presión.
- Fácil de controlar la fuerza/flujo. Apagado/Encendido instantáneo.
- Reúne las normativas OSHA de ruidos y los requerimientos de presión.
- Sin mantenimiento, ni piezas de recambio, ni vibración. Sin electricidad ni peligro de explosión. Libre de RF/EMI interferencias.
- Reduce los niveles de ruido de las líneas de aire en 30 DbA. Provee un flujo alto de aire para impresiones, chorros de arena, secados y partes salientes.
- Soportes múltiples en aluminio o acero Inox. disponibles.

### FAMILIA BOQUILLAS PLANAS

<b>38050</b>	Boquilla Plana 5cm Al. 1/4 H 25:1 792 l/min
<b>30050</b>	Boquilla inox Plana 5cm Al. 1/4 H 25:1 792 lts/min
<b>38150</b>	Boquilla Plana Hurricane 5cm Al. 1/4 H 25:1 1415 l/min
<b>30150</b>	Boquilla inox Plana Hurricane 5cm 1/4H 25:1 1415 l/min
<b>38054</b>	Boquilla Plana 10 cm Al. 1/4 H 25:1 1588 l/min
<b>30054</b>	Boquilla Plana Inox 10 cm 1/4 H 25:1 1588 l/m
<b>38154</b>	Boquilla Plana Hurricane 10 cm Al. 1/4 H 25:1 2547 l/m
<b>30154</b>	Boquilla inox Plana Hurricane 10cm 1/4H 25:1 2547 l/m

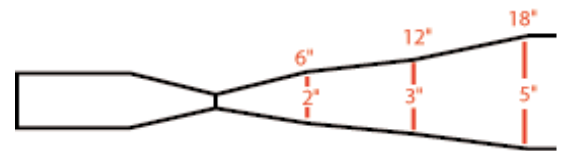
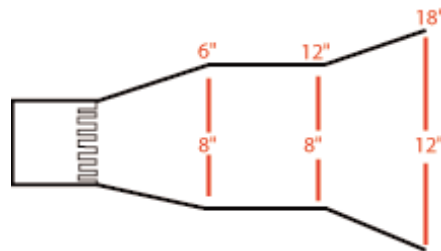

### INFORMACIÓN TÉCNICA DE LAS BOQUILLAS DE SOPLADO:

Nivel sonoro: 74 dBA

MODELOS (2 Med.)	Ancho	Largo	Alto	Rosca H.	Consumos a dif. presiones (lts/min)				Fuerza empuje a diferentes distancias (Gramos)				
					2.8 bar	4.14 bar	5.5 bar	6.9 bar	2.8 bar	4.14 bar	5.5 bar	6.9 bar	
<b>38050 / 30050 (Inox)</b>	51mm	51mm	12,7m	1/4"NPT	453	623	794	906	15cms...	571	800	971	1114
									30cms...	400	629	829	1000
									45cms...	350	486	686	857
<b>38150 / 30150 (Inox)</b>	51mm	51mm	12,7m	1/4"NPT	509	1132	1415	1641	15cms...	1142	1600	1943	2228
									30cms...	800	1257	1657	2000
									45cms...	571	971	1371	1714
<b>38054 / 30054 (Inox)</b>	51mm	102mm	12,7m	1/4"NPT	906	1246	1588	1812	15cms...	1314	1828	2228	2571
									30cms...	914	1457	1914	2314
									45cms...	657	1114	1571	1971
<b>38154 / 30154 (Inox)</b>	51mm	102mm	12,7m	1/4"NPT	1471	1981	2547	2943	15cms...	1314	1828	2228	2571

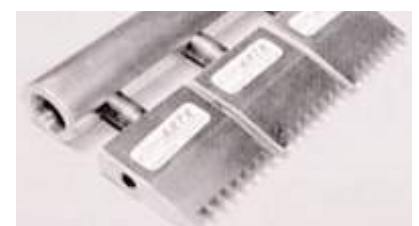
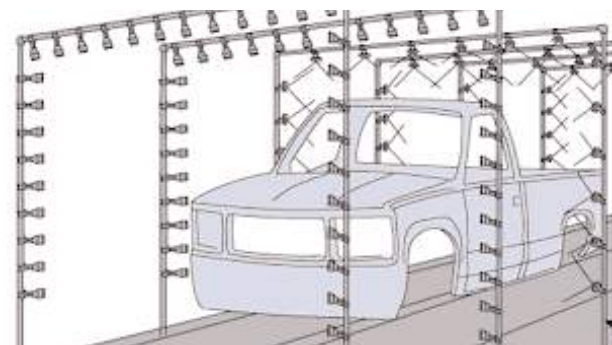

# SOPLADO AIRTX: AMPLIFICADORES DE AIRE AJUSTABLES HURRICANE



## AIRTX AMPLIFICADORES DE AIRE AJUSTABLES HURRICANE

Con la tecnología "Coanda", los amplificadores de caudal AIRTX lanzan un flujo de aire desde una finísima abertura y arrastran el aire atmosférico de la parte posterior (ver dibujo), precipitándolo hacia la parte delantera, amplificando así el caudal hasta 25 partes de aire aspirado por una parte consumida (25:1). Es el producto más clásico y visualmente más claro para la constatación del efecto "Coanda" ...

### VENTAJAS:

- Costes iniciales y de operatividad bajos. Apagado/encendido instantáneo. Sin mantenimiento ni necesidad de piezas de recambio.
- No hay electricidad ni peligro de explosión. Sin RF/EMI interferencias. Sin vibraciones. Ensamblado en metal, Aluminio o Acero Inoxidable.
- Modelo 15030 con caudal de aspiración 21.250 lts/min a 5,5 bar. Se puede ajustar flujo/fuerza.

### APLICACIONES:

- Desalajo de partes salientes de las maquinarias de moldura y de imprenta.
- Desplazar y aspirar humo, astillas, virutas y residuos pequeños.
- Transporte de aire, polvo y fibras.

## FAMILIA AMPLIFICADORES DE AIRE

15008	Amplif. aire ajustable 32mm 1/4" 12:1	255 l/min
15015	Amplif. aire ajustable 50mm 3/8" 20:1	370 l/min
15025	Amplif. aire ajustable 64mm 3/8" 22:1	550 l/min
15030	Amplif. aire ajustable 100mm 1/2" 25:1	850 l/min
10008	Amplif. inox aire ajustable 32mm 1/4" 12:1	255 l/min
10015	Amplif. inox aire ajustable 50mm 3/8" 20:1	370 l/min
10025	Amplif. Inox aire ajustable 64mm 3/8" 22:1	550 l/min
10000-30	Soporte para modelo 15008	
10000-31	Soporte para modelo 15015	
15008R	Reductor p/modelo 15008	
15015R	Reductor p/modelo 15015	

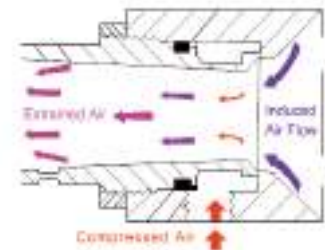

Modelos	A	B	C	D	E	Consumo tarado a 5,5 bar + ratio Amplif.
15008 / 10008	32 mm	50 mm	67 mm	26 mm	1/4 NPT	424 l/min 12:1
15015 / 10015	50 mm	76 mm	83 mm	27 mm	3/8 NPT	707 l/min 20:1
15025 / 10025	64 mm	94 mm	94 mm	30 mm	3/8 NPT	1273 l/min 25:1
15030	101 mm	127 mm	127 mm	38 mm	1/2 NPT	1698 l/min 30:1

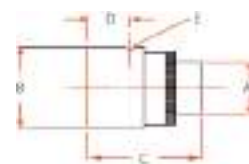

## GATE AIR WIPES™ Aros de soplado



### GATE AIR WIPES™ - AROS DE SOPLADO

El Aro de soplado está compuesto por dos barreras de aire curvadas a 180° y unidas por dos puntos de fácil apertura. Es un elemento que hace un fuerte soplado a 360° y en una dirección. Amplifica el caudal con un ratio de 25:1.

### ÚSELOS PARA LAS SIGUIENTES APLICACIONES:

- Limpieza de cualquier extrusión en continuo.
- Eliminar agua de láminas de plástico o metal.
- Limpiar tubos antes de proceder a su pintado.
- Refrigeración de zonas.
- Limpiar/refrigerar láminas de metal, aluminio.
- Limpiar burletes de goma (para puertas)
- Limpiar tuberías de cobre o metal.

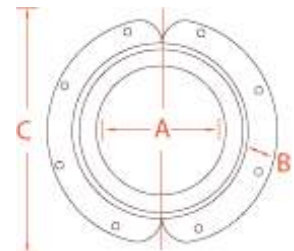

### INFORMACIÓN TÉCNICA DE LOS AROS DE SOPLADO:

MODELOS (5 Med.)	A	B	C	Rosca H.	Consumos a dif. presiones (cfm y lts/min)			
					2,8 bar	4,14 bar	5,5 bar	6,9 bar
16101	25mm	25mm	76mm	1/8"NPT	12	16	20	26
16102	50mm	25mm	76mm	1/8"NPT	18	22	26	30
16103 / 10103 (Inox)	76mm	38mm	152mm	1/4"NPT	679	792	905	1075
16105 / 10105 (Inox)	127mm	38mm	203mm	1/4"NPT	1075	1358	1528	1754
16107 / 10107 (Inox)	178mm	38mm	254mm	1/4"NPT	1584	1981	2264	2547



# ANTIESTÁTICA AIRTX: Dispositivos de Ionización



## AIRTX ELIMINACIÓN ESTÁTICA

La electricidad estática puede causar peligrosas descargas. Partículas de polvo y suciedad se adhieren a las superficies o bien partículas de plástico o papel se pegan a las máquinas. Barreras y pistolas + generador de ionización, crean campos de iones positivos y negativos que eliminan la estática en la superficie a tratar, cargada positiva o negativamente y la limpian simultáneamente. La eliminación estática de AIRTX es usada en muchas industrias para eliminar polvo y neutralizar la estática.

### ¿POR QUÉ ESTÁTICA?

Mucha gente asocia la estática con tocar una puerta o una fuente de agua en invierno y recibir un chispazo. Normalmente no es peligroso porque tiene un bajo amperaje. Con baja humedad, estos voltajes de estática pueden superar los 20.000 V. En aplicaciones industriales la estática es producida por aislamiento o materiales no conductibles rozándose juntos bajo una determinada presión. Cuando los materiales aislantes están separados, campos de carga solamente positiva o solamente negativa se forman y producen estática. Estos campos suelen formarse en materiales sintéticos como el plástico, nylon, cera, papel, polyester, PVC pero también en pelo, lana, piel, aluminio, madera o caucho entre otros. El amontonamiento de iones en esos campos positivos o negativos están determinados por el material, la humedad y la distancia. Una operador debe considerar reducir la velocidad para crear menor estática. P.ejemplo: Coger hojas individualmente cuando están amontonados es casi imposible si existe un vínculo de estática entre ellas. Amontonar aluminio después de haberse cargado de estática en una cinta transportadora es casi imposible hasta que la estática es minimizada. Pintar un vehículo o una pieza de plástico es difícil hasta que no se rompe el vínculo estática-polvo y se obtiene un acabado mejor. La estática causa una mala impresión en papel, etiquetas o superficies, queda borroso y debe neutralizarse.

Las botellas de plástico podrían saltar de la cinta transportadora a menos que reciban un baño de agua que reduzca la estática.

¿Qué pasa con los operarios? Tocar pomos de puertas cargados estáticamente no es bueno para recibir shocks cada vez que se toca algo de la cadena de producción. En general, la estática y la producción no son buenos compañeros.

### POR QUÉ PRODUCTOS AIRTX PARA NEUTRALIZAR LA ESTÁTICA?

Por su sencillez y versatilidad. Facilidad de montaje y buena relación calidad-precio. También por la protección de las puntas de acero, al estar montadas en un plano inferior las aíslan de golpes y son más resistentes. También los generadores son de máxima durabilidad y robustez. En otros fabricantes los emisores son intercambiables y se rompen con facilidad. Comprando equipos AIRTX usted ahorrará a largo plazo.

#### FAMILIA ANTIESTÁTICA AIRTX

55003	Puerto ionizador 76 mm
55006	Puerto ionizador 152 mm
55012	Puerto ionizador 305 mm
55018	Puerto ionizador 457 mm
55024	Puerto ionizador 610 mm
55030	Puerto ionizador 762 mm
55036	Puerto ionizador 914 mm
55503	Puerto ionizador 76 mm + Barrera aire 85003
55506	Puerto ionizador 152 mm + Barrera aire 85006
55512	Puerto ionizador 305 mm + Barrera aire 85012
55518	Puerto ionizador 457 mm + Barrera aire 85018
55524	Puerto ionizador 610 mm + Barrera aire 85024
55530	Puerto ionizador 762 mm + Barrera aire 85030
55536	Puerto ionizador 914 mm + Barrera aire 85036
50002-1	Generador 6000V 220v/50Hz 2 tomas
50000-1	Generador 7500V 220v/50Hz 4 tomas
50003	Pistola antiestática manual
50006	Punto fijo continuo antiestático
50005	Tester electrónico de estática
50025	Lápiz detector de estática



#### VENTAJAS ELEMENTOS DE ANTIESTÁTICA AIRTX

Neutralizar estática y sacar la suciedad al mismo tiempo con un mínimo consumo de aire y caudal de aire regulable. · Anti-shocks, sin radioactividad en la fuente de ionización. Libre de mantenimiento, fuerte y fiable para usos industriales. Silencioso, cumple normativas OSHA. Indicador luminoso para los puertos. Generadores con 4 modelos Standard en stock: 7500/6000 Volt. 115/230V · Generador de 6000 Volt con un 40% más de ionización que otros fabricantes que usan generadores de 5 Kv. Especialmente designados para prevenir la concentración calorífica, proveyendo de mayor vida y capacidad.



#### NEUTRALICE LA ESTÁTICA EN :

- Áreas de pre-pintado .
- Alimentadores de hojas, Enrolladores, Amontonadores, Separadores.
- Lentas ópticas, letreros, rótulos, etc.
- Embalaje de materiales.
- Transportadores neumáticos.
- Inyección de moldes.
- Herramientas de corte.
- Secadores de tinta en papel, textil o equipamiento.
- En guías de rollos o enrolladores en maquinaria de tratamiento de papel o plástico.
- Ensamblaje de componentes electrónicos o bandejas de alimentación.

#### INFORMACIÓN TÉCNICA DE LOS PUERTOS DE IONIZACIÓN

Voltaje operativo: 6000V Max Temp. 185°F / 85°C.  
Emisiones EMI/RFI: El cable cumple con la normativa internacional.  
Carcasa: Extrusión de aluminio Peso: 25 gramos x cada 30,5 cm de barra.  
Ozono: Emisiones muy por debajo de standards internacionales 0.1 PPM  
Puntas en Ac. Inoxidable aisladas de la bobina. Tocarlas no causa un shock.  
Energía por cada punta: 0.15 milijulios.



# ANTIESTÁTICA AIRTX: Consideraciones técnicas

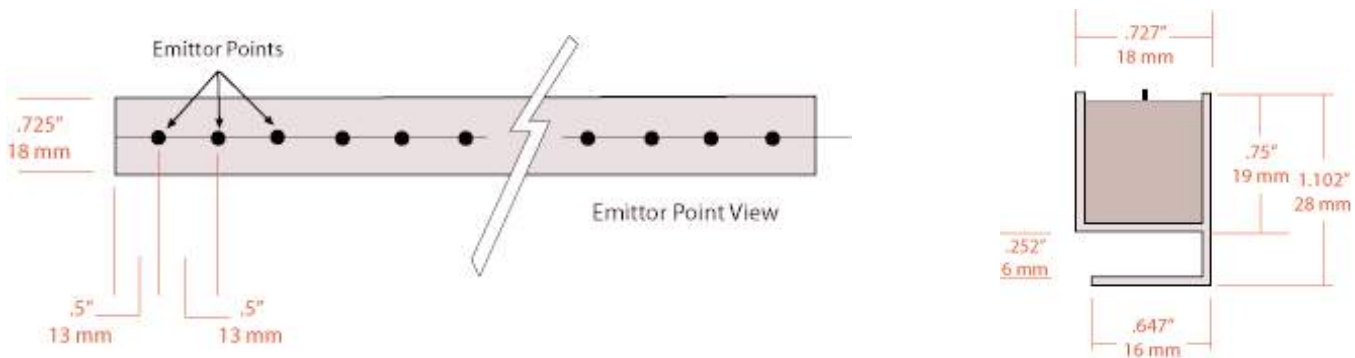

## MONTAJE Y UTILIZACIÓN:

Tenga en cuenta siempre que una unidad de eliminación estática, ya sea una barrera de aire o una pistola o punto fijo de soplado debe alimentarse con un generador enchufado a la corriente. Dicho generador puede alimentar dos o cuatro equipos. Hay dos modelos, 6000 Volt. (2 tomas) ó 7500 Volt. (4 tomas) Una vez esté funcionando la carga positiva-negativa de iones desplazados desde el componente AIRTX tiene una vida de 2 segundos en la atmósfera y un alcance de 1,5 metros. Con la barrera o la pistola (a 2 bar es suficiente) interactuando con el puerto ionizador obtenemos un alcance efectivo de 6 metros. La turbulencia creada por el abanico de aire causa que los iones choquen entre sí y que la distancia se vea reducida a 3-4 metros. Aún así se aconseja una exposición no inferior a los 5cm del objetivo para obtener un rendimiento óptimo.

Procurar siempre que no haya objetos, elementos o tomas de masa y derivación de electricidad cercanos al equipo (Como mínimo a 2 mts de distancia). Recuerde que para cada barrera de aire de la serie 85 tenemos su puerto de ionización serie 55, cuando pida uno, debe añadir el otro al pedido correspondiente. Sugerimos una alimentación neumática por ambos lados de la barrera cuando ésta sobrepase los 40 cm de longitud.

Para más información pueden dirigirse a nuestro departamento técnico: [consultas@componentesdelaire.com](mailto:consultas@componentesdelaire.com) y proponer su problema o consulta.

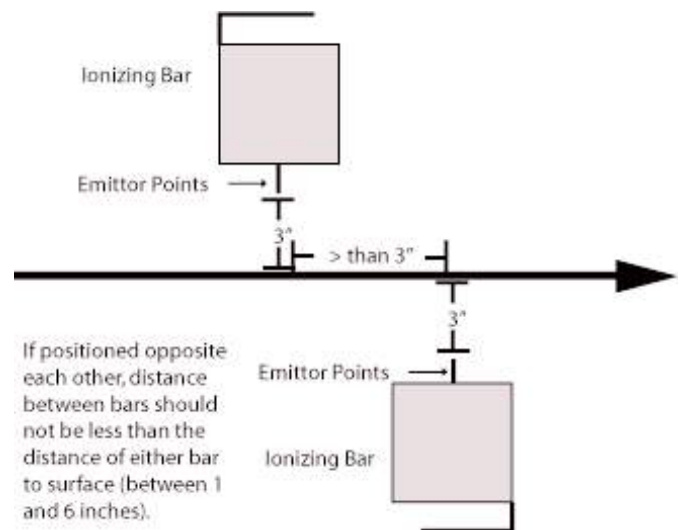
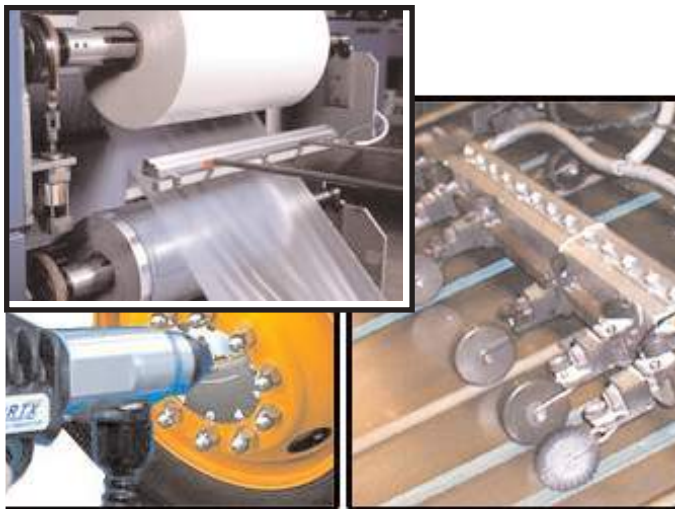

## POSICIONAMIENTO CORRECTO PARA LOS PUERTOS DE IONIZACIÓN :

La posición correcta es relativa al problema...  
 Pejemplo: Se recomienda la colocación inmediatamente antes del área de manipulación sobre el área afectada, sin interferencias, procesos ni desplazamientos que puedan recargar de nuevo el producto.  
 Velocidad de desplazamiento del material máxima (400 mts/min) — A mayor velocidad, mayor esfuerzo antiestático.  
 Conductividad y densidad del material. A mayor densidad molecular, mayor dificultad para realizar la descarga.

Toma tierra — Vitalmente importante la correcta conexión de las barras en el generador y que éste, a su vez, también descargue en la red.  
 En caso contrario no funcionarán bien y su vida útil disminuirá.

Tal como muestran los dibujos:  
 La distancia óptima desde el objetivo a neutralizar es entre 50 y 100 mm.  
 Los puertos no deben enfrentarse cuando hay que poner uno en cada lado del material. En ese caso uno debe alejarse lateralmente del otro a una distancia mayor de 75mm (entre 25 y 150mm)

Evitar la proximidad con Toma-tierras de la máquina – Los objetos que puedan hacer "Masa" distorsionarán la "corona" del puerto y reducirán su eficiencia.

**PRECAUCIÓN:** Estos equipos **NO** deben ser usados en áreas de vapor.

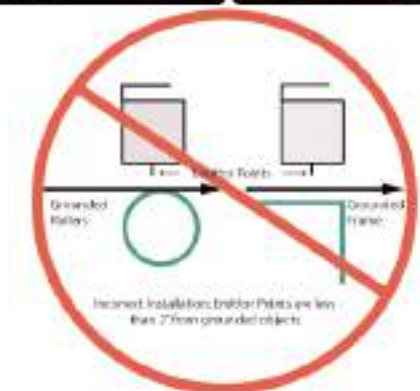

### Correct Installation

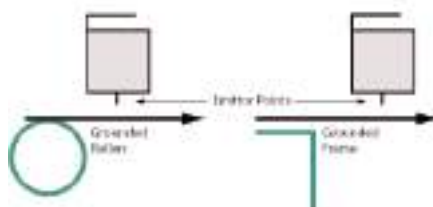

# ASPIRACIÓN Y TRANSPORTE DE SÓLIDOS AIRTX: Conveyvac™



## CONVEYVAC - ASPIRACIÓN Y TRANSPORTE NEUMÁTICO DE SÓLIDOS

CONVEYVAC: Aspiración de sólidos. Alto volumen recogido de materiales. Usado en la industria del plástico, madera, farmacéutica y alimentaria. Amplificación de aire 9:1 Recomendado para el transporte y trasvase de material hasta 135mm de diámetro o longitud. Sin límites de distancia, se pueden intercalar varios Conveyvac hasta conseguir que el producto llegue al destino, por más lejos que esté, en detrimento del consumo de aire.

Para el trasvase de material entre maquinaria de una nave industrial, suministramos también las mangueras para el transporte : antiestáticas, atóxicas y transparentes. Para el correcto montaje se ha de visualizar en todo momento cómo va circulando el material y dónde debemos intercalar otro Conveyvac cuando el material pierde velocidad.

Aumentaremos en poder de succión considerablemente con respecto a los demás sistemas de aspiración. Una instalación con Conveyvac no tiene partes móviles y sólo funciona con aire comprimido. El producto seco pasa limpiamente a través de él con suma rapidez y no hay riesgo de explosión por concentración de gases, ya que en todo momento hay contacto atmosférico entre la toma de aspiración y el final de deyección. Estos equipos funcionan a una presión de 5,5 bar y recomendamos siempre Instalar prefiltros de 5 micras en la alimentación de aire.



**Gama STRONGMAN™ : 100% Mayor capacidad de vacío, mayor temperatura (hasta 250°C), roscados.**

## GAMA CONVEYVAC

98004	Conveyvac aspiración 19mm 1/8 H 424 lts/min
98008	Conveyvac aspiración 25mm 1/4 H 792 lts/min
98012	Conveyvac aspiración 38mm 1/4 H 792 lts/min
98022	Conveyvac aspiración 75mm 3/8 H 905 lts/min
98032	Conveyvac aspiración 100mm 1/2 H 1188 lts/min
98042	Conveyvac aspiración 150mm 1/2 H 1471 lts/min

90004	Conveyvac inox aspiración 19mm 1/8 H 424 lts/min
90008	Conveyvac inox aspiración 25mm 1/4 H 792 lts/min
90012	Conveyvac inox aspiración 38mm 1/4 H 792 lts/min
90022	Conveyvac inox aspiración 75mm 3/8 H 905 lts/min
90032	Conveyvac inox aspiración 100mm 1/2 H 1188 lts/min
90042	Conveyvac inox aspiración 25mm 1/2 H 1471 lts/min

98108	Convey. Strongman 25mm 1/4 H 1585 lts/min
98112	Convey. Strongman 38mm 1/4 H 1698 lts/min
98122	Convey. Strongman 75mm 3/8 H 2603 lts/min
98132	Convey. Strongman 100mm 1/2 H 3113 lts/min
98142	Convey. Strongman 150mm 1/2 H 3339 lts/min

90208	Convey. Inox Strongman 25mm 1/4 H 1585 lts/min
90212	Convey. Inox Strongman 38mm 1/4 H 1698 lts/min
90222	Convey. Inox Strongman 75mm 3/8 H 2603 lts/min
90232	Convey. Inox Strongman 100mm 1/2 H 3113 lts/min
90242	Convey. Inox Strongman 150mm 1/2 H 3339 lts/min

Modelos roscados a 25mm; 38mm y 150mm.	
90308	Convey. Inox Strongman 25mm 1/4 H 1585 lts/min
90312	Convey. Inox Strongman 38mm 1/4 H 1698 lts/min
90342	Convey. Inox Strongman 150mm 1/2 H 3339 lts/min



Tabla técnica, consumos y medidas (en mm)

Modelos	A	B	C	D	E	F	Consumos a 5,5bar	
							Consumo Std.	Strongman
9 -- 04	19	196,0	1/8	13,7	12,5	10,5	424 l/min	707 l/min
9 -- 08	25	87,5	1/4	20,0	25,0	37,5	792 l/min	1585 l/min
9 -- 12	38	142,5	1/4	31,2	37,5	68,7	792 l/min	1698 l/min
9 -- 22	75	150,0	3/8	56,2	37,5	100,0	905 l/min	2603 l/min
9 -- 32	101	200,0	1/2	81,2	50,0	125,0	1188 l/min	3113 l/min
9 -- 42	150	250,0	1/2	106,2	50,0	150,0	1471 l/min	3339 l/min



# ASPIRACIÓN Y TRANSPORTE DE SÓLIDOS AIRTX: Speedvac y Hoppervac

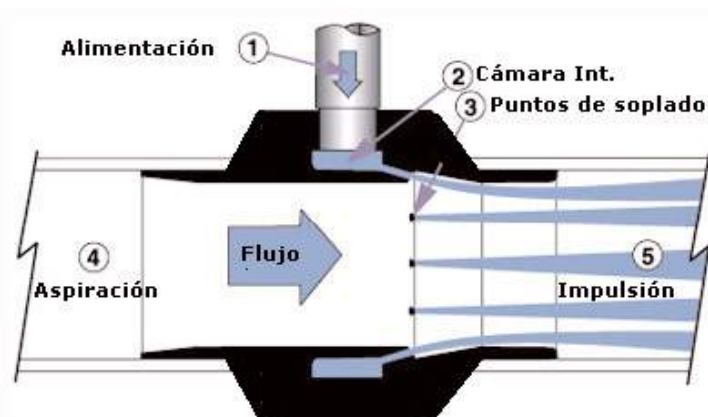
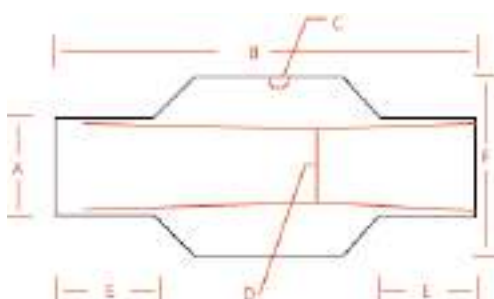

## AIRTX SPEEDVAC™ PISTOLA MANUAL DE ASPIRACIÓN

Vacío y pistola de soplado en una unidad !!! Ideales para recoger suciedad y partículas del lugar de trabajo. Antes que poner polvo y partículas en suspensión soplándolas, es mejor aspirar y mantener limpio el entorno laboral y productivo. Compactas, livianas, resistentes, de bajo coste..... La pistola de aspiración de AIRTX SpeedVac es la más eficiente de las herramientas de limpieza. Sin uso de un motor eléctrico, sin tener que vaciar un depósito engorroso de desmontar, sin partes adicionales. Sólo conectado a su red de aire comprimido y a cualquier punto de alimentación de su local/nave, puede aspirar virutas húmedas o partículas secas y depositarlas directamente dentro de un contenedor abierto o bien derivarlas al sistema de aspiración centralizado de la empresa.

Se puede pasar de función Aspirado a función Soplado sólo con revertir la cámara interna. Presión max.: 8 bar Cap. vacío: 2,5 Hg a 5,5 bar Diám.boca: 25mm (Int) 30mm (Ext) Consumo a 5,5 bar: 509 lts/min Caudal efectivo a 5,5 bar: 5200 lts/min Nivel sonoro: 80 dBA



- [90400](#) Speedvac Pistola aspiración + kit
- [90401](#) Speedvac Pistola aspiración sola
- [90420](#) Holvevac Pistola aspiración P/fondos-agujeros
- [90410](#) Bolsa reutilizable portátil
- [90412](#) Tapa textil p/bidones de 20 lts
- [90402](#) Manguera 1"1/4 de 3 mts 2 x 1" conectores
- [90403](#) Tubo prolongador 28cmts
- [90404](#) Cepillo recogedor
- [90405](#) Espátula rectangular cortada en diagonal
- [90407](#) Recogedor rectangular
- [95308](#) HOPPERVAC Kit trasvase material



## 95308 HOPPERVAC Kit trasvase material

HOPPERVAC™ 95308 Trasvase de material para máquinas de inyección de plástico. Hoppervac (Kit aspiración de sólidos) : con amplificador, mangueras, válvula y tubo de aluminio. Pensado para insertar dentro de sacos o contenedores para transportar granúlos plásticos (u otros materiales) hacia la tobera principal de alimentación de la máquina. Fácil funcionamiento, sin peligro, capacidad hasta 22 Kg/minuto (1320 Kg/hora).

AIRTX ha diseñado este producto para simplificar el montaje y la funcionalidad al máximo. El amplificador unido a un robusto sistema de alimentación-impulsión finalizado con un abarcón de seguridad hace que pueda usarse en las condiciones habituales de dureza en la producción. Dotado de una manguera que acaba con un racor en "U" para colocar en la Tobera de la máquina de inyección. El amplificador "Hurricane" es el mejor del mercado, diseñado y tarado para aumentar en poder de succión considerablemente con respecto a los demás sistemas de aspiración. El Hoppervac no tiene partes móviles y sólo funciona con aire comprimido (cada vez más usado en la industria), el producto seco pasa limpiamente a través de él con suma rapidez. Además no hay riesgo de explosión por concentración de gases, ya que en todo momento hay contacto atmosférico entre la toma de aspiración y el final de eyección.

### INSTRUCCIONES DE FUNCIONAMIENTO:

Ajuste el conector macho al enchufe rápido (en dotación). Con la válvula en posición cerrado (Perpendicular) conecte la línea de aire comprimido ". Ensamble la manguera y póngala el final "U" al lugar donde procederá al desalojo de los elementos granúlos de plástico. En el momento que abra la válvula y dé presión al Hoppervac (a 5,5 bar) ya puede empezar a trasvasar granúlos. Efectuar una limpieza tanto exterior e interior del Hoppervac cada cierto tiempo. Asegurarse también que ningún residuo quede enganchado en ninguna parte del recorrido de aspiración, puesto que entorpecería el paso y bajaría el rendimiento de la máquina. Instalar un prefiltro de 5 micras en la alimentación de aire.

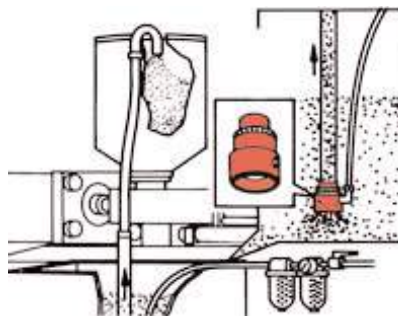

### CARACTERÍSTICAS TÉCNICAS

Rango de presión operativo: 5,5 bar  
 Nivel de ruido: 72 dBA  
 Diametro de paso: 19,5mm  
 Consumo de aire: 255 lts/min a 5,5 bar  
 Ratio de amplificación: 12:1  
 Diámetro de manguera: 1 1/2"  
 Longitud de manguera: 3 mts  
 Desplazamiento granza: 22 Kg/min



## ASPIRACIÓN DE SÓLIDOS AIRTX SMARTVAC - Aspirador Industrial potente, seguro y funcional.



### 90755: SMARTVAC KIT - 99755: STRONGMAN SMARTVAC KIT ASPIRACIÓN DE SÓLIDOS / HÚMEDOS SIN ELECTRICIDAD

Resistentes a la corrosión. Sin uso de motores. Sin electricidad, sin partes móviles. Portátiles. Silenciosos. Smartvac ideal para recogida de residuos secos y/o húmedos para sierras, tornos, CNC's, esmeriles, moldes, fresadoras... etc. Recogida y almacenaje efectivo de viruta desde el suelo, la maquinaria o el lugar del trabajo.

¿Porqué Smartvac? - Porqué Smartvac está pensado específicamente para este uso. El robusto amplificador inoxidable crea una acción ciclónica de aire dentro del bidón, que es desplazado hacia el exterior a través de la abertura en la tapa superior (la bolsa textil evita que salga la suciedad acumulada), que aumenta en poder de succión considerablemente con respecto a los demás sistemas de aspiración.

El Smartvac no tiene partes móviles y sólo funciona con aire comprimido (cada vez más usado en la industria), el producto seco o húmedo pasa limpiamente a través de él y es almacenado en el bidón con suma rapidez. Además no hay riesgo de explosión por concentración de gases, ya que en todo momento hay contacto atmosférico entre la toma de aspiración y la tapa del bidón.

Todos los aspiradores operados eléctricamente no son adecuados para uso industrial. Las virutas o los aceites corrosivos llegan a destruir los motores y hay riesgos de rotura e incluso explosión. Con el Smartvac desaparecen esos riesgos y además fomenta el reciclaje, dos puntos clave en las exigencias de las normativas actuales en seguridad y medio ambiente.

El Smartvac kit 90755 ó Strongman Smartvac 99755 (con un 50% más de poder succionador) contienen el Generador de vacío, 25 cm de tubo de acero de una pulgada y media, válvula de apertura-cierre con manómetro, recogedor, mangueras, espátula, cepillo redondo, tapa del bidón con tórica de goma, bolsa-filtro y soporte de acero con ruedas para mejor movilidad del bidón.



#### FAMILIA SMARTVAC

<a href="#">90755</a>	SMARTVAC KIT
<a href="#">90755-1</a>	SMARTVAC Solo
<a href="#">90756</a>	SMARTVAC KIT Excepto soporte rodante
<a href="#">99755</a>	Strongman SMARTVAC KIT
<a href="#">99755-1</a>	Strongman SMARTVAC Solo
<a href="#">99756</a>	Strongman Smartvac KIT Excepto soporte rod.
<a href="#">90751</a>	SmartVac Filtros de aire - Bolsa de 3 uds.
<a href="#">90720</a>	Soporte acero con ruedas p/bidones de 200 lts
<a href="#">90500-14</a>	Manguera de 3 mts 2 x 1 1/2 conectores



#### Puesta en marcha del SMARTVAC

- Ajuste la válvula de cierre y el manómetro de presión ensambladas con un tubo de ¼" y rósquelas en la entrada de ¼ hembra del Smartvac
  - Rosque el Smartvac en la abertura de ¾" de la tapa con bolsa que viene en dotación.
  - Ponga la tapa en la parte superior de un bidón convencional de 200 lts, ajústela bien y asegúrela con la tuerca del aro/abrazadera de la tapa.
  - Con la válvula en posición cerrado (Perpendicular) conecte la línea de aire comprimido de ¼".
  - Ensamble manguera y los elementos de limpieza/recogida que desee en la toma superior del Smartvac.
  - El soporte con ruedas es de uso opcional, convierte al conjunto Smartvac en portable.
  - Instalar un prefiltro de 5 micras en la alimentación de aire. En el momento que abra la válvula y dé presión al Smartvac ( 5,5 bar) ya puede empezar a recoger residuos. Efectuar una limpieza tanto exterior e interior del Smartvac cada cierto tiempo. Asegúrase también que ningún residuo quede enganchado en ninguna parte del recorrido de aspiración, puesto que entorpecería el paso y bajaría el rendimiento de la máquina.:
- Importante: Conectores con pasos de aire pequeños restringen el caudal y podrían no obtenerse los resultados esperados.

#### CARACTERÍSTICAS TÉCNICAS

SmartVac™ 90755

Rango de presión operativo: 5,5 bar a 8,3 bar

Nivel de ruido: 80 dBA

Capacidad de vacío: 4.0 HG a 5,5bar

Diámetro de paso: 1 ¼"

Consumo de aire: 849 lts/min a 5,5 bar

StrongMan SmartVac™ 99755

Rango de presión operativo: 5,5 bar a 8,3 bar

Nivel de ruido: 80 dBA

Capacidad de vacío: 8.0 HG a 5,5bar

Diámetro de paso: 1 ¼"

Consumo de aire: 1415 lts/min a 5,5 bar



# ASPIRACIÓN LÍQUIDOS AIRTX - DRUM DEVIL



## DRUM DEVIL KIT Modelo 90600 Y DRUM DEVIL II KIT Modelo 90650 ASPIRACIÓN DE LÍQUIDOS POR VACÍO

Dispositivos para recogida y trasvase rápida de lubricantes y fluidos. Llenado de barriles comunes de 200 lts, en aprox. 90 segundos. Resistente a la corrosión. Inoxidable. Sin uso de motores. Sin electricidad, sin partes móviles. Portátiles. Silenciosos.

Drum Devil ideal para la recogida de fluidos y residuos húmedos para talleres, mantenimientos hidráulicos, sierras, tornos, CNC's, esmeriles, mol-des, fresadoras... etc. Recogida y almacenaje efectivo de aceite y taladrina desde el suelo, la maquinaria o el lugar del trabajo.

Con la misma filosofía Smartvac pero con la tapa cerrada, los Drum Devil I y II crean un vacío dentro del barril de acero cuando está en posición de llenado (Fill) permitiendo al operador llenar un barril de 200 lt. en 90 segundos, a 5,5 bar de presión y un consumo de aire de 792 lts/min.

El Drum Devil no tiene partes móviles y sólo funciona con aire comprimido (cada vez más usado en la industria), el fluido con viruta pasa limpiamente a través de la manguera de succión y es almacenado en el bidón con suma rapidez. Además, el riesgo de explosión por concentración de gases baja considerablemente al no estar alimentado eléctricamente.



### Gama de productos DRUM DEVIL

<a href="#">90600</a>	DRUM DEVIL I KIT (Solo llenado)
<a href="#">90601</a>	DRUM DEVIL I (Sólo aspirador)
<a href="#">90650</a>	DRUM DEVIL II KIT (Llenado y vaciado)
<a href="#">90651</a>	DRUM DEVIL II (Sólo aspirador)
Complementos:	
<a href="#">90720</a>	Soporte acero rodante p/bidones 200lts
<a href="#">90500-13</a>	Recogedor plano con ribete de goma
<a href="#">90500-14</a>	Manguera 3 mts 2 x 1"1/2 conectores
<a href="#">90500-15</a>	Tubo blanco p/vaciar Bidón
<a href="#">90500-16</a>	Conector 2"Rosca Macho para bidón
<a href="#">90500-17</a>	Racor de conexión codo p/conector bidón
<a href="#">90404</a>	Alargo para recogedor.
<a href="#">90405</a>	Espátula rectangular cortada en diagonal
<a href="#">90407</a>	Recogedor rectangular



Los DRUM DEVIL (Kit) vienen dotados de todos los elementos necesarios para el uso en planta o lugar de trabajo. Las espátulas y accesorios tienen la función de aspirar y recoger fluidos no sólo de tanques sino también directamente del suelo.

Usado comúnmente para taladrinas, aceites (y grasas según densidad), puede plantearse como aspirador de otros fluidos con diferentes viscosidades, pero siempre bajo cuenta y riesgo del cliente usuario final. Asimismo, el modelo Drum Devil II crea una presión de 0,6 bar dentro del tanque en modo "vaciar" (empty), permitiendo al operador vaciar el barril de 200 lts también en 90 segundos.

### Puesta en marcha del DRUM DEVIL I y II

- Adjunte la válvula de cierre y el manómetro de presión ensambladas con un tubo de 1/4" y rósquelas en la entrada de 1/4 hembra del Drum Devil
- Rósque el Drum Devil en la abertura de 3/4" del bidón.
- Atornille el conector de 2" en la abertura de 2" del bidón de acero, al otro lado. Tire de las anillas hasta que quede bien sujeto el conector.
- Con la válvula en posición cerrado (Perpendicular) conecte la línea de aire comprimido de 1/4".

### LLENAR EL BARRIL CON EL MODO DE VACÍO DEL DRUM DEVIL II:

- El mando negro situado encima del cuerpo del D.DII tiene que estar cerrado en el sentido de las agujas del reloj.
- Conecte en la abertura de 2" los utensilios que precise para la operación de llenado de fluidos.
- Abra la válvula lentamente hasta el tope. El D.DII hará el vacío dentro del tanque y la parte superior del bidón será presionada ligeramente.
- Inserte la punta elegida en el líquido a recoger. Presionando en sacudidas lentas es efectivo para recoger el líquido derramado. Una vez el líquido tapone los pasos de aire del DDII, dejará de aspirar, siendo éste un sistema automático antiderramamiento.

### VACIANDO EL BIDÓN USANDO EL DDII CON EL MODO PRESIÓN.

- Monte el tubo de PVC de 90 cm. Dentro del bidón a través de la manguera de 2" de aspiración. Vuelva a ajustar el conector otra vez tirando de las anillas.
- Con el aire comprimido cerrado, abra el mando negro situado encima del DDII. No es necesario llegar hasta el final.
- Ponga la punta en un container adecuado para la operación de trasvase.
- Abra la válvula de aire lentamente hasta el tope.
- Vuelva a cerrar la válvula cuando el bidón se haya vaciado.



### CARACTERÍSTICAS TÉCNICAS

Drum Devil™ 90600 y Drum Devil II™ 90650  
 Rango de presión operativo: 5,5 bar a 8,3 bar  
 Nivel de ruido: 78 dBA  
 Capacidad de vacío: 8,5 HG a 5,5bar  
 Diametro de paso: 1 1/2"  
 Consumo de aire: 792 lts/min a 5,5 bar



### RACORES CDC Instantáneos de plástico:

Combinados latón cromado/resina termoplástica. Rosca cónica teflonada y cilíndrica con tórica. Pulsador circular, pinza multiagarre de acero inoxidable Aisi 316. Collarín de estanqueidad interior. Presión de servicio 10 bar. Vacío 750 mmHg. -5 a +70°C. Roscas M5 paso 0,8 y M6 paso 1,0. Óptimos para tubo de poliuretano de 98 sh y PA12. Resistentes al agua, grasas y aceites.

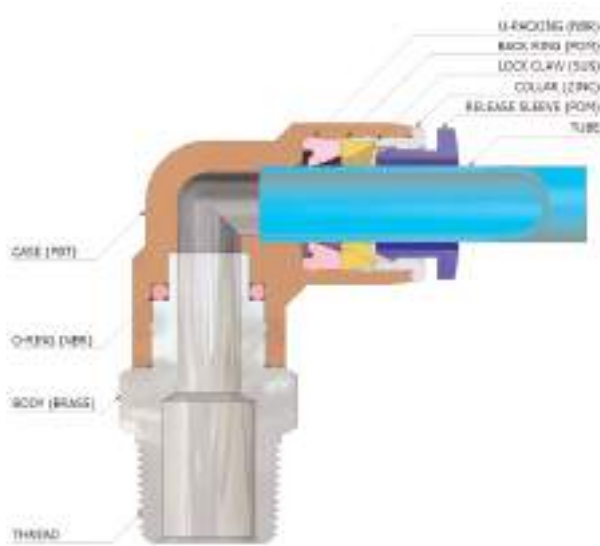

### CDC Fitting : Features (English)

Quality pneumatic and fluid fittings presented by CDC PNEUMATICS, manufacturer since 1983, one of the bests and most popular worldwide leading supplier. One-Touch push-to-connect configuration allows an instant tubing connection. Smooth-Edge release sleeve facilitates a quick tubing disconnection. Aesthetically pleasing nickel-plated metallic optional feature ensures anti-contamination properties for an extended product life. Pre-applied sealant on all external threads eliminates additional sealing requirement. Internal and/or external flat-to-flat hexagonal configurations for both metric and inch. Specifications allow a proper tightening or directional orientation upon installation by using L key or allen wrench for the applicable model types. Applicable Fluid Type AIR (No other type of gas or liquid) Working Pressure Range 0~150PSI 0~9.9Kgf/cm<sup>2</sup>(0~990KPa) Negative Pressure -29.5in Hg -750mmHg(-750Torr) Working Temperature Range 32~140°F 0~70°C

### TOLERANCIAS DEL DIÁMETRO EXT. TUBERIAS:

D3: +0,10	D8: +0,10	D14: +0,15
D4: +0,10	D10: +0,15	D16: +0,15
D6: +0,10	D12: +0,15	

### LONGITUD DE TUBO INSERTADO EN RACOR (mm):

Compact	Standard:	
D3: 11,3	D4: 15,0	D10: 20,1
D4: 11,8	D6: 16,5	D12/14: 22,9
D6: 12,9	D8: 18,8	D16: 23,6



Recommended Connection Torque (by thread)		
Thread type	Thread Size	Recommended torque
Metric Thread (mm)	M3 x P0,5	0,7 Nm
	M5 x P0,8	1,5 Nm
	M6 x P1,0	2,3 Nm
Pipe Taper Thread (PT)	R1/8	7 Nm
	R3/8	22 Nm
	R1/2	28 Nm
Unified Thread (UN)	No. 10-32 UNF	1,5 Nm
	NPT1/16	7 Nm
NPT Thread	NPT1/8	7 Nm
	NPT1/4	12 Nm
	NPT3/8	22 Nm
	NPT1/2	28 Nm
PT/24	G 1/8	10 Nm
	G 1/4	15 Nm
	G 3/8	25 Nm
	G 1/2	40 Nm

### PAR DE APRIETE ROSCAS (Kgf-cm):

M3 x P0,5 - 0,7 N.m
M5 x P0,8 - 1,5 N.m
M6 x P1,0 - 2,3 N.m

Cónica R1/8 - 7 N.m
Cónica R1/4 - 12 N.m
Cónica R3/8 - 22 N.m
Cónica R1/2 - 28 N.m

Cilíndricas:
G1/8 - 10 N.m
G1/4 - 15 N.m
G3/8 - 25 N.m
G1/2 - 40 N.m



We Preserve The Best Quality and Technique Advancement Policy with The Name of CDCPNEUMATICS



**PC: Racor Instantáneo Recto Cónico**

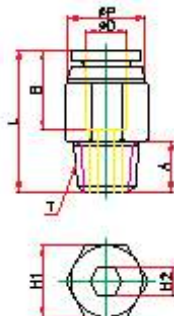

MODELO	D	P	T	L	A	B	H1	H2	Orificio	PESO
PC04-M5	4	10.0	M5*0.8	21.9	4.6	15.9	10	-	2.5	5.8
PC04-M6	4	10.0	M6*1.0	21.9	4.1	15.9	10	-	3.0	5.8
PC04-01	4	10.0	R 1/8	21.6	8.0	15.9	10	3	3.0	7.8
PC04-02	4	10.0	R 1/4	20.6	10.0	15.9	14	3	3.0	14.8
PC04-03	4	10.0	R 3/8	22.0	11.0	15.9	17	3	3.0	26.8
PC06-M5	6	12.0	M5*0.8	23.6	4.6	16.5	12	-	2.5	8.8
PC06-M6	6	12.0	M6*1.0	23.1	4.1	16.5	12	-	3.0	8.8
PC06-01	6	12.0	R 1/8	22.2	8.0	16.5	12	4	4.0	8.8
PC06-02	6	12.0	R 1/4	21.0	10.0	16.5	14	5	5.0	12.8
PC06-03	6	12.0	R 3/8	22.0	11.0	16.5	17	5	5.0	25.8
PC06-04	6	12.0	R 1/2	29.3	14.0	16.5	19	5	5.0	49.8
PC08-01	8	14.0	R 1/8	27.5	8.0	17.7	14	5	5.0	14.7
PC08-02	8	14.0	R 1/4	25.5	10.0	17.7	14	6	6.0	18.7
PC08-03	8	14.0	R 3/8	23.0	11.0	17.7	17	6	6.0	21.7
PC08-04	8	14.0	R 1/2	29.7	14.0	17.7	19	6	6.0	49.7
PC10-01	10	16.1	R 1/8	28.7	8.0	18.6	17	5	5.0	21.5
PC10-02	10	16.1	R 1/4	30.7	10.0	18.6	17	6	6.0	24.5
PC10-03	10	16.1	R 3/8	24.7	11.0	18.6	17	8	8.0	41.5
PC10-04	10	16.1	R 1/2	29.7	14.0	18.6	19	8	8.0	51.5
PC12-01	12	19.0	R 1/8	32.3	8.0	20.9	19	5	5.0	28.3
PC12-02	12	19.0	R 1/4	32.8	10.0	20.9	19	6	6.0	36.3
PC12-03	12	19.0	R 3/8	29.8	11.0	20.9	19	8	8.0	30.3
PC12-04	12	19.0	R 1/2	29.8	14.0	20.9	19	8	8.0	48.3
PC14-03	14	21.8	R 3/8	36.6	11.0	23.8	22	10	10.0	42.0
PC14-04	14	21.8	R 1/2	40.0	14.0	23.8	22	10	10.0	49.0
PC16-03	16	24.0	R 3/8	37.3	11.0	24.8	24	10	10.0	50.0
PC16-04	16	24.0	R 1/2	40.3	14.0	24.8	24	10	10.0	63.0

**PC-G: Racor Instantáneo Recto Cilíndrico**

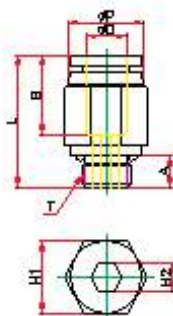

MODELO	D	P	T	L	A	B	H1	H2	Orificio	PESO
PC04-G01	4	10.3	G1/8	21.5	5.0	15.9	13	3	3.0	10.8
PC04-G02	4	10.3	G1/4	23.5	6.5	15.9	15	3	3.0	18.8
PC04-G03	4	10.3	G3/8	23.5	6.5	15.9	17	3	3.0	21.8
PC06-G01	6	12.3	G1/8	22.5	5.0	16.5	13	4	4.0	9.8
PC06-G02	6	12.3	G1/4	24.5	6.5	16.5	15	5	5.0	16.8
PC06-G03	6	12.3	G3/8	25.5	6.5	16.5	17	5	5.0	23.8
PC08-G01	8	14.3	G1/8	26.7	5.0	17.7	15	5	5.0	16.7
PC08-G02	8	14.3	G1/4	26.7	6.5	17.7	15	6	6.0	14.7
PC08-G03	8	14.3	G3/8	25.0	6.5	17.7	17	6	6.0	22.7
PC08-G04	8	14.3	G1/2	26.0	8.0	17.7	21	6	6.0	39.7
PC10-G01	10	16.5	G1/8	29.5	5.0	18.6	17	5	5.0	21.5
PC10-G02	10	16.5	G1/4	30.0	6.5	18.6	17	6	6.0	22.5
PC10-G03	10	16.5	G3/8	27.0	6.5	18.6	17	8	8.0	21.5
PC10-G04	10	16.5	G1/2	28.3	8.0	18.6	21	8	8.0	36.5
PC12-G02	12	19.0	G1/4	32.2	6.5	20.9	19	6	6.0	26.3
PC12-G03	12	19.0	G3/8	31.6	6.5	20.9	19	8	8.0	22.3
PC12-G04	12	19.0	G1/2	31.6	8.0	20.9	21	8	8.0	36.5
PC14-G03	14	21.8	G3/8	33.5	6.5	23.8	22	10	10.0	48.0
PC14-G04	14	21.8	G1/2	32.8	8.0	23.8	24	10	10.0	57.0
PC16-G03	16	24.0	G3/8	36.3	6.5	24.8	24	10	10.0	53.0
PC16-G04	16	24.0	G1/2	36.3	8.0	24.8	24	10	10.0	59.0

**PCF: Racor Instantáneo Recto Hembra Cónico**

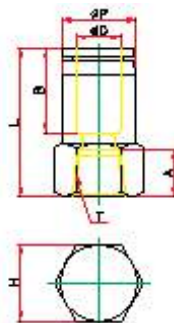

MODELO	D	P	T	L	A	B	H1	Orificio	PESO
PCF04-M5	4	10.0	M5*0.8p	25.6	7.0	15.9	12	3.5	8.8
PCF04-01	4	10.0	R1/8	26.7	8.0	15.9	14	3.5	15.8
PCF04-02	4	10.0	R1/4	28.7	10.0	15.9	17	3.5	19.8
PCF04-03	4	10.0	R3/8	29.7	11.0	15.9	22	3.5	33.8
PCF06-M5	6	12.0	M5*0.8p	25.8	7.0	16.5	12	4.2	10.8
PCF06-01	6	12.0	R1/8	27.3	8.0	16.5	14	5.0	17.8
PCF06-02	6	12.0	R1/4	29.3	10.0	16.5	17	5.0	23.8
PCF06-03	6	12.0	R3/8	30.2	11.0	16.5	22	5.0	35.8
PCF06-04	6	12.0	R1/2	32.2	14.0	16.5	24	5.0	39.8
PCF08-01	8	14.0	R1/8	28.5	8.0	17.7	14	6.0	18.7
PCF08-02	8	14.0	R1/4	30.5	10.0	17.7	17	6.0	25.7
PCF08-03	8	14.0	R3/8	31.5	11.0	17.7	22	6.0	38.7
PCF08-04	8	14.0	R1/2	33.5	14.0	17.7	24	6.0	45.7
PCF10-01	10	16.4	R1/8	31.4	8.0	18.6	17	8.5	31.5
PCF10-02	10	16.4	R1/4	31.5	10.0	18.6	17	8.5	26.5
PCF10-03	10	16.4	R3/8	32.4	11.0	18.6	22	8.5	39.5
PCF10-04	10	16.4	R1/2	34.4	14.0	18.6	24	8.5	40.5
PCF12-02	12	18.6	R1/4	34.7	10.0	20.9	22	10.0	53.3
PCF12-03	12	18.6	R3/8	34.7	11.0	20.9	22	10.0	43.3
PCF12-04	12	18.6	R1/2	36.7	14.0	20.9	24	10.0	49.3

**PCF-G: Racor Instantáneo Recto Hembra Cilíndrico**

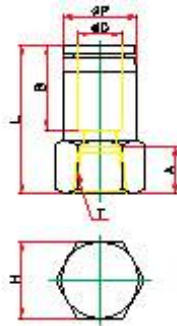

MODELO	D	P	T	L	A	B	H1	Orificio	PESO
PCF04-G01	4	10.0	G 1/8	28.6	8.0	15.9	14	3.0	14.8
PCF04-G02	4	10.0	G 1/4	29.6	10.0	15.9	17	3.0	19.8
PCF04-G03	4	10.0	G 3/8	30.6	11.0	15.9	22	3.5	32.8
PCF06-G01	6	12.0	G 1/8	30.0	8.0	16.5	14	5.0	15.8
PCF06-G02	6	12.0	G 1/4	31.0	10.0	16.5	17	5.0	21.8
PCF06-G03	6	12.0	G 3/8	32.0	11.0	16.5	22	5.0	34.8
PCF08-G01	8	14.0	G 1/8	31.0	8.0	17.7	14	6.0	17.7
PCF08-G02	8	14.0	G 1/4	32.0	10.0	17.7	17	6.0	23.7
PCF08-G03	8	14.0	G 3/8	33.0	11.0	17.7	22	6.0	36.7
PCF08-G04	8	14.0	G 1/2	35.0	14.0	17.7	24	6.0	36.7
PCF10-G01	10	16.4	G 1/8	31.7	8.0	18.6	17	8.0	30.5
PCF10-G02	10	16.4	G 1/4	32.7	10.0	18.6	17	8.0	25.5
PCF10-G03	10	16.4	G 3/8	33.7	11.0	18.6	22	8.0	39.5
PCF10-G04	10	16.4	G 1/2	35.7	14.0	18.6	24	8.0	39.5
PCF12-G02	12	18.6	G 1/4	36.4	10.0	20.9	22	10.0	52.3
PCF12-G03	12	18.6	G 3/8	36.4	11.0	20.9	22	10.0	44.3
PCF12-G04	12	18.6	G 1/2	38.4	14.0	20.9	24	10.0	44.3

**POC: Racor Instantáneo Recto Circular cónico**

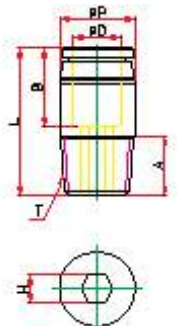

MODELO	D	P	T	L	A	B	H1	Orificio	PESO
POC04-M5	4	10.0	M5*0.8p	21.8	4.6	15.9	2	2.0	5.8
POC04-M6	4	10.0	M6*1.0p	21.8	4.6	15.9	3	3.0	5.8
POC04-01	4	10.0	R 1/8	20.4	8.0	15.9	3	3.0	7.8
POC04-02	4	14.0	R 1/4	20.4	10.0	15.9	3	3.0	13.8
POC04-03	4	17.0	R 3/8	20.4	11.0	15.9	3	3.0	23.8
POC06-M5	6	12.0	M5*0.8p	22.6	4.6	16.5	2	2.0	7.8
POC06-M6	6	12.0	M6*1.0p	24.1	4.6	16.5	3	3.0	7.8
POC06-01	6	12.0	R 1/8	21.8	8.0	16.5	4	4.0	14.8
POC06-02	6	14.0	R 1/4	22.5	10.0	16.5	4	4.0	24.8
POC06-03	6	17.0	R 3/8	22.5	11.0	16.5	4	4.0	24.8
POC08-01	8	14.0	R 1/8	27.0	8.0	17.7	5	5.0	11.7
POC08-02	8	14.0	R 1/4	25.0	10.0	17.7	6	6.0	14.7
POC08-03	8	17.0	R 3/8	25.0	11.0	17.7	6	6.0	24.7
POC08-04	8	21.0	R 1/2	25.0	14.0	17.7	6	6.0	45.7
POC10-01	10	17.0	R 1/8	27.9	8.0	18.6	5	5.0	15.5
POC10-02	10	17.0	R 1/4	26.6	10.0	18.6	6	6.0	16.5
POC10-03	10	17.0	R 3/8	26.6	11.0	18.6	8	8.0	22.5
POC10-04	10	21.0	R 1/2	26.6	14.0	18.6	8	8.0	39.5
POC12-01	12	19.0	R 1/8	32.4	8.0	20.9	5	5.0	23.3
POC12-02	12	19.0	R 1/4	32.4	10.0	20.9	6	6.0	25.3
POC12-03	12	19.0	R 3/8	32.4	11.0	20.9	8	8.0	31.3
POC12-04	12	21.0	R 1/2	32.4	14.0	20.9	8	8.0	38.3

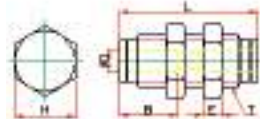

**PMP : Racor Instantáneo Pasamuros Recto Plástico**  
**PMM : Racor Instantáneo Pasamuros Recto**

MODELO	D	T	L	E	B	H(Hex)	Orificio	PESO
PMP04	4	M12*1.2p	32.0	6.0	14.8	13	3.0	5.4
PMP06	6	M14*1.5p	36.0	6.5	16.4	15	5.0	7.8
PMP08	8	M16*1.5p	38.8	7.0	18.3	17	7.0	10.8
PMP10	10	M20*1.7p	44.1	8.0	20.2	21	8.0	16.8
PMP12	12	M22*1.7p	47.6	8.5	22.9	24	10.0	24.5
PMM04	4	M12*1.0p	35.5	4	16.3	14	3.0	19.6
PMM06	6	M14*1.0p	39.9	4	17.6	17	5.0	28.6
PMM08	8	M16*1.0p	42.2	5	18.7	19	7.0	36.4
PMM10	10	M20*1.0p	45.0	5	19.6	24	9.0	65.0
PMM12	12	M22*1.0p	50.3	5	21.9	26	11.0	83.1
PMM16	16	M27*1.0p	53.1	6	24.0	32	12.0	135.0

**PMF-G: Racor Instantáneo Pasamuros Recto Hembra Cilíndrico**

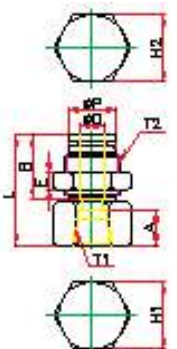

MODELO	D	P	T	L	E	A	B	H1	H2	Orificio	PESO
PMF04-G01	4	10.0	R 1/8	26.7	4	8.0	16.8	14	14	3.0	19.8
PMF04-G02	4	10.0	R 1/4	28.7	4	10.0	16.8	17	14	3.0	24.8
PMF04-G03	4	10.0	R 3/8	29.7	4	11.0	16.8	22	14	3.0	37.8
PMF06-G01	6	12.0	R 1/8	28.3	4	8.0	17.6	17	17	5.0	33.8
PMF06-G02	6	12.0	R 1/4	30.3	4	10.0	17.6	17	17	5.0	27.8
PMF06-G03	6	12.0	R 3/8	31.3	4	11.0	17.6	22	17	5.0	42.8
PMF08-G01	8	14.0	R 1/8	29.5	5	8.0	18.7	19	19	6.0	43.7
PMF08-G02	8	14.0	R 1/4	31.5	5	10.0	18.7	19	19	6.0	38.7
PMF08-G03	8	14.0	R 3/8	32.5	5	11.0	18.7	22	19	6.0	44.7
PMF08-G04	8	14.0	R 1/2	34.5	5	14.0	18.7	24	19	6.0	45.7
PMF10-G01	10	16.1	R 1/8	30.4	5	8.0	19.6	24	24	8.0	76.5
PMF10-G02	10	16.1	R 1/4	32.4	5	10.0	19.6	24	24	8.0	70.5
PMF10-G03	10	16.1	R 3/8	33.4	5	11.0	19.6	24	24	8.0	63.5
PMF10-G04	10	16.1	R 1/2	36.2	5	14.0	19.6	24	24	8.0	54.5
PMF12-G02	12	19.0	R 1/4	37.9	5	10.0	21.9	24	26	10.0	81.3
PMF12-G03	12	19.0	R 3/8	37.9	5	11.0	21.9	24	26	10.0	72.3
PMF12-G04	12	19.0	R 1/2	39.9	5	14.0	21.9	24	26	10.0	65.3

**PL: Racor Instantáneo Codo Orientable Cónico**

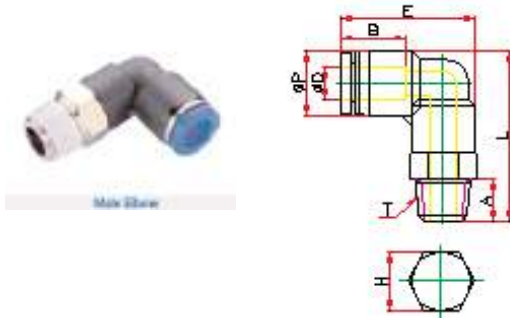

MODELO	D	P	T	L	E	A	B	H1	Orificio	PESO
PL04-M5	4	10.5	M5*1.0p	25.8	23.8	4.1	16.8	10	2.5	7.8
PL04-M6	4	10.5	M6*1.0p	25.8	23.8	4.1	16.8	10	2.5	7.8
PL04-01	4	10.5	R 1/8	29.8	23.8	8.0	16.8	10	3.0	10.8
PL04-02	4	10.5	R 1/4	31.8	23.8	10.0	16.8	14	3.0	17.8
PL04-03	4	10.5	R 3/8	32.8	23.8	11.0	16.8	17	3.0	31.8
PL06-M5	6	12.5	M5*0.8p	30.3	26.5	4.6	17.6	12	2.5	5.7
PL06-M6	6	12.5	M6*1.0p	28.9	26.5	4.1	17.6	12	3.0	5.7
PL06-01	6	12.5	R 1/8	32.8	26.5	8.0	17.6	12	4.5	14.7
PL06-02	6	12.5	R 1/4	35.8	26.5	10.0	17.6	14	4.5	19.7
PL06-03	6	12.5	R 3/8	36.8	26.5	11.0	17.6	17	4.5	26.7
PL06-04	6	12.5	R 1/2	39.8	26.5	14.0	17.6	21	4.5	46.7
PL08-01	8	14.8	R 1/8	35.2	29.7	8.0	18.7	14	6.0	17.7
PL08-02	8	14.8	R 1/4	38.2	29.7	10.0	18.7	14	6.0	22.7
PL08-03	8	14.8	R 3/8	39.2	29.7	11.0	18.7	17	6.0	29.7
PL08-04	8	14.8	R 1/2	42.2	29.7	14.0	18.7	21	6.5	49.7
PL10-01	10	17.5	R 1/8	37.3	32.1	8.0	19.6	17	6.0	24.2
PL10-02	10	17.5	R 1/4	40.3	32.1	10.0	19.6	17	7.0	30.2
PL10-03	10	17.5	R 3/8	41.3	32.1	11.0	19.6	17	7.0	33.2
PL10-04	10	17.5	R 1/2	44.3	32.1	14.0	19.6	21	7.0	53.2
PL12-01	12	20.5	R 1/8	42.7	36.9	8.0	21.9	19	6.0	39.1
PL12-02	12	20.5	R 1/4	44.7	36.9	10.0	21.9	19	7.0	42.1
PL12-03	12	20.5	R 3/8	45.7	36.9	11.0	21.9	19	10.0	41.1
PL12-04	12	20.5	R 1/2	48.7	36.9	14.0	21.9	21	10.0	53.1
PL14-03	14	22.5	R 3/8	55.6	44.1	11.0	24.0	24	10.0	67.0
PL14-04	14	22.5	R 1/2	58.3	44.1	14.0	24.0	24	13.0	76.0
PL16-03	16	25.5	R 3/8	55.6	44.1	11.0	24.0	24	10.0	67.0
PL16-04	16	25.5	R 1/2	58.3	44.1	14.0	24.0	24	13.0	76.0

**PL-G: Racor Instantáneo Codo Cilíndrico**

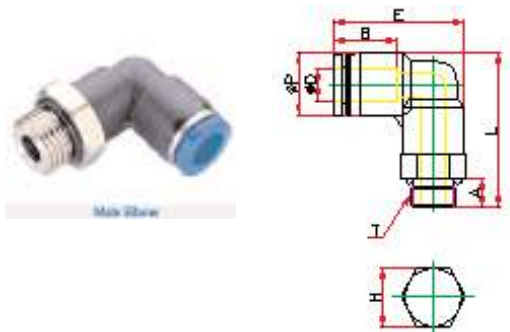

MODELO	D	P	T	L	E	A	B	H	Orificio	PESO
PL04-G01	4	10.5	G 1/8	27.4	23.8	5.0	16.8	14	3.0	12.8
PL04-G02	4	10.5	G 1/4	29.4	23.8	6.5	16.8	17	3.0	15.8
PL04-G03	4	10.5	G 3/8	30.4	23.8	6.5	16.8	20	3.0	21.8
PL06-G01	6	12.5	G 1/8	30.6	26.5	5.0	17.6	14	4.0	13.7
PL06-G02	6	12.5	G 1/4	32.6	26.5	6.5	17.6	17	4.0	19.7
PL06-G03	6	12.5	G 3/8	33.6	26.5	6.5	17.6	20	4.0	23.7
PL08-G01	8	14.5	G 1/8	32.9	29.7	5.0	18.7	14	6.0	14.7
PL08-G02	8	14.5	G 1/4	34.9	29.7	6.5	18.7	17	6.0	21.7
PL08-G03	8	14.5	G 3/8	35.9	29.7	6.5	18.7	20	6.0	26.7
PL08-G04	8	14.5	G 1/2	36.9	29.7	8.0	18.7	24	6.0	36.7
PL10-G01	10	17.5	G 1/8	35.4	32.1	5.0	19.6	17	7.0	23.2
PL10-G02	10	17.5	G 1/4	37.4	32.1	6.5	19.6	17	7.0	22.2
PL10-G03	10	17.5	G 3/8	38.4	32.1	6.5	19.6	20	7.0	29.2
PL10-G04	10	17.5	G 1/2	39.4	32.1	8.0	19.6	24	7.0	41.2
PL12-G02	12	20.5	G 1/4	41.4	36.9	6.5	21.9	19	8.0	33.1
PL12-G03	12	20.5	G 3/8	42.4	36.9	6.5	21.9	20	10.0	34.1
PL12-G04	12	20.5	G 1/2	43.4	36.9	8.0	21.9	24	10.0	47.1
PL14-G03	14	22.5	G 3/8	53.5	44.1	6.5	24.0	24	10.0	64.0
PL14-G04	14	22.5	G 1/2	54.5	44.1	8.0	24.0	24	13.0	69.0
PL16-G03	16	25.5	G 3/8	53.5	44.1	6.5	24.0	24	10.0	64.0
PL16-G04	16	25.5	G 1/2	54.5	44.1	8.0	24.0	24	13.0	69.0

**PLF-G: Racor Instantáneo Codo Hembra Cilíndrico**

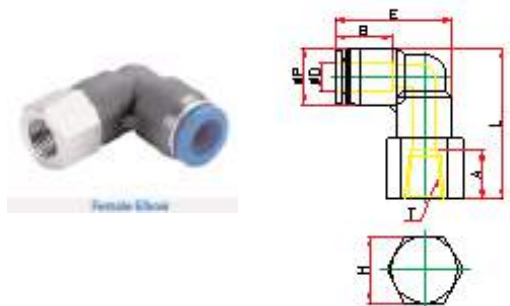

MODELO	D	P	T	L	E	A	B	H	Orificio	PESO
PLF04-M5	4	10.5	M5*0.8p	23.8	23.8	7.0	16.8	10	2.5	9.8
PLF04-M6	4	10.5	M6*1.0p	23.8	23.8	7.0	16.8	10	2.5	9.8
PLF04-G01	4	10.5	R 1/8	24.8	23.8	8.0	16.8	14	2.5	14.8
PLF04-G02	4	10.5	R 1/4	26.8	23.8	10.0	16.8	17	2.5	20.8
PLF06-M5	6	12.5	M5*0.8p	29.8	26.5	7.0	17.6	12	4.0	15.7
PLF06-M6	6	12.5	M6*1.0p	29.8	26.5	7.0	17.6	12	4.0	15.7
PLF06-G01	6	12.5	R 1/8	30.8	26.5	8.0	17.6	14	4.0	16.7
PLF06-G02	6	12.5	R 1/4	32.8	26.5	10.0	17.6	17	4.0	22.7
PLF06-G03	6	12.5	R 3/8	33.8	26.5	11.0	17.6	22	4.0	34.7
PLF06-G04	6	12.5	R 1/2	35.8	26.5	14.0	17.6	24	4.0	36.7
PLF08-G01	8	14.8	R 1/8	33.2	29.7	8.0	18.7	14	6.0	18.7
PLF08-G02	8	14.8	R 1/4	35.2	29.7	10.0	18.7	17	6.0	25.7
PLF08-G03	8	14.8	R 3/8	36.2	29.7	11.0	18.7	22	6.0	37.7
PLF08-G04	8	14.8	R 1/2	38.2	29.7	14.0	18.7	24	6.0	39.7
PLF10-G01	10	17.5	R 1/8	37.3	32.1	8.0	19.6	17	7.0	22.2
PLF10-G02	10	17.5	R 1/4	37.3	32.1	10.0	19.6	17	7.0	28.2
PLF10-G03	10	17.5	R 3/8	38.3	32.1	11.0	19.6	22	7.0	41.2
PLF10-G04	10	17.5	R 1/2	40.3	32.1	14.0	19.6	24	7.0	43.2
PLF12-G02	12	20.5	R 1/4	41.7	36.9	10.0	21.9	19	10.0	39.1
PLF12-G03	12	20.5	R 3/8	42.7	36.9	11.0	21.9	22	10.0	46.1
PLF12-G04	12	20.5	R 1/2	44.7	36.9	14.0	21.9	24	10.0	48.1

PL45 : Racor Instantáneo codo 45° Macho Cónico Or.



MODELO	D	P	T	L	L2	E	A	B	H	Orificio
PL45 04-M5	4	10.5	M5*0.8p	19.5	34.4	16.3	4.0	14.8	10	2.5
PL45 04-M6	4	10.5	M6*1.0p	19.6	34.5	16.3	4.1	14.8	10	3.0
PL45 04-01	4	10.5	R 1/8	23.5	38.4	16.3	8.0	14.8	10	3.0
PL45 04-02	4	10.5	R 1/4	25.5	40.4	16.3	10.0	14.8	14	3.0
PL45 04-03	4	10.5	R 3/8	26.5	41.4	16.3	11.0	14.8	17	3.0
PL45 06-M5	6	13.0	M5*0.8p	20.5	37.3	18.4	4.0	16.4	12	2.5
PL45 06-M6	6	13.0	M6*1.0p	20.6	37.4	18.4	4.1	16.4	12	3.0
PL45 06-01	6	13.0	R 1/8	24.5	41.3	18.4	8.0	16.4	12	4.0
PL45 06-02	6	13.0	R 1/4	27.5	44.3	18.4	10.0	16.4	14	4.0
PL45 06-03	6	13.0	R 3/8	28.5	45.3	18.4	11.0	16.4	17	4.0
PL45 06-04	6	13.0	R 1/2	31.5	48.3	18.4	14.0	16.4	21	4.0
PL45 08-01	8	14.8	R 1/8	26.5	46.5	21.8	8.0	18.3	14	6.0
PL45 08-02	8	14.8	R 1/4	29.5	49.5	21.8	10.0	18.3	14	6.0
PL45 08-03	8	14.8	R 3/8	30.5	50.5	21.8	11.0	18.3	17	6.0
PL45 08-04	8	14.8	R 1/2	33.5	53.5	21.8	14.0	18.3	21	6.0
PL45 10-01	10	17.5	R 1/8	25.9	48.2	23.3	8.0	20.2	17	6.0
PL45 10-02	10	17.5	R 1/4	28.9	51.2	23.3	10.0	20.2	17	8.0
PL45 10-03	10	17.5	R 3/8	29.9	52.2	23.3	11.0	20.2	17	8.0
PL45 10-04	10	17.5	R 1/2	32.9	55.2	23.3	14.0	20.2	21	8.0
PL45 12-01	12	21.0	R 1/8	29.7	55.3	26.5	8.0	22.9	19	6.0
PL45 12-02	12	21.0	R 1/4	31.7	57.3	26.5	10.0	22.9	19	9.0
PL45 12-03	12	21.0	R 3/8	32.7	58.3	26.5	11.0	22.9	19	10.0
PL45 12-04	12	21.0	R 1/2	35.7	61.3	26.5	14.0	22.9	21	10.0

PLL: Racor Instantáneo Codo Prolongador Cónico Or.

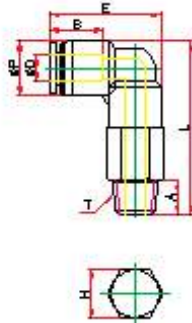

MODELO	D	P	T	L	E	A	B	H1	Orificio	PESO
PLL04-M5	4	10.5	M5*0.8p	38.8	23.8	4.6	16.8	10	2.0	15.8
PLL04-M6	4	10.5	M6*1.0p	38.5	23.8	4.3	16.8	10	3.0	15.8
PLL04-01	4	10.5	R 1/8	40.8	23.8	8.0	16.8	10	3.0	15.8
PLL04-02	4	10.5	R 1/4	42.8	23.8	10.0	16.8	14	3.0	26.8
PLL04-03	4	10.5	R 3/8	43.8	23.8	11.0	16.8	17	3.0	40.8
PLL06-M5	6	12.5	M5*0.8p	44.3	26.5	4.6	17.6	12	2.0	27.7
PLL06-M6	6	12.5	M6*1.0p	44.0	26.5	4.3	17.6	12	3.0	27.7
PLL06-01	6	12.5	R 1/8	46.3	26.5	8.0	17.6	12	4.0	27.7
PLL06-02	6	12.5	R 1/4	48.3	26.5	10.0	17.6	14	4.0	34.7
PLL06-03	6	12.5	R 3/8	49.3	26.5	11.0	17.6	17	4.5	45.7
PLL06-04	6	12.5	R 1/2	52.3	26.5	14.0	17.6	21	4.0	69.7
PLL08-01	8	14.8	R 1/8	51.2	29.7	8.0	18.7	14	6.0	35.7
PLL08-02	8	14.8	R 1/4	53.2	29.7	10.0	18.7	14	6.0	39.7
PLL08-03	8	14.8	R 3/8	54.2	29.7	11.0	18.7	17	6.0	55.7
PLL08-04	8	14.8	R 1/2	57.2	29.7	14.0	18.7	22	6.0	99.7
PLL10-01	10	17.5	R 1/8	48.5	32.1	8.0	19.6	17	6.0	60.2
PLL10-02	10	17.5	R 1/4	50.5	32.1	10.0	19.6	17	7.0	64.2
PLL10-03	10	17.5	R 3/8	51.5	32.1	11.0	19.6	17	7.0	63.2
PLL10-04	10	17.5	R 1/2	54.5	32.1	14.0	19.6	22	7.0	99.2
PLL12-01	12	20.5	R 1/8	64.2	36.9	8.0	21.9	19	8.0	89.1
PLL12-02	12	20.5	R 1/4	66.2	36.9	10.0	21.9	19	8.0	89.1
PLL12-03	12	20.5	R 3/8	67.2	36.9	11.0	21.9	19	10.0	89.1
PLL12-04	12	20.5	R 1/2	70.2	36.9	14.0	21.9	22	10.0	106.1
PLL16-03	16	25.5	R 3/8	82.6	44.1	11.0	24.0	24	10.0	148.0
PLL16-04	16	25.5	R 1/2	85.3	44.1	14.0	24.0	24	13.0	145.0

PLL-G: Racor Instantáneo Codo Prolongador Cilíndrico Or.

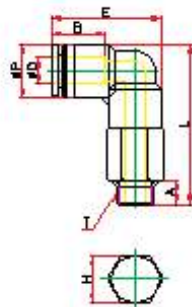

MODELO	D	P	T	L	E	A	B	H	Orificio	PESO
PLL04-G01	4	10.5	G 1/8	39.4	23.8	5.0	16.8	14	2.0	26.8
PLL04-G02	4	10.5	G 1/4	41.4	23.8	6.5	16.8	17	2.0	38.8
PLL04-G03	4	10.5	G 3/8	42.9	23.8	6.5	16.8	20	2.0	53.8
PLL06-G01	6	12.5	G 1/8	45.6	26.5	5.0	17.6	14	4.0	30.7
PLL06-G02	6	12.5	G 1/4	47.6	26.5	6.5	17.6	17	4.0	41.7
PLL06-G03	6	12.5	G 3/8	48.6	26.5	6.5	17.6	20	4.0	55.7
PLL08-G01	8	14.5	G 1/8	50.9	29.7	5.0	18.7	14	6.0	33.7
PLL08-G02	8	14.5	G 1/4	52.9	29.7	6.5	18.7	17	6.0	50.7
PLL08-G03	8	14.5	G 3/8	53.9	29.7	6.5	18.7	20	6.0	61.7
PLL08-G04	8	14.5	G 1/2	54.9	29.7	8.0	18.7	24	6.0	101.7
PLL10-G01	10	17.5	G 1/8	55.4	32.1	5.0	19.6	17	6.0	58.2
PLL10-G02	10	17.5	G 1/4	57.4	32.1	6.5	19.6	17	8.0	55.2
PLL10-G03	10	17.5	G 3/8	58.4	32.1	6.5	19.6	20	8.0	72.2
PLL10-G04	10	17.5	G 1/2	59.4	32.1	8.0	19.6	24	8.0	102.2
PLL12-G02	12	20.5	G 1/4	66.4	36.9	6.5	21.9	19	8.0	82.1
PLL12-G03	12	20.5	G 3/8	67.4	36.9	6.5	21.9	20	10.0	84.1
PLL12-G04	12	20.5	G 1/2	68.4	36.9	8.0	21.9	24	10.0	118.1

PLL

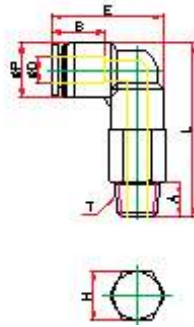

PLL: Racor Instantáneo Codo Prolongador Plástico Cónico Or.

MODELO	D	P	T	L	E	A	B	H1	Orificio	PESO
PLL04-M5	4	10.5	M5*0.8p	38.8	23.8	4.6	16.8	10	2.0	15.8
PLL04-M6	4	10.5	M6*1.0p	38.5	23.8	4.3	16.8	10	3.0	15.8
PLL04-01	4	10.5	R 1/8	40.8	23.8	8.0	16.8	10	3.0	15.8
PLL04-02	4	10.5	R 1/4	42.8	23.8	10.0	16.8	14	3.0	26.8
PLL04-03	4	10.5	R 3/8	43.8	23.8	11.0	16.8	17	3.0	40.8
PLL06-M5	6	12.5	M5*0.8p	44.3	26.5	4.6	17.6	12	2.0	27.7
PLL06-M6	6	12.5	M6*1.0p	44.0	26.5	4.3	17.6	12	3.0	27.7
PLL06-01	6	12.5	R 1/8	46.3	26.5	8.0	17.6	12	4.0	27.7
PLL06-02	6	12.5	R 1/4	48.3	26.5	10.0	17.6	14	4.0	34.7
PLL06-03	6	12.5	R 3/8	49.3	26.5	11.0	17.6	17	4.5	45.7
PLL06-04	6	12.5	R 1/2	52.3	26.5	14.0	17.6	21	4.0	69.7
PLL08-01	8	14.8	R 1/8	51.2	29.7	8.0	18.7	14	6.0	35.7
PLL08-02	8	14.8	R 1/4	53.2	29.7	10.0	18.7	14	6.0	39.7
PLL08-03	8	14.8	R 3/8	54.2	29.7	11.0	18.7	17	6.0	55.7
PLL08-04	8	14.8	R 1/2	57.2	29.7	14.0	18.7	22	6.0	99.7
PLL10-01	10	17.5	R 1/8	48.5	32.1	8.0	19.6	17	6.0	60.2
PLL10-02	10	17.5	R 1/4	50.5	32.1	10.0	19.6	17	7.0	64.2
PLL10-03	10	17.5	R 3/8	51.5	32.1	11.0	19.6	17	7.0	63.2
PLL10-04	10	17.5	R 1/2	54.5	32.1	14.0	19.6	22	7.0	99.2
PLL12-01	12	20.5	R 1/8	64.2	36.9	8.0	21.9	19	8.0	89.1
PLL12-02	12	20.5	R 1/4	66.2	36.9	10.0	21.9	19	8.0	89.1
PLL12-03	12	20.5	R 3/8	67.2	36.9	11.0	21.9	19	10.0	89.1
PLL12-04	12	20.5	R 1/2	70.2	36.9	14.0	21.9	22	10.0	106.1

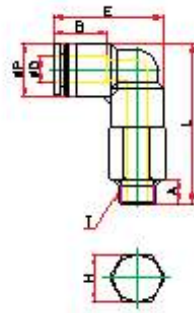

PLL-G: Racor Instantáneo Codo Prolongador Plástico Cilíndrico Or.

MODELO	D	P	T	L	E	A	B	H	Orificio	PESO
PLL04-G01	4	10.5	G 1/8	39.4	23.8	5.0	16.8	14	2.0	26.8
PLL04-G02	4	10.5	G 1/4	41.4	23.8	6.5	16.8	17	2.0	38.8
PLL04-G03	4	10.5	G 3/8	42.9	23.8	6.5	16.8	20	2.0	53.8
PLL06-G01	6	12.5	G 1/8	45.6	26.5	5.0	17.6	14	4.0	30.7
PLL06-G02	6	12.5	G 1/4	47.6	26.5	6.5	17.6	17	4.0	41.7
PLL06-G03	6	12.5	G 3/8	48.6	26.5	6.5	17.6	20	4.0	55.7
PLL08-G01	8	14.5	G 1/8	50.9	29.7	5.0	18.7	14	6.0	33.7
PLL08-G02	8	14.5	G 1/4	52.9	29.7	6.5	18.7	17	6.0	50.7
PLL08-G03	8	14.5	G 3/8	53.9	29.7	6.5	18.7	20	6.0	61.7
PLL08-G04	8	14.5	G 1/2	54.9	29.7	8.0	18.7	24	6.0	101.7
PLL10-G01	10	17.5	G 1/8	55.4	32.1	5.0	19.6	17	6.0	58.2
PLL10-G02	10	17.5	G 1/4	57.4	32.1	6.5	19.6	17	8.0	55.2
PLL10-G03	10	17.5	G 3/8	58.4	32.1	6.5	19.6	20	8.0	72.2
PLL10-G04	10	17.5	G 1/2	59.4	32.1	8.0	19.6	24	8.0	102.2
PLL12-G02	12	20.5	G 1/4	66.4	36.9	6.5	21.9	19	8.0	82.1
PLL12-G03	12	20.5	G 3/8	67.4	36.9	6.5	21.9	20	10.0	84.1
PLL12-G04	12	20.5	G 1/2	68.4	36.9	8.0	21.9	24	10.0	118.1

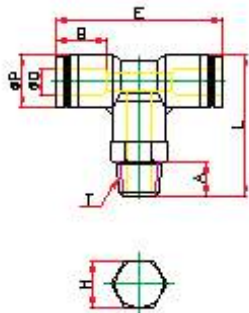

PT : Racor Instantáneo "TE" Macho Central Cónico Or.

MODELO	D	P	T	L	E	A	B	H	Orificio	PESO
PT04-M5	4	10.5	M5*0.8p	20.5	37.3	4.6	16.8	10	2.0	9.6
PT04-M6	4	10.5	M6*1.0p	20.6	37.3	4.1	16.8	10	2.5	9.6
PT04-01	4	10.5	R 1/8	24.5	37.3	8.0	16.8	10	3.0	10.6
PT04-02	4	10.5	R 1/4	26.5	37.3	10.0	16.8	14	3.0	17.6
PT04-03	4	10.5	R 3/8	27.5	37.3	11.0	16.8	17	3.0	25.6
PT06-M5	6	12.5	M5*0.8p	24.0	40.7	4.6	17.6	12	2.0	14.4
PT06-M6	6	12.5	M6*1.0p	22.6	40.7	4.1	17.6	12	3.0	14.4
PT06-01	6	12.5	R 1/8	26.5	40.7	8.0	17.6	12	4.5	16.4
PT06-02	6	12.5	R 1/4	29.5	40.7	10.0	17.6	14	4.5	22.4
PT06-03	6	12.5	R 3/8	30.5	40.7	11.0	17.6	17	4.5	31.4
PT06-04	6	12.5	R 1/2	33.5	40.7	14.0	17.6	21	4.5	48.4
PT08-01	8	14.8	R 1/8	28.0	45.1	8.0	18.7	14	6.0	20.4
PT08-02	8	14.8	R 1/4	31.0	45.1	10.0	18.7	14	6.0	24.4
PT08-03	8	14.8	R 3/8	32.0	45.1	11.0	18.7	17	6.0	32.4
PT08-04	8	14.8	R 1/2	35.0	45.1	14.0	18.7	21	6.5	50.4
PT10-01	10	17.5	R 1/8	28.5	47.4	8.0	19.6	17	6.0	30.4
PT10-02	10	17.5	R 1/4	31.5	47.4	10.0	19.6	17	7.0	35.4
PT10-03	10	17.5	R 3/8	32.5	47.4	11.0	19.6	17	7.0	39.4
PT10-04	10	17.5	R 1/2	35.5	47.4	14.0	19.6	21	7.0	58.4
PT12-01	12	20.5	R 1/8	32.4	55.3	8.0	21.9	19	6.0	45.8
PT12-02	12	20.5	R 1/4	34.4	55.3	10.0	21.9	19	7.0	47.8
PT12-03	12	20.5	R 3/8	35.4	55.3	11.0	21.9	19	10.0	53.8
PT12-04	12	20.5	R 1/2	38.4	55.3	14.0	21.9	21	10.0	59.8
PT16-03	16	25.5	R 3/8	42.8	64.6	11.0	24.0	24	10.0	84.0
PT16-04	16	25.5	R 1/2	45.8	64.6	14.0	24.0	24	13.0	91.0

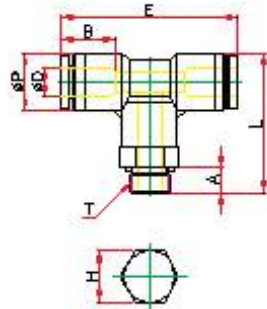

**PT-G: Racor Instantáneo "TE" Central Orientable Cilíndrico**

MODELO	D	P	T	L	E	A	B	H1	Orificio	PESO
PT04-G01	4	10.5	G 1/8	27.8	37.6	5.0	16.8	14	3.0	13.6
PT04-G02	4	10.5	G 1/4	29.8	37.6	6.5	16.8	17	3.0	18.6
PT04-G03	4	10.5	G 3/8	29.3	37.6	6.5	16.8	20	3.0	23.6
PT06-G01	6	12.5	G 1/8	30.8	41.0	5.0	17.6	14	4.0	16.4
PT06-G02	6	12.5	G 1/4	32.8	41.0	6.5	17.6	17	4.0	21.4
PT06-G03	6	12.5	G 3/8	32.8	41.0	6.5	17.6	20	4.0	26.4
PT08-G01	8	14.5	G 1/8	33.3	44.4	5.0	18.7	14	6.0	18.4
PT08-G02	8	14.5	G 1/4	35.3	44.4	6.5	18.7	17	6.0	25.4
PT08-G03	8	14.5	G 3/8	35.3	44.4	6.5	18.7	20	6.0	29.4
PT08-G04	8	14.5	G 1/2	36.3	44.4	8.0	18.7	24	6.0	40.4
PT10-G01	10	17.5	G 1/8	35.3	47.2	5.0	19.6	17	7.0	28.4
PT10-G02	10	17.5	G 1/4	37.3	47.2	6.5	19.6	17	7.0	27.4
PT10-G03	10	17.5	G 3/8	37.3	47.2	6.5	19.6	20	7.0	33.4
PT10-G04	10	17.5	G 1/2	38.3	47.2	8.0	19.6	24	7.0	45.4
PT12-G02	12	20.5	G 1/4	42.7	54.8	6.5	21.9	19	8.0	40.2
PT12-G03	12	20.5	G 3/8	42.7	54.8	6.5	21.9	20	10.0	42.2
PT12-G04	12	20.5	G 1/2	43.7	54.8	8.0	21.9	24	10.0	53.2
PT16-G03	16	25.5	G 3/8	53.6	64.6	6.5	24.0	24	10.0	80.0
PT16-G04	16	25.5	G 1/2	54.6	64.6	8.0	24.0	24	13.0	84.0

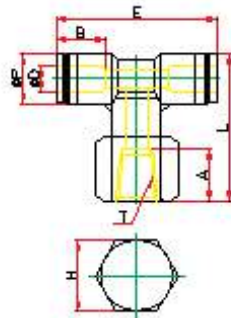

**PTF-G: Racor Instantáneo "TE" Hembra Central Cilíndrico Or.**

MODELO	D	P	T	L	E	A	B	H	Orificio	PESO
PTF04-M5	4	10.5	M5*0.8p	21.5	37.6	7.0	16.8	10	2.5	11.6
PTF04-M6	4	10.5	M6*1.0p	21.5	37.6	7.0	16.8	10	2.5	11.6
PTF04-G01	4	10.5	R 1/8	22.5	37.6	8.0	16.8	14	2.5	15.6
PTF04-G02	4	10.5	R 1/4	24.5	37.6	10.0	16.8	17	2.5	21.6
PTF06-M5	6	12.5	M5*0.8p	23.5	41.0	7.0	17.6	12	4.0	17.4
PTF06-M6	6	12.5	M6*1.0p	23.5	41.0	7.0	17.6	12	4.0	17.4
PTF06-G01	6	12.5	R 1/8	24.5	41.0	8.0	17.6	14	4.0	18.4
PTF06-G02	6	12.5	R 1/4	26.5	41.0	10.0	17.6	17	4.0	24.4
PTF06-G03	6	12.5	R 3/8	27.5	41.0	11.0	17.6	22	4.0	38.4
PTF08-G01	8	14.8	R 1/8	26.0	44.4	8.0	18.7	14	6.0	22.4
PTF08-G02	8	14.8	R 1/4	28.0	44.4	10.0	18.7	17	6.0	27.4
PTF08-G03	8	14.8	R 3/8	29.0	44.4	11.0	18.7	22	6.0	40.4
PTF08-G04	8	14.8	R 1/2	31.0	44.4	14.0	18.7	24	6.0	41.4
PTF10-G01	10	17.5	R 1/8	28.5	47.2	8.0	19.6	17	7.0	38.4
PTF10-G02	10	17.5	R 1/4	28.5	47.2	10.0	19.6	17	7.0	33.4
PTF10-G03	10	17.5	R 3/8	29.5	47.2	11.0	19.6	22	7.0	46.4
PTF10-G04	10	17.5	R 1/2	31.5	47.2	14.0	19.6	24	7.0	46.4
PTF12-G02	12	20.5	R1/4	31.4	54.8	10.0	21.9	19	10.0	46.2
PTF12-G03	12	20.5	R 3/8	32.4	54.8	11.0	21.9	22	10.0	53.2
PTF12-G04	12	20.5	R 1/2	34.4	54.8	14.0	21.9	24	10.0	54.2

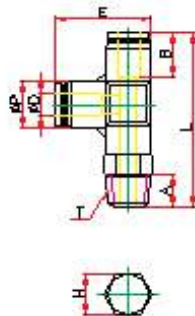

**PST: Racor Instantáneo "TE" Lateral Macho Cónico Or.**

MODELO	D	P	T	L	E	A	B	H	Orificio	PESO
PST04-M5	4	10.5	M5*0.8p	42.3	25.1	4.6	16.8	10	2.0	10.6
PST04-M6	4	10.5	M6*1.0p	41.3	25.1	4.1	16.8	10	2.5	10.6
PST04-01	4	10.5	R 1/8	45.3	25.1	8.0	16.8	10	3.0	11.6
PST04-02	4	10.5	R 1/4	48.3	25.1	10.0	16.8	14	3.0	17.6
PST04-03	4	10.5	R 3/8	48.3	25.1	11.0	16.8	17	3.0	26.6
PST06-M5	6	12.5	M5*0.8p	46.1	28.1	4.6	17.6	12	2.0	15.4
PST06-M6	6	12.5	M6*1.0p	46.1	28.1	4.6	17.6	12	2.0	15.4
PST06-01	6	12.5	R 1/8	48.6	28.1	8.0	17.6	12	4.5	17.4
PST06-02	6	12.5	R 1/4	51.2	28.1	10.0	17.6	14	4.5	25.4
PST06-03	6	12.5	R 3/8	52.2	28.1	11.0	17.6	17	4.5	29.4
PST06-04	6	12.5	R 1/2	55.5	28.1	14.0	17.6	21	4.5	32.4
PST08-01	8	14.8	R 1/8	52.2	30.9	8.0	18.7	14	6.0	22.4
PST08-02	8	14.8	R 1/4	55.2	30.9	10.0	18.7	14	6.0	27.4
PST08-03	8	14.8	R 3/8	56.2	30.9	11.0	18.7	17	6.0	34.4
PST08-04	8	14.8	R 1/2	59.2	30.9	14.0	18.7	21	6.5	53.4
PST10-01	10	17.5	R 1/8	55.6	34.6	8.0	19.6	17	6.0	28.4
PST10-02	10	17.5	R 1/4	58.6	34.6	10.0	19.6	17	7.0	34.4
PST10-03	10	17.5	R 3/8	59.6	34.6	11.0	19.6	17	7.0	38.4
PST10-04	10	17.5	R 1/2	62.6	34.6	14.0	19.6	21	7.0	58.4
PST12-02	12	20.5	R 1/4	64.8	40.3	10.0	21.9	19	7.0	50.8
PST12-03	12	20.5	R 3/8	65.8	40.3	11.0	21.9	19	10.0	53.8
PST12-04	12	20.5	R 1/2	68.8	40.3	14.0	21.9	21	10.0	61.8

**PST-G: Racor Instantáneo "TE" Lateral Cilíndrico Or.**

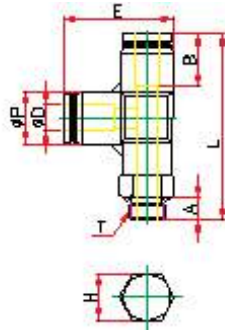

MODELO	D	P	T	L	E	A	B	H	Orificio	PESO
PST04-G01	4	10.5	G 1/8	42.8	25.1	5.0	16.8	14	3.0	14.6
PST04-G02	4	10.5	G 1/4	44.8	25.1	6.5	16.8	17	3.0	18.6
PST04-G03	4	10.5	G 3/8	44.3	25.1	6.5	16.8	20	3.0	23.6
PST06-G01	6	12.5	G 1/8	46.9	28.1	5.0	17.6	14	4.0	16.4
PST06-G02	6	12.5	G 1/4	48.9	28.1	6.5	17.6	17	4.0	22.4
PST06-G03	6	12.5	G 3/8	49.9	28.1	6.5	17.6	20	4.0	27.4
PST08-G01	8	14.5	G 1/8	50.1	30.9	5.0	18.7	14	6.0	19.4
PST08-G02	8	14.5	G 1/4	52.1	30.9	6.5	18.7	17	6.0	25.4
PST08-G03	8	14.5	G 3/8	53.1	30.9	6.5	18.7	20	6.0	30.4
PST08-G04	8	14.5	G 1/2	54.1	30.9	8.0	18.7	24	6.0	40.4
PST10-G01	10	17.5	G 1/8	53.8	34.6	5.0	19.6	17	6.0	28.4
PST10-G02	10	17.5	G 1/4	55.8	34.6	6.5	19.6	17	8.0	28.4
PST10-G03	10	17.5	G 3/8	56.8	34.6	6.5	19.6	20	8.0	34.4
PST10-G04	10	17.5	G 1/2	57.8	34.6	8.0	19.6	24	8.0	48.4
PST12-G02	12	20.5	G 1/4	62.2	40.3	6.5	21.9	19	8.0	43.2
PST12-G03	12	20.5	G 3/8	63.2	40.3	6.5	21.9	20	10.0	43.2
PST12-G04	12	20.5	G 1/2	64.2	40.3	8.0	21.9	24	10.0	55.2

**PWT: Racor Instantáneo "Y" Tubo - Rosca Cónica Or.**

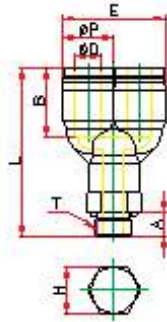

MODELO	D	P	T	L	E	A	B	H	Orificio	PESO
PWT04-M5	4	10.5	M5*0.8p	41.1	21.0	4.6	15.7	10	2.5	10.6
PWT04-M6	4	10.5	M6*1.0p	41.1	21.0	4.1	15.7	10	2.5	10.6
PWT04-01	4	10.5	R 1/8	43.6	21.0	8.0	15.7	10	3.0	11.6
PWT04-02	4	10.5	R 1/4	45.6	21.0	10.0	15.7	14	3.0	17.6
PWT04-03	4	10.5	R 3/8	46.6	21.0	11.0	15.7	17	3.0	25.6
PWT06-M5	6	12.5	M5*0.8p	42.0	25.0	4.6	17.0	12	2.5	15.4
PWT06-M6	6	12.5	M6*1.0p	40.6	25.0	4.1	17.0	12	3.0	15.4
PWT06-01	6	12.5	R 1/8	44.5	25.0	8.0	17.0	12	4.5	18.4
PWT06-02	6	12.5	R 1/4	47.5	25.0	10.0	17.0	14	4.5	19.4
PWT06-03	6	12.5	R 3/8	48.5	25.0	11.0	17.0	17	4.5	31.4
PWT06-04	6	12.5	R 1/2	51.5	25.0	14.0	17.0	21	4.5	45.4
PWT08-01	8	14.8	R 1/8	47.9	29.0	8.0	19.1	14	6.0	19.4
PWT08-02	8	14.8	R 1/4	50.9	29.0	10.0	19.1	14	6.0	25.4
PWT08-03	8	14.8	R 3/8	51.9	29.0	11.0	19.1	17	6.0	33.4
PWT08-04	8	14.8	R 1/2	54.9	29.0	14.0	19.1	21	6.5	51.4
PWT10-01	10	17.5	R 1/8	51.2	35.2	8.0	20.2	17	6.0	31.4
PWT10-02	10	17.5	R 1/4	54.2	35.2	10.0	20.2	17	7.0	36.4
PWT10-03	10	17.5	R 3/8	55.2	35.2	11.0	20.2	17	7.0	38.4
PWT10-04	10	17.5	R 1/2	58.2	35.2	14.0	20.2	21	7.0	58.4
PWT12-01	12	20.5	R 1/8	57.2	42.0	8.0	22.7	19	6.0	48.2
PWT12-02	12	20.5	R 1/4	59.2	42.0	10.0	22.7	19	7.0	51.2
PWT12-03	12	20.5	R 3/8	60.2	42.0	11.0	22.7	19	10.0	50.2
PWT12-04	12	20.5	R 1/2	63.2	42.0	14.0	22.7	21	10.0	62.2

**PWT-G : Racor Instantáneo "Y" Tubo Rosca Cilíndrica Or.**

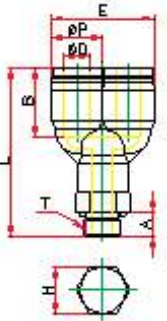

MODELO	D	P	T	L	E	A	B	H	Orificio	PESO
PWT04-G01	4	10.5	G 1/8	41.6	21.0	5.0	15.7	14	3.0	14.6
PWT04-G02	4	10.5	G 1/4	43.6	21.0	6.5	15.7	17	3.0	18.6
PWT04-G03	4	10.5	G 3/8	43.6	21.0	6.5	15.7	20	3.0	22.6
PWT06-G01	6	12.5	G 1/8	42.5	25.0	5.0	17.0	14	4.0	17.4
PWT06-G02	6	12.5	G 1/4	44.5	25.0	6.5	17.0	17	4.0	22.4
PWT06-G03	6	12.5	G 3/8	44.5	25.0	6.5	17.0	20	4.0	26.4
PWT06-G04	6	12.5	G 1/2	45.5	25.0	8.0	17.0	24	4.0	37.4
PWT08-G01	8	14.5	G 1/8	45.9	29.0	5.0	19.1	14	6.0	18.4
PWT08-G02	8	14.5	G 1/4	47.9	29.0	6.5	19.1	17	6.0	25.4
PWT08-G03	8	14.5	G 3/8	47.9	29.0	6.5	19.1	20	6.0	30.4
PWT08-G04	8	14.5	G 1/2	48.9	29.0	8.0	19.1	24	6.0	40.4
PWT10-G01	10	17.5	G 1/8	49.2	35.2	5.0	20.2	17	6.0	29.4
PWT10-G02	10	17.5	G 1/4	51.2	35.2	6.5	20.2	17	7.0	28.4
PWT10-G03	10	17.5	G 3/8	51.2	35.2	6.5	20.2	20	7.0	35.4
PWT10-G04	10	17.5	G 1/2	52.2	35.2	8.0	20.2	24	7.0	47.4
PWT12-G02	12	20.5	G 1/4	56.2	42.0	6.5	22.7	19	8.0	44.2
PWT12-G03	12	20.5	G 3/8	56.2	42.0	6.5	22.7	20	9.0	45.2
PWT12-G04	12	20.5	G 1/2	57.2	42.0	8.0	22.7	24	9.0	58.2

**PLM : Racor Instantáneo Pasamuros Codo**

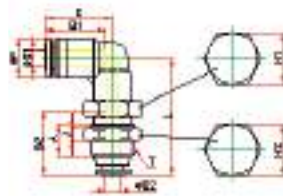

MODELO	D	P	T	L	E	A	B1	B2	J	H1-H2	Orificio	PESO	
PLM04	4	10.5	M12*1.0p	32.4	18.7	9.0	16.3	16.3	4.0	14	14	3.0	12.6
PLM06	6	12.5	M14*1.0p	38.2	20.4	11.0	17.5	17.0	4.0	17	17	4.5	14.5
PLM08	8	14.5	M16*1.0p	40.3	23.1	11.5	19.1	18.6	5.0	19	19	6.0	20.4
PLM10	10	17.5	M20*1.0p	42.3	23.7	12.0	19.7	20.3	5.0	24	24	7.0	29.7
PLM12	12	20.5	M22*1.0p	48.1	27.7	15.0	22.2	23.4	5.0	26	26	10.0	43.4

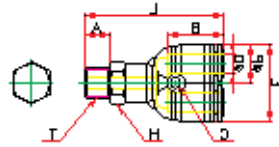

**PXT : Racor Instantáneo 4 salidas en X Rosca Cónica**

MODELO	D	P	T	L	E	C	A	B	H(Hex)	Orificio	PESO
PXT04-01	4	10.5	R 1/8	44.2	21.0	3.3	8.0	15.7	10	2.0	20.0
PXT04-02	4	10.5	R 1/4	48.2	21.0	3.3	10.0	15.7	14	2.0	25.7
PXT06-01	6	12.5	R 1/8	47.9	25.0	3.3	8.0	17.0	12	3.5	25.4
PXT06-02	6	12.5	R 1/4	50.9	25.0	3.3	10.0	17.0	14	4.6	27.0

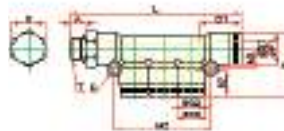

**PKD : Racor Instantáneo Cónico TE distribución Reducción 3 x 2**

MODELO	D1	D2	P1	P2	T	L	E	C	A	B1	B2	M1	M2	H Ori.	PESO
PKD0604-01	6	4	12.5	10.5	R 1/8	72.1	24.2	3.3	8.0	17.6	16.3	7.6	34.0	12 3.0	21.1
PKD0804-01	8	4	14.8	10.5	R 1/8	73.9	28.5	4.3	8.0	18.7	16.3	9.2	34.8	14 3.0	23.1
PKD0804-02	8	4	14.8	10.5	R 1/4	76.9	28.5	4.3	10.0	18.7	16.3	9.2	34.8	14 3.0	28.1
PKD0806-01	8	6	14.8	12.5	R 1/8	79.5	34.0	4.3	8.0	18.7	17.6	9.3	41.1	14 4.0	26.8
PKD0806-02	8	6	14.8	12.5	R 1/4	82.5	34.0	4.3	10.0	18.7	17.6	9.3	41.1	14 4.0	30.8
PKD1006-02	10	6	17.5	12.5	R 1/4	89.2	34.5	4.3	10.0	19.6	17.6	9.5	41.7	17 4.0	40.3
PKD1006-03	10	6	17.5	12.5	R 3/8	90.2	34.5	4.3	11.0	19.6	17.6	9.5	41.7	17 4.0	44.3
PKD1008-02	10	8	17.5	14.8	R 1/4	94.3	34.5	4.3	10.0	19.6	18.7	8.5	47.0	17 6.5	44.3
PKD1008-03	10	8	17.5	14.8	R 3/8	95.3	34.5	4.3	11.0	19.6	18.7	8.5	47.0	17 6.5	48.3

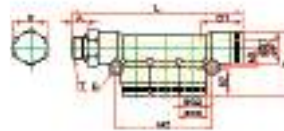

**PKD-G : Racor Instantáneo Cilíndrico TE distribución Reducción 3 x 2**

MODELO	D1	D2	P1	P2	T	L	E	C	A	B1	B2	M1	M2	H Ori.	Peso
PKD0604-G01	6	4	12.5	10.5	G 1/8	70.1	24.2	3.3	5.0	17.6	16.3	7.6	34.0	14 3.0	22.1
PKD0804-G01	8	4	14.8	10.5	G 1/8	71.9	28.5	4.3	5.0	18.7	16.3	9.2	34.8	14 3.0	24.1
PKD0804-G02	8	4	14.8	10.5	G 1/4	74.9	28.5	4.3	6.5	18.7	16.3	9.2	34.8	17 3.0	29.1
PKD0806-G01	8	6	14.8	12.5	G 1/8	77.5	34.0	4.3	5.0	18.7	17.6	9.3	41.1	14 4.0	27.8
PKD0806-G02	8	6	14.8	12.5	G 1/4	80.5	34.0	4.3	6.5	18.7	17.6	9.3	41.1	17 4.0	27.8
PKD1006-G02	10	6	17.5	12.5	G 1/4	87.2	34.5	4.3	6.5	19.6	17.6	9.5	41.7	17 4.0	31.8
PKD1006-G03	10	6	17.5	12.5	G 3/8	87.2	34.5	4.3	6.5	19.6	17.6	9.5	41.7	20 4.0	35.3
PKD1008-G02	10	8	17.5	14.8	G 1/4	92.3	34.5	4.3	6.5	19.6	18.7	8.5	47.0	17 6.5	41.3
PKD1008-G03	10	8	17.5	14.8	G 3/8	92.3	34.5	4.3	6.5	19.6	18.7	8.5	47.0	20 6.5	53.3

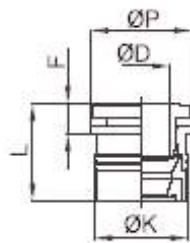

**CAS: Racor Instantáneo Insertable**

MODELO	D	P	K	L	F	PESO
CAS04	4	10.0	8.95	11.25	3.55	1.5
CAS06	6	12.0	11.10	12.45	3.95	2.3
CAS08	8	14.0	13.20	13.9	4.3	3.5
CAS10	10	16.6	15.45	15.15	4.85	4.8
CAS12	12	19.0	17.75	17.4	5.0	7.3

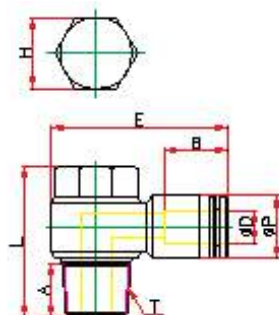

**PH: Racor Instantáneo "Codo Banjo" Cónico Or.**

MODELO	D	P	T	L	E	A	B	H	Orificio	PESO
PH04-01	4	10.5	G 1/8	23.5	32.4	4.5	16.3	8	3.0	14.8
PH04-02	4	10.5	G 1/4	28.0	34.2	6.0	16.3	12	3.2	24.8
PH06-01	6	12.5	G 1/8	23.5	33.5	4.5	17.6	8	3.0	15.7
PH06-02	6	12.5	G 1/4	28.0	37.3	6.0	17.6	12	4.5	23.7
PH06-03	6	12.5	G 3/8	32.5	39.8	6.0	17.6	14	5.0	47.7
PH08-01	8	14.5	G 1/8	23.5	34.2	4.5	18.7	8	3.0	16.7
PH08-02	8	14.5	G 1/4	28.0	38.3	6.0	18.7	12	4.5	25.7
PH08-03	8	14.5	G 3/8	32.5	41.8	6.0	18.7	14	6.0	49.7
PH08-04	8	14.5	G 1/2	34.0	45.9	7.5	18.7	19	6.5	68.7
PH10-02	10	17.5	G 1/4	28.0	39.5	6.0	19.6	12	4.5	27.2
PH10-03	10	17.5	G 3/8	32.5	42.5	6.0	19.6	14	6.0	50.2
PH10-04	10	17.5	G 1/2	34.0	48.6	7.5	19.6	19	8.0	73.2
PH12-03	12	20.5	G 3/8	32.5	44.8	6.0	21.9	14	6.0	53.1
PH12-04	12	20.5	G 1/2	34.0	50.3	7.5	21.9	19	8.0	73.1

PH-G: Racor Instantáneo "Codo Banjo" Cilíndrico Or.

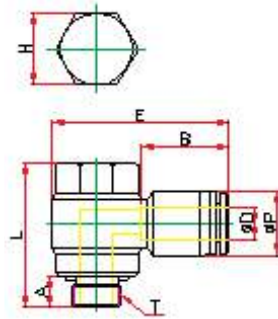

MODELO	D	P	T	L	E	A	B	H	Orificio	PESO
PH04-G01	4	10.5	G 1/8	23.5	32.4	4.5	16.3	8	3.0	14.8
PH04-G02	4	10.5	G 1/4	28.0	34.2	6.0	16.3	12	3.2	24.8
PH06-G01	6	12.5	G 1/8	23.5	33.5	4.5	17.6	8	3.0	15.7
PH06-G02	6	12.5	G 1/4	28.0	37.3	6.0	17.6	12	4.5	23.7
PH06-G03	6	12.5	G 3/8	32.5	39.8	6.0	17.6	14	5.0	47.7
PH08-G01	8	14.5	G 1/8	23.5	34.2	4.5	18.7	8	3.0	16.7
PH08-G02	8	14.5	G 1/4	28.0	38.3	6.0	18.7	12	4.5	25.7
PH08-G03	8	14.5	G 3/8	32.5	41.8	6.0	18.7	14	6.0	49.7
PH08-G04	8	14.5	G 1/2	34.0	45.9	7.5	18.7	19	6.5	68.7
PH10-G02	10	17.5	G 1/4	28.0	39.5	6.0	19.6	12	4.5	27.2
PH10-G03	10	17.5	G 3/8	32.5	42.5	6.0	19.6	14	6.0	50.2
PH10-G04	10	17.5	G 1/2	34.0	48.6	7.5	19.6	19	8.0	73.2
PH12-G03	12	20.5	G 3/8	32.5	44.8	6.0	21.9	14	6.0	53.1
PH12-G04	12	20.5	G 1/2	34.0	50.3	7.5	21.9	19	8.0	73.1

PHF: Racor Instantáneo "Codo Banjo" Unión Rosca MxH Cónica Or.

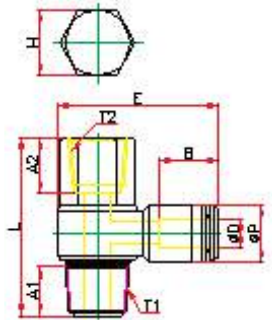

MODELO	D	P	T1-T2	L	E	A1	A2	B	H	Orificio	PESO
PHF04-M5	4	10.5	M5*0.8p	20.0	25.1	3.6	7.0	16.3	8	1.5	7.8
PHF04-01	4	10.5	R 1/8	30.2	30.5	8.0	8.0	16.3	14	3.0	19.8
PHF04-02	4	10.5	R 1/4	35.5	34.5	10.0	10.0	16.3	17	3.2	30.8
PHF06-M5	6	12.5	M5*0.8p	20.0	27.8	3.6	7.0	17.6	8	1.5	8.7
PHF06-01	6	12.5	R 1/8	30.2	31.2	8.0	8.0	17.6	14	3.0	20.7
PHF06-02	6	12.5	R 1/4	35.5	35.0	10.0	10.0	17.6	17	4.0	30.7
PHF06-03	6	12.5	R 3/8	41.2	38.7	11.0	11.0	17.6	21	5.0	54.7
PHF08-01	8	14.8	R 1/8	30.2	33.0	8.0	8.0	18.7	14	3.0	20.7
PHF08-02	8	14.8	R 1/4	35.5	36.8	10.0	10.0	18.7	17	4.0	31.7
PHF08-03	8	14.8	R 3/8	41.2	40.1	11.0	11.0	18.7	21	5.0	55.7
PHF08-04	8	14.8	R 1/2	50.0	45.8	14.0	14.0	18.7	24	6.0	87.7
PHF10-02	10	17.5	R 1/4	35.5	38.8	10.0	10.0	19.6	17	4.0	33.2
PHF10-03	10	17.5	R 3/8	41.2	42.2	11.0	11.0	19.6	21	5.0	57.2
PHF10-04	10	17.5	R 1/2	50.0	47.5	14.0	14.0	19.6	24	6.0	89.2
PHF12-03	12	20.5	R 3/8	41.2	45.9	11.0	11.0	21.9	21	5.0	67.1
PHF12-04	12	20.5	R 1/2	50.0	50.1	14.0	14.0	21.9	24	6.0	90.1

PHF-G : Racor Instantáneo "Codo Banjo" Unión Rosca MxH Cilíndrica Or.

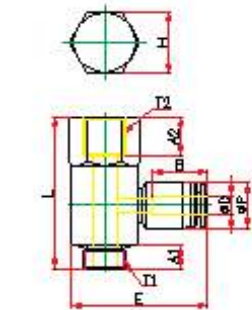

MODELO	D	P	T	L	E	A	B	H	Orificio	PESO	
PHF04-G01	4	10.5	G 1/8	33.9	31.2	5.0	8.0	16.2	14	3.0	22.8
PHF04-G02	4	10.5	G 1/4	42.4	34.6	6.5	10.0	16.2	17	3.2	36.8
PHF06-G01	6	12.5	G 1/8	33.9	31.9	5.0	8.0	17.0	14	3.0	23.7
PHF06-G02	6	12.5	G 1/4	42.4	35.3	6.5	10.0	17.0	17	4.0	39.7
PHF06-G03	6	12.5	G 3/8	44.4	39.1	6.5	11.0	17.0	21	5.0	57.7
PHF08-G01	8	14.8	G 1/8	33.9	33.8	5.0	8.0	19.1	14	3.0	23.7
PHF08-G02	8	14.8	G 1/4	42.4	37.1	6.5	10.0	19.1	17	4.0	40.7
PHF08-G03	8	14.8	G 3/8	44.4	40.9	6.5	11.0	19.1	21	5.0	60.7
PHF08-G04	8	14.8	G 1/2	49.9	44.0	8.0	14.0	19.1	24	6.0	78.7
PHF10-G02	10	17.5	G 1/4	42.4	39.0	6.5	10.0	20.2	17	4.0	42.2
PHF10-G03	10	17.5	G 3/8	44.4	43.1	6.5	11.0	20.2	21	5.0	63.2
PHF10-G04	10	17.5	G 1/2	49.9	46.4	8.0	14.0	20.2	24	6.0	81.2
PHF12-G02	12	20.5	G 1/4	42.4	42.3	6.5	10.0	22.7	17	4.0	45.1
PHF12-G03	12	20.5	G 3/8	44.4	46.3	6.5	11.0	22.7	21	5.0	66.1
PHF12-G04	12	20.5	G 1/2	49.9	50.2	8.0	14.0	22.7	24	6.0	84.1

PHL(2) : Racor Instantáneo Pasamuros Recto

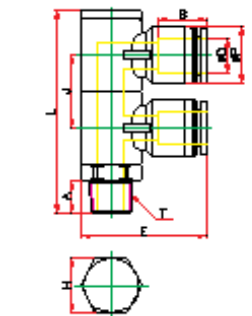

MODELO	D	P	T	L	E	A	B	J	H	Orificio	PESO
PHL04-01(2)	4	10.5	R 1/8	51.9	31.2	8.0	16.2	17.9	14	3.0	35.6
PHL04-02(2)	4	10.5	R 1/4	62.9	34.6	10.0	16.2	21.9	17	3.2	54.6
PHL04-03(2)	4	10.5	R 3/8	64.9	38.4	11.0	16.2	21.9	21	3.2	81.6
PHL06-01(2)	6	12.5	R 1/8	51.9	31.9	8.0	17.0	17.9	14	3.0	36.4
PHL06-02(2)	6	12.5	R 1/4	62.9	35.3	10.0	17.0	21.9	17	4.0	55.4
PHL06-03(2)	6	12.5	R 3/8	64.9	39.1	11.0	17.0	21.9	21	5.0	82.4
PHL08-01(2)	8	14.5	R 1/8	51.9	33.8	8.0	19.1	17.9	14	3.0	38.4
PHL08-02(2)	8	14.5	R 1/4	62.9	37.1	10.0	19.1	21.9	17	4.0	57.4
PHL08-03(2)	8	14.5	R 3/8	64.9	40.9	11.0	19.1	21.9	21	5.0	82.4
PHL08-04(2)	8	14.5	R 1/2	73.8	44.0	14.0	19.1	23.9	24	6.0	118.4
PHL10-02(2)	10	17.5	R 1/4	62.9	39.0	10.0	20.2	21.9	17	4.0	58.4
PHL10-03(2)	10	17.5	R 3/8	64.9	43.1	11.0	20.2	21.9	21	5.0	83.4
PHL10-04(2)	10	17.5	R 1/2	73.8	46.4	14.0	20.2	23.9	24	6.0	19.4
PHL12-02(2)	12	20.5	R 1/4	62.9	42.3	10.0	22.7	21.9	17	4.0	60.2
PHL12-03(2)	12	20.5	R 3/8	64.9	46.3	11.0	22.7	21.9	21	5.0	85.2
PHL12-04(2)	12	20.5	R 1/2	73.8	50.2	14.0	22.7	23.9	24	6.0	121.2

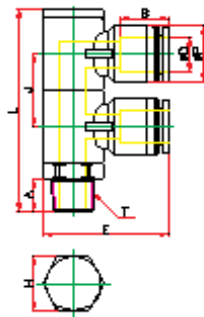

**PHL-G (2): Racor Instantáneo "Codo Banjo" Doble Cilíndrico Or.**

MODELO	D	P	T	L	E	A	B	J	H	Orificio	PESO
PHL04-G01(2)	4	10.5	R 1/8	51.9	31.2	8.0	16.2	17.9	14	3.0	35.6
PHL04-G02(2)	4	10.5	R 1/4	62.9	34.6	10.0	16.2	21.9	17	3.2	54.6
PHL04-G03(2)	4	10.5	R 3/8	64.9	38.4	11.0	16.2	21.9	21	3.2	81.6
PHL06-G01(2)	6	12.5	R 1/8	51.9	31.9	8.0	17.0	17.9	14	3.0	36.4
PHL06-G02(2)	6	12.5	R 1/4	62.9	35.3	10.0	17.0	21.9	17	4.0	55.4
PHL06-G03(2)	6	12.5	R 3/8	64.9	39.1	11.0	17.0	21.9	21	5.0	82.4
PHL08-G01(2)	8	14.5	R 1/8	51.9	33.8	8.0	19.1	17.9	14	3.0	38.4
PHL08-G02(2)	8	14.5	R 1/4	62.9	37.1	10.0	19.1	21.9	17	4.0	57.4
PHL08-G03(2)	8	14.5	R 3/8	64.9	40.9	11.0	19.1	21.9	21	5.0	82.4
PHL08-G04(2)	8	14.5	R 1/2	73.8	44.0	14.0	19.1	23.9	24	6.0	118.4
PHL10-G02(2)	10	17.5	R 1/4	62.9	39.0	10.0	20.2	21.9	17	4.0	58.4
PHL10-G03(2)	10	17.5	R 3/8	64.9	43.1	11.0	20.2	21.9	21	5.0	83.4
PHL10-G04(2)	10	17.5	R 1/2	73.8	46.4	14.0	20.2	23.9	24	6.0	19.4
PHL12-G02(2)	12	20.5	R 1/4	62.9	42.3	10.0	22.7	21.9	17	4.0	60.2
PHL12-G03(2)	12	20.5	R 3/8	64.9	46.3	11.0	22.7	21.9	21	5.0	85.2
PHL12-G04(2)	12	20.5	R 1/2	73.8	50.2	14.0	22.7	23.9	24	6.0	121.2

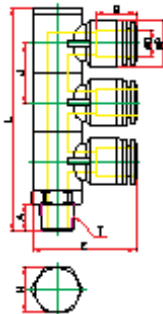

**PHL (3): Racor Instantáneo "Codo Banjo" Triple Cónico Or.**

MODELO	D	P	T	L	E	A	B	J	H	Orificio	PESO
PHL04-01(3)	4	10.5	R 1/8	69.8	31.2	8.0	16.2	17.9	14	3.0	44.4
PHL04-02(3)	4	10.5	R 1/4	84.8	34.6	10.0	16.2	21.9	17	3.2	68.4
PHL04-03(3)	4	10.5	R 3/8	86.8	38.4	11.0	16.2	21.9	21	3.2	101.4
PHL04-04(3)	4	10.5	R 1/2	97.7	42.0	14.0	16.2	23.9	24	3.2	145.4
PHL06-01(3)	6	12.5	R 1/8	69.8	31.9	8.0	17.0	17.9	14	3.0	45.1
PHL06-02(3)	6	12.5	R 1/4	84.8	35.3	10.0	17.0	21.9	17	4.0	69.1
PHL06-03(3)	6	12.5	R 3/8	86.8	39.1	11.0	17.0	21.9	21	5.0	82.1
PHL06-04(3)	6	12.5	R 1/2	97.7	42.2	14.0	17.0	23.9	24	5.0	59.1
PHL08-01(3)	8	14.5	R 1/8	69.8	33.8	8.0	19.1	17.9	14	3.0	57.1
PHL08-02(3)	8	14.5	R 1/4	84.8	37.1	10.0	19.1	21.9	17	4.0	60.1
PHL08-03(3)	8	14.5	R 3/8	86.8	40.9	11.0	19.1	21.9	21	5.0	65.1
PHL08-04(3)	8	14.5	R 1/2	97.7	44.0	14.0	19.1	23.9	24	6.0	85.1
PHL10-01(3)	10	17.5	R 1/8	69.8	35.7	8.0	20.2	17.9	14	3.0	101.6
PHL10-02(3)	10	17.5	R 1/4	84.8	39.0	10.0	20.2	21.9	17	4.0	105.6
PHL10-03(3)	10	17.5	R 3/8	86.8	43.1	11.0	20.2	21.9	21	5.0	112.6
PHL10-04(3)	10	17.5	R 1/2	97.7	46.4	14.0	20.2	23.9	24	6.0	119.6
PHL12-02(3)	12	20.5	R 1/4	84.8	42.3	10.0	22.7	21.9	17	4.0	179.6
PHL12-03(3)	12	20.5	R 3/8	86.8	46.3	11.0	22.7	21.9	21	5.0	185.6
PHL12-04(3)	12	20.5	R 1/2	97.7	50.2	14.0	22.7	23.9	24	6.0	193.6

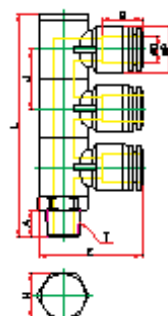

**PHL -G(3): Racor Instantáneo "Codo Banjo" Triple Cilíndrico Or.**

MODELO	D	P	T	L	E	A	B	J	H	Orificio	PESO
PHL04-G01(3)	4	10.5	G 1/8	67.8	31.2	5.0	16.2	17.9	14	3.0	44.4
PHL04-G02(3)	4	10.5	G 1/4	82.8	34.6	6.5	16.2	21.9	17	3.2	68.4
PHL04-G03(3)	4	10.5	G 3/8	83.8	38.4	6.5	16.2	21.9	21	3.2	101.4
PHL04-G04(3)	4	10.5	G 1/2	93.2	42.0	8.0	16.2	23.9	24	3.2	145.4
PHL06-G01(3)	6	12.5	G 1/8	67.8	31.9	5.0	17.0	17.9	14	3.0	45.1
PHL06-G02(3)	6	12.5	G 1/4	82.8	35.3	6.5	17.0	21.9	17	4.0	69.1
PHL06-G03(3)	6	12.5	G 3/8	83.8	39.1	6.5	17.0	21.9	21	5.0	102.1
PHL06-G04(3)	6	12.5	G 1/2	93.2	42.2	8.0	17.0	23.9	24	5.0	146.1
PHL08-G01(3)	8	14.5	G 1/8	67.8	33.8	5.0	19.1	17.9	14	3.0	46.1
PHL08-G02(3)	8	14.5	G 1/4	82.8	37.1	6.5	19.1	21.9	17	4.0	70.1
PHL08-G03(3)	8	14.5	G 3/8	83.8	40.9	6.5	19.1	21.9	21	5.0	103.1
PHL08-G04(3)	8	14.5	G 1/2	93.2	44.0	8.0	19.1	23.9	24	6.0	147.1
PHL10-G01(3)	10	17.5	G 1/8	67.8	35.7	5.0	20.2	17.9	14	3.0	46.6
PHL10-G02(3)	10	17.5	G 1/4	82.8	39.0	6.5	20.2	21.9	17	4.0	70.6
PHL10-G03(3)	10	17.5	G 3/8	83.8	43.1	6.5	20.2	21.9	21	5.0	103.6
PHL10-G04(3)	10	17.5	G 1/2	93.2	46.4	8.0	20.2	23.9	24	6.0	147.6
PHL12-G02(3)	12	20.5	G 1/4	82.8	42.3	6.5	22.7	21.9	17	4.0	72.3
PHL12-G03(3)	12	20.5	G 3/8	83.8	46.3	6.5	22.7	21.9	21	5.0	105.3
PHL12-G04(3)	12	20.5	G 1/2	93.2	50.2	8.0	22.7	23.9	24	6.0	149.3

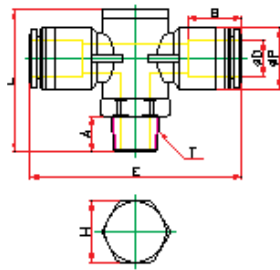

**PHT (1): Racor Instantáneo "TE" simple banjo Cónico Or.**

MODELO	D	P	T	L	E	A	B	H	Orificio	PESO
PHT04-01(1)	4	10.5	R 1/8	33.9	46.9	8.0	16.2	14	3.0	24.6
PHT04-02(1)	4	10.5	R 1/4	40.9	50.6	10.0	16.2	17	3.2	41.6
PHT06-01(1)	6	12.5	R 1/8	33.9	48.3	8.0	17.0	14	3.0	26.4
PHT06-02(1)	6	12.5	R 1/4	40.9	52.0	10.0	17.0	17	4.0	42.4
PHT06-03(1)	6	12.5	R 3/8	42.9	55.8	11.0	17.0	21	5.0	66.4
PHT08-01(1)	8	14.5	R 1/8	33.9	52.1	8.0	19.1	14	3.0	28.4
PHT08-02(1)	8	14.5	R 1/4	40.9	55.6	10.1	19.1	17	4.0	44.4
PHT08-03(1)	8	14.5	R 3/8	42.9	59.4	11.0	19.1	21	5.0	68.4
PHT08-04(1)	8	14.5	R 1/2	49.8	62.3	14.0	19.1	24	6.0	98.4
PHT10-02(1)	10	17.5	R 1/4	40.9	59.5	10.0	20.2	17	4.0	47.4
PHT10-03(1)	10	17.5	R 3/8	42.9	63.7	11.0	20.2	21	5.0	72.4
PHT10-04(1)	10	17.5	R 1/2	49.8	67.2	14.0	20.2	24	6.0	102.4
PHT12-02(1)	12	20.5	R 1/4	40.9	66.0	10.0	22.7	17	4.0	59.2
PHT12-03(1)	12	20.5	R 3/8	42.9	70.2	11.0	22.7	21	5.0	79.2
PHT12-04(1)	12	20.5	R 1/2	49.8	74.7	14.0	22.7	24	6.0	109.2

**PHT-G (1): Racor Instantáneo "TE" simple banjo Cilíndrico Or.**

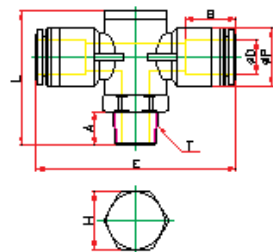

MODELO	D	P	T	L	E	A	B	H	Orificio	PESO
PHT04-G01(1)	4	10.5	G 1/8	31.9	46.9	5.0	16.2	14	3.0	23.6
PHT04-G02(1)	4	10.5	G 1/4	38.9	50.6	6.5	16.2	17	3.2	36.6
PHT06-G01(1)	6	12.5	G 1/8	31.9	48.3	5.0	17.0	14	3.0	23.4
PHT06-G02(1)	6	12.5	G 1/4	38.9	52.0	6.5	17.0	17	4.0	36.4
PHT06-G03(1)	6	12.5	G 3/8	39.9	55.8	6.5	17.0	21	5.0	57.4
PHT08-G01(1)	8	14.5	G 1/8	31.9	52.1	5.0	19.1	14	3.0	24.4
PHT08-G02(1)	8	14.5	G 1/4	38.9	55.6	6.5	19.1	17	4.0	37.4
PHT08-G03(1)	8	14.5	G 3/8	39.9	59.4	6.5	19.1	21	5.0	58.4
PHT08-G04(1)	8	14.5	G 1/2	45.3	62.3	8.0	19.1	24	6.0	84.4
PHT10-G02(1)	10	17.5	G 1/4	38.9	59.5	6.5	20.2	17	4.0	38.4
PHT10-G03(1)	10	17.5	G 3/8	39.9	63.7	6.5	20.2	21	5.0	59.4
PHT10-G04(1)	10	17.5	G 1/2	45.3	67.2	8.0	20.2	24	6.0	85.4
PHT12-G02(1)	12	20.5	G 1/4	38.9	66.0	6.5	22.7	17	4.0	41.2
PHT12-G03(1)	12	20.5	G 3/8	39.9	70.2	6.5	22.7	21	5.0	62.2
PHT12-G04(1)	12	20.5	G 1/2	45.3	74.7	8.0	22.7	24	6.0	88.2

**PHT (2) : Racor Instantáneo "TE" doble banjo Cónico Or.**

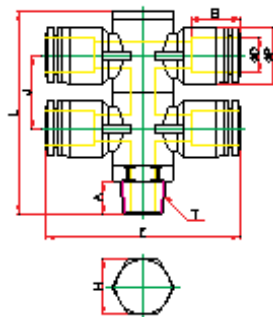

MODELO	D	P	T	L	E	A	B	J	H	Orificio	PESO
PHT04-01(2)	4	10.5	R 1/8	51.9	46.9	8.0	16.2	17.9	14	3.0	39.2
PHT04-02(2)	4	10.5	R 1/4	62.9	50.6	10.0	16.2	21.9	17	3.2	62.2
PHT04-03(2)	4	10.5	R 3/8	64.9	54.4	11.0	16.2	21.9	21	3.2	93.2
PHT06-01(2)	6	12.5	R 1/8	51.9	48.3	8.0	17.0	17.9	14	3.0	41.8
PHT06-02(2)	6	12.5	R 1/4	62.9	52.0	10.0	17.0	21.9	17	4.0	64.8
PHT06-03(2)	6	12.5	R 3/8	64.9	55.8	11.0	17.0	21.9	21	5.0	94.8
PHT08-01(2)	8	14.5	R 1/8	51.9	52.1	8.0	19.1	17.9	14	3.0	44.8
PHT08-02(2)	8	14.5	R 1/4	62.9	55.6	10.0	19.1	21.9	17	4.0	67.8
PHT08-03(2)	8	14.5	R 3/8	64.9	59.4	11.0	19.1	21.9	21	5.0	96.8
PHT08-04(2)	8	14.5	R 1/2	73.8	62.3	14.0	19.1	23.9	24	6.0	138.8
PHT10-02(2)	10	17.5	R 1/4	62.9	59.5	10.0	20.2	21.9	21	5.0	69.8
PHT10-03(2)	10	17.5	R 3/8	64.9	63.7	11.0	20.2	21.9	21	5.0	99.8
PHT10-04(2)	10	17.5	R 1/2	73.8	67.2	14.0	20.2	23.9	24	6.0	144.8
PHT12-02(2)	12	20.5	R 1/4	62.9	66.0	10.0	22.7	21.9	17	4.0	74.4
PHT12-03(2)	12	20.5	R 3/8	64.9	70.2	11.0	22.7	21.9	21	5.0	116.4
PHT12-04(2)	12	20.5	R 1/2	73.8	74.7	14.0	22.7	23.9	24	6.0	158.4

**PHT-G (2) : Racor Instantáneo "TE" doble banjo Cilíndrico Or.**

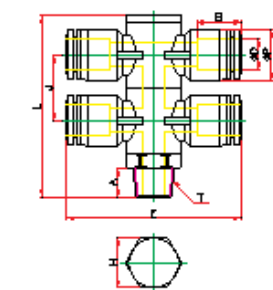

MODELO	D	P	T	L	E	A	B	J	H	Orificio	PESO
PHT04-G01(2)	4	10.5	G 1/8	49.9	46.9	5.0	16.2	17.9	14	3.0	37.2
PHT04-G02(2)	4	10.5	G 1/4	60.9	50.6	6.5	16.2	21.9	17	3.2	56.2
PHT06-G01(2)	6	12.5	G 1/8	49.9	48.3	5.0	17.0	17.9	14	3.0	37.8
PHT06-G02(2)	6	12.5	G 1/4	60.9	52.0	6.5	17.0	21.9	17	4.0	56.8
PHT06-G03(2)	6	12.5	G 3/8	61.9	55.8	6.5	17.0	21.9	21	5.0	83.8
PHT08-G01(2)	8	14.5	G 1/8	49.9	52.1	5.0	19.1	17.9	14	3.0	39.8
PHT08-G02(2)	8	14.5	G 1/4	60.9	55.6	6.5	19.1	21.9	17	4.0	58.8
PHT08-G03(2)	8	14.5	G 3/8	61.9	59.4	6.5	19.1	21.9	21	5.0	63.8
PHT08-G04(2)	8	14.5	G 1/2	69.3	62.3	8.0	19.1	23.9	24	6.0	119.8
PHT10-G02(2)	10	17.5	G 1/4	60.9	59.5	6.5	20.2	21.9	17	4.0	58.8
PHT10-G03(2)	10	17.5	G 3/8	61.9	63.7	6.5	20.2	21.9	21	5.0	83.8
PHT10-G04(2)	10	17.5	G 1/2	69.3	67.2	8.0	20.2	23.9	24	6.0	119.8
PHT12-G02(2)	12	20.5	G 1/4	60.9	66.0	6.5	22.7	21.9	17	4.0	60.4
PHT12-G03(2)	12	20.5	G 3/8	61.9	70.2	6.5	22.7	21.9	21	5.0	85.4
PHT12-G04(2)	12	20.5	G 1/2	69.3	74.7	8.0	22.7	23.9	24	6.0	121.4

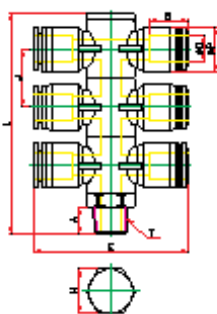

**PHT (3) : Racor Instantáneo Cónico "TE" Triple Banjo**

MODELO	D	P	T	L	E	A	B	H1	H2	Orificio	PESO
PHT04-01(3)	4	10.5	R 1/8	69.8	46.9	8.0	16.2	17.9	14	3.0	50.8
PHT04-02(3)	4	10.5	R 1/4	84.8	50.6	10.0	16.2	21.9	17	3.2	81.8
PHT04-03(3)	4	10.5	R 3/8	86.8	54.4	11.0	16.2	21.9	21	3.2	121.8
PHT06-01(3)	6	12.5	R 1/8	69.8	48.3	8.0	17.0	17.9	14	3.0	55.2
PHT06-02(3)	6	12.5	R 1/4	84.8	52.0	10.0	17.0	21.9	17	4.0	86.2
PHT06-03(3)	6	12.5	R 3/8	86.8	55.8	11.0	17.0	21.9	21	5.0	125.2
PHT06-04(3)	6	12.5	R 1/2	97.7	58.7	14.0	17.0	23.9	24	5.0	173.2
PHT08-01(3)	8	14.5	R 1/8	69.8	52.1	8.0	19.1	17.9	14	3.0	62.2
PHT08-02(3)	8	14.5	R 1/4	84.8	55.6	10.1	19.1	21.9	17	4.0	89.2
PHT08-03(3)	8	14.5	R 3/8	86.8	59.4	11.0	19.1	21.9	21	5.0	129.8
PHT08-04(3)	8	14.5	R 1/2	97.7	62.3	14.0	19.1	23.9	24	6.0	178.8
PHT10-01(3)	10	17.5	R 1/8	69.8	56.0	8.0	20.2	17.9	14	3.0	67.2
PHT10-02(3)	10	17.5	R 1/4	84.8	59.5	10.0	20.2	21.9	17	4.0	101.2
PHT10-03(3)	10	17.5	R 3/8	86.8	63.7	11.0	20.2	21.9	21	5.0	137.2
PHT10-04(3)	10	17.5	R 1/2	97.7	67.2	14.0	20.2	23.9	24	6.0	186.2
PHT12-02(3)	12	20.5	R 1/4	84.8	66.0	10.0	22.7	21.9	17	4.0	212.6
PHT12-03(3)	12	20.5	R 3/8	86.8	70.2	11.0	22.7	21.9	21	5.0	154.6
PHT12-04(3)	12	20.5	R 1/2	97.7	74.7	14.0	22.7	23.9	24	6.0	204.6

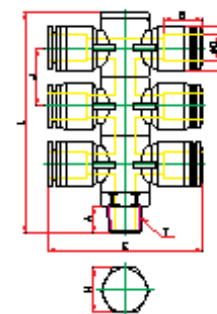

**PHT-G (3) : Racor Instantáneo Cilíndrico "TE" Triple Banjo**

MODELO	D	P	T	L	E	A	B	J	H	Orificio	PESO
PHT04-G01(3)	4	10.5	G 1/8	67.8	46.9	5.0	16.2	17.9	14	3.0	45.8
PHT04-G02(3)	4	10.5	G 1/4	82.8	50.6	6.5	16.2	21.9	17	3.2	69.8
PHT04-G03(3)	4	10.5	G 3/8	83.8	54.4	6.5	16.2	21.9	21	3.2	102.8
PHT06-G01(3)	6	12.5	G 1/8	67.8	48.3	5.0	17.0	17.9	14	3.0	46.2
PHT06-G02(3)	6	12.5	G 1/4	82.8	52.0	6.5	17.0	21.9	17	4.0	70.2
PHT06-G03(3)	6	12.5	G 3/8	83.8	55.8	6.5	17.0	21.9	21	5.0	103.2
PHT06-G04(3)	6	12.5	G 1/2	93.2	58.7	8.0	17.0	23.9	24	5.0	147.2
PHT08-G01(3)	8	14.5	G 1/8	67.8	52.1	5.0	19.1	17.9	14	3.0	47.2
PHT08-G02(3)	8	14.5	G 1/4	82.8	55.6	6.5	19.1	21.9	17	4.0	69.2
PHT08-G03(3)	8	14.5	G 3/8	83.8	59.4	6.5	19.1	21.9	21	5.0	104.2
PHT08-G04(3)	8	14.5	G 1/2	93.2	62.3	8.0	19.1	23.9	24	6.0	148.2
PHT10-G01(3)	10	17.5	G 1/8	67.8	56.0	5.0	20.2	17.9	14	3.0	46.2
PHT10-G02(3)	10	17.5	G 1/4	82.8	59.5	6.5	20.2	21.9	17	4.0	70.2
PHT10-G03(3)	10	17.5	G 3/8	83.8	63.7	6.5	20.2	21.9	21	5.0	103.2
PHT10-G04(3)	10	17.5	G 1/2	93.2	67.2	8.0	20.2	23.9	24	6.0	147.2
PHT12-G02(3)	12	20.5	G 1/4	82.8	66.0	6.5	22.7	21.9	17	4.0	71.6
PHT12-G03(3)	12	20.5	G 3/8	83.8	70.2	6.5	22.7	21.9	21	5.0	104.6
PHT12-G04(3)	12	20.5	G 1/2	93.2	74.7	8.0	22.7	23.9	24	6.0	148.6

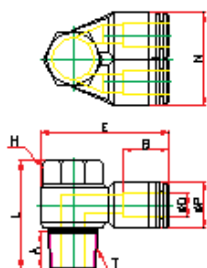

**PA: Racor Instantáneo Cónico Codo "Y" Banjo**

MODELO	D	P	T	L	N	E	A	B	H	Orificio	PESO
PA04-M5	4	10.5	M5*0.8p	18.2	21.0	25.1	3.6	16.3	8	1.5	7.8
PA06-01	6	12.5	R 1/8	25.0	25.0	31.2	8.0	17.6	11	3.0	15.7
PA08-02	8	14.8	R 1/4	28.8	29.6	36.8	10.0	18.7	15	4.5	26.7
PA10-02	10	17.5	R 1/4	28.8	35.0	38.8	10.0	19.6	15	4.5	29.2
PA10-03	10	17.5	R 3/8	32.7	35.0	42.2	11.0	19.6	19	4.3	46.2
PA12-03	12	20.5	R 3/8	32.7	41.0	45.9	11.0	21.9	19	4.3	54.1
PA12-04	12	20.5	R 1/2	39.4	41.0	50.1	14.0	21.9	24	6.0	74.1

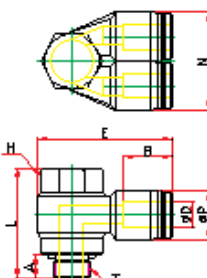

**PA-G: Racor Instantáneo Cilíndrico Codo "Y" Banjo**

MODELO	D	P	T	L	N	E	A	B	H	Orificio	PESO
PA06-G01	6	12.5	G 1/8	23.5	25.0	33.5	4.5	17.6	8	3.0	15.7
PA08-G02	8	14.8	G 1/4	28.0	29.0	38.3	6.0	18.7	12	4.5	25.7
PA10-G02	10	17.5	G 1/4	28.0	35.0	39.5	6.0	19.6	12	4.5	27.2
PA10-G03	10	17.5	G 3/8	32.5	35.0	42.5	6.0	19.6	14	6.0	50.2
PA12-G03	12	20.5	G 3/8	32.5	41.0	44.8	6.0	21.9	14	6.0	53.1
PA12-G04	12	20.5	G 1/2	34.0	41.0	50.3	7.5	21.9	19	8.0	73.1

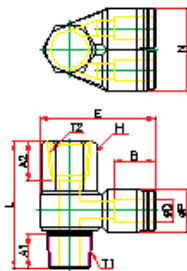

PAF: Racor Instantáneo "Y" Tubo Rosca Cónica Or.

MODELO	D	P	T1	T2	L	N	E	A1	A2	B	H	Orif.	PESO
PAF04-M5	4	10.5	M5*0.8p	M5*0.8p	20.0	21.0	25.1	3.6	7.0	16.3	8	1.5	7.8
PAF06-01	6	12.5	R 1/8	R 1/8	30.2	25.0	31.2	8.0	8.0	17.6	14	3.0	20.7
PAF08-02	8	14.8	R 1/4	R 1/4	35.5	29.6	36.8	10.0	10.0	18.7	17	4.0	31.7
RAF10-02	10	17.5	R 1/4	R 1/4	35.5	35.0	38.8	10.0	10.0	19.6	17	4.0	33.2
PAF10-03	10	17.5	R 3/8	R 3/8	41.2	35.0	42.2	11.0	11.0	19.6	21	5.0	57.2
PAF12-03	12	20.5	R 3/8	R 3/8	41.2	41.0	45.9	11.0	11.0	21.9	21	5.0	67.1
PAF12-04	12	20.5	R 1/2	R 1/2	50.0	41.0	50.1	14.0	14.0	21.9	24	6.0	90.1

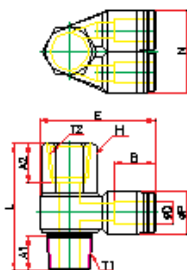

PAF-G: Racor Instantáneo "Y" Tubo Rosca Cilíndrica Or.

MODELO	D	P	T1	T2	L	N	E	A1	A2	B	H	Orif.	PESO
PAF06-G01	6	12.5	R 1/8	R 1/8	30.2	25.0	31.2	8.0	8.0	17.6	14	3.0	20.7
PAF08-G02	8	14.8	R 1/4	R 1/4	35.5	29.6	36.8	10.0	10.0	18.7	17	4.0	31.7
RAF10-G02	10	17.5	R 1/4	R 1/4	35.5	35.0	38.8	10.0	10.0	19.6	17	4.0	33.2
PAF10-G03	10	17.5	R 3/8	R 3/8	41.2	35.0	42.2	11.0	11.0	19.6	21	5.0	57.2
PAF12-G03	12	20.5	R 3/8	R 3/8	41.2	41.0	45.9	11.0	11.0	21.9	21	5.0	67.1
PAF12-G04	12	20.5	R 1/2	R 1/2	50.0	41.0	50.1	14.0	14.0	21.9	24	6.0	90.1

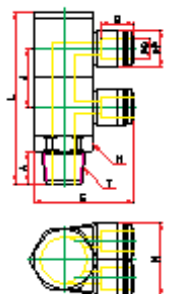

PAT (2) : Racor Instantáneo "Y" Tubo Rosca Cilíndrica Or.

MODELO	D	P	T	L	N	E	A	B	J	H	Orificio	PESO
PAT04-01(2)	4	10.5	R 1/8	51.9	21.0	31.2	8.0	16.2	17.9	14	3.0	35.6
PAT04-02(2)	4	10.5	R 1/4	62.9	21.0	34.6	10.0	16.2	21.9	17	3.2	54.6
PAT06-01(2)	6	12.5	R 1/8	51.9	25.0	31.9	8.0	17.0	17.9	14	3.0	36.4
PAT06-02(2)	6	12.5	R 1/4	62.9	25.0	35.3	10.0	17.0	21.9	17	4.0	55.4
PAT06-03(2)	6	12.5	R 3/8	64.9	25.0	39.1	11.0	17.0	21.9	21	5.0	82.4
PAT08-02(2)	8	14.5	R 1/4	62.9	29.0	37.1	10.0	19.1	21.9	17	4.0	57.4
PAT08-03(2)	8	14.5	R 3/8	64.9	29.0	40.9	11.0	19.1	21.9	21	5.0	82.4
PAT08-04(2)	8	14.5	R 1/2	73.8	29.0	44.6	14.0	19.1	23.9	24	6.0	118.4
PAT10-02(2)	10	17.5	R 1/4	62.9	35.0	39.0	10.0	20.2	21.9	17	4.0	58.4
PAT10-03(2)	10	17.5	R 3/8	64.9	35.0	43.1	11.0	20.2	21.9	21	5.0	83.4
PAT10-04(2)	10	17.5	R 1/2	73.8	35.0	47.0	14.0	20.2	23.9	24	6.0	119.4
PAT12-03(2)	12	20.5	R 3/8	64.9	41.0	46.3	11.0	22.7	21.9	21	5.0	85.2
PAT12-04(2)	12	20.5	R 1/2	73.8	41.0	50.8	14.0	22.7	23.9	24	6.0	121.2

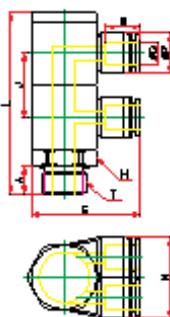

PAT-G (2) : Racor Instantáneo "Y" Tubo Rosca Cilíndrica Or.

MODELO	D	P	T	L	N	E	A	B	J	H	Orif.	PESO
PAT04-01(2)	4	10.5	R 1/8	51.9	21.0	31.2	8.0	16.2	17.9	14	3.0	35.6
PAT04-02(2)	4	10.5	R 1/4	62.9	21.0	34.6	10.0	16.2	21.9	17	3.2	54.6
PAT06-01(2)	6	12.5	R 1/8	51.9	25.0	31.9	8.0	17.0	17.9	14	3.0	36.4
PAT06-02(2)	6	12.5	R 1/4	62.9	25.0	35.3	10.0	17.0	21.9	17	4.0	55.4
PAT06-03(2)	6	12.5	R 3/8	64.9	25.0	39.1	11.0	17.0	21.9	21	5.0	82.4
PAT08-02(2)	8	14.5	R 1/4	62.9	29.0	37.1	10.0	19.1	21.9	17	4.0	57.4
PAT08-03(2)	8	14.5	R 3/8	64.9	29.0	40.9	11.0	19.1	21.9	21	5.0	82.4
PAT08-04(2)	8	14.5	R 1/2	73.8	29.0	44.6	14.0	19.1	23.9	24	6.0	118.4
PAT10-02(2)	10	17.5	R 1/4	62.9	35.0	39.0	10.0	20.2	21.9	17	4.0	58.4
PAT10-03(2)	10	17.5	R 3/8	64.9	35.0	43.1	11.0	20.2	21.9	21	5.0	83.4
PAT10-04(2)	10	17.5	R 1/2	73.8	35.0	47.0	14.0	20.2	23.9	24	6.0	119.4
PAT12-03(2)	12	20.5	R 3/8	64.9	41.0	46.3	11.0	22.7	21.9	21	5.0	85.2
PAT12-04(2)	12	20.5	R 1/2	73.8	41.0	50.8	14.0	22.7	23.9	24	6.0	121.2

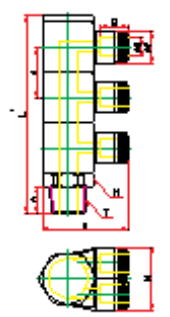

PAT (3) : Racor Instantáneo "Y" Tubo Rosca Cilíndrica Or.

MODELO	D	P	T	L	N	E	A	B	J	H	Orificio	PESO
PAT04-01(3)	4	10.5	R 1/8	69.8	21.0	31.2	8.0	16.2	17.9	14	3.0	36.4
PAT04-02(3)	4	10.5	R 1/4	84.8	21.0	34.6	10.0	16.2	21.9	17	3.2	39.4
PAT06-01(3)	6	12.5	R 1/8	69.8	25.0	31.9	8.0	17.0	17.9	14	3.0	39.1
PAT06-02(3)	6	12.5	R 1/4	84.8	25.0	35.3	10.0	17.0	21.9	17	4.0	42.1
PAT06-03(3)	6	12.5	R 3/8	86.8	25.0	39.1	11.0	17.0	21.9	21	5.0	52.1
PAT08-02(3)	8	14.5	R 1/4	84.8	29.0	37.1	10.0	19.1	21.9	17	4.0	60.1
PAT08-03(3)	8	14.5	R 3/8	86.8	29.0	40.9	11.0	19.1	21.9	21	5.0	65.1
PAT08-04(3)	8	14.5	R 1/2	97.7	29.0	44.6	14.0	19.1	23.9	24	6.0	85.1
PAT10-02(3)	10	17.5	R 1/4	84.8	35.0	39.0	10.0	20.2	21.9	17	4.0	105.6
PAT10-03(3)	10	17.5	R 3/8	86.8	35.0	43.1	11.0	20.2	21.9	21	5.0	112.6
PAT10-04(3)	10	17.5	R 1/2	97.7	35.0	47.0	14.0	20.2	23.9	24	6.0	119.6
PAT12-03(3)	12	20.5	R 3/8	86.8	41.0	46.3	11.0	22.7	21.9	21	5.0	185.6
PAT12-04(3)	12	20.5	R 1/2	97.7	41.0	50.8	14.0	22.7	23.9	24	6.0	193.6



Triple Branch A

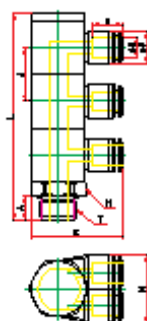

**PAT -G(3): Racor Instantáneo "Y" Triple Doble Banjo Macho Cilíndrico Or.**

MODELO	D	P	T	L	N	E	A	B	J	H	Orificio	PESO
PAT04-G01(3)	4	10.5	G 1/8	67.8	21.0	31.2	5.0	16.2	17.9	14	3.0	44.4
PAT04-G02(3)	4	10.5	G 1/4	82.8	21.0	34.6	6.5	16.2	21.9	17	3.2	68.4
PAT04-G03(3)	4	10.5	G 3/8	83.8	21.0	38.4	6.5	16.2	21.9	21	3.2	101.4
PAT06-G01(3)	6	12.5	G 1/8	67.8	25.0	31.9	5.0	17.0	17.9	14	3.0	45.1
PAT06-G02(3)	6	12.5	G 1/4	82.8	25.0	35.3	6.5	17.0	21.9	17	4.0	69.1
PAT06-G03(3)	6	12.5	G 3/8	83.8	25.0	39.1	6.5	17.0	21.9	21	5.0	102.1
PAT08-G01(3)	8	14.5	G 1/8	67.8	29.0	33.8	5.0	19.1	17.9	14	3.0	46.1
PAT08-G02(3)	8	14.5	G 1/4	82.8	29.0	37.1	6.5	19.1	21.9	17	4.0	70.1
PAT08-G03(3)	8	14.5	G 3/8	83.8	29.0	40.9	6.5	19.1	21.9	21	5.0	103.1
PAT08-G04(3)	8	14.5	G 1/2	93.2	29.0	44.6	8.0	19.1	23.9	24	6.0	147.1
PAT10-G02(3)	10	17.5	G 1/4	82.8	35.0	39.0	6.5	20.2	21.9	17	4.0	70.6
PAT10-G03(3)	10	17.5	G 3/8	83.8	35.0	43.1	6.5	20.2	21.9	21	5.0	103.6
PAT10-G04(3)	10	17.5	G 1/2	93.2	35.0	47.0	8.0	20.2	23.9	24	6.0	147.6
PAT12-G02(3)	12	20.5	G 1/4	82.8	41.0	42.3	6.5	22.7	21.9	17	4.0	72.3
PAT12-G03(3)	12	20.5	G 3/8	83.8	41.0	46.3	6.5	22.7	21.9	21	5.0	105.3
PAT12-G04(3)	12	20.5	G 1/2	93.2	41.0	50.8	8.0	22.7	23.9	24	6.0	149.3



Union Straight

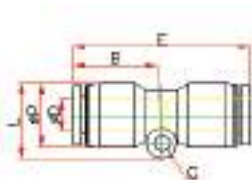

**PUC : Racor Instantáneo Unión**

MODELO	D	P	L	E	C	B	Orificio	PESO
PUC04	4	10.5	12.8	34.6	3.3	16.3	3.0	3.6
PUC06	6	12.5	14.8	36.8	3.3	17.6	4.0	7.4
PUC08	8	14.8	19.9	39.4	4.3	18.7	6.5	8.4
PUC10	10	17.5	20.0	43.2	4.3	19.6	8.0	11.4
PUC12	12	20.5	23.3	47.8	4.3	21.9	10.0	16.2
PUC14	14	23.0	25.5	50.0	4.3	23.7	12.0	21.0
PUC16	16	25.5	25.5	51.1	4.3	24.0	13.0	31.0



Union Elbow

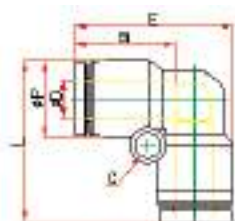

**PUL : Racor Instantáneo Codo Unión**

MODELO	D	P	L	E	C	B	Orificio	PESO
PUL04	4	10.5	24.2	24.2	3.3	16.3	3.0	4.6
PUL06	6	12.5	27.5	27.5	3.3	17.6	5.0	5.4
PUL08	8	14.8	30.7	30.7	4.3	18.7	7.0	8.4
PUL10	10	17.5	34.1	34.1	4.3	19.6	8.0	11.4
PUL12	12	20.5	39.9	39.9	4.3	21.9	10.0	19.2
PUL14	14	23.0	31.9	31.9	4.3	23.7	12.0	24.0
PUL16	16	25.5	46.7	46.7	4.3	24.0	13.0	38.0



Union Tee

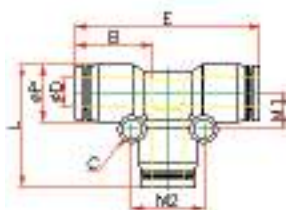

**PUT : Racor Instantáneo "TE" Unión**

MODELO	D	P	L	E	C	B	M1	M2	Orificio	PESO
PUT04	4	10.5	24.2	36.6	3.3	16.3	6.4	12.8	2.6	9.4
PUT06	6	12.5	27.5	41.8	3.3	17.6	7.7	15.4	5.0	10.1
PUT08	8	14.8	30.7	44.9	4.3	18.7	8.9	17.8	6.5	12.1
PUT10	10	17.5	34.1	48.2	4.3	19.6	10.9	21.8	8.0	15.6
PUT12	12	20.5	39.9	56.8	4.3	21.9	12.4	24.8	10.0	26.3
PUT14	14	23.0	31.9	63.8	4.3	23.7	13.7	27.3	12.0	39.0
PUT16	16	25.5	47.2	68.2	4.3	24.0	15.9	31.8	13.0	52.0



Union Y



**PY : Racor Instantáneo "Y" Unión**

MODELO	D	P	L	E	C	B	Orificio	PESO
PY04	4	10.5	37.1	21.0	3.3	16.3	3.0	7.0
PY06	6	12.5	40.2	25.0	3.3	17.6	5.0	9.9
PY08	8	14.8	43.4	29.0	4.3	18.7	5.0	14.1
PY10	10	17.5	47.7	35.0	4.5	19.6	6.0	20.0
PY12	12	20.5	54.1	42.0	4.5	22.8	7.0	31.0
PY16	16	25.5	61.9	51.0	5.3	24.1	11.0	45.9



Reduccion Y

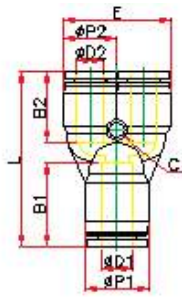

**PW: Racor Instantáneo "Y" Reducción**

MODELO	D1	D2	P1	P2	L	E	C	B	B2	Orificio	PESO
PW0604	6	4	12.5	10.5	37.9	21.0	3.3	17.6	16.3	3.4	7.3
PW0804	8	4	14.8	10.5	39.7	21.0	3.3	18.7	16.3	3.7	9.3
PW0806	8	6	14.8	12.5	41.3	25.0	3.3	18.7	17.6	5.4	10.1
PW1006	10	6	17.5	12.5	43.0	25.0	3.3	19.6	17.6	5.6	12.6
PW1008	10	8	17.5	14.8	43.3	29.6	4.3	19.6	18.7	7.0	14.6
PW1208	12	8	20.5	14.8	47.8	29.6	3.3	21.9	18.7	7.3	16.5
PW1210	12	10	20.5	17.5	46.5	35.0	4.3	21.9	19.6	8.0	21.5
PW1612	16	12	25.5	21.0	57.0	42.0	5.3	24.1	22.8	9.0	33.5



Reduccion Recto

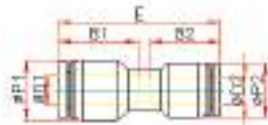

**PG : Racor Instantáneo Reducción Recto**

MODELO	D1	D2	P1	P2	E	B1	B2	Orificio	PESO
PG0604	6	4	12.5	10.5	36.6	17.6	16.3	3.0	5.5
PG0804	8	4	14.8	10.5	38.7	18.7	16.3	3.2	5.5
PG0806	8	6	14.8	12.5	37.6	18.7	17.6	4.0	7.4
PG1006	10	6	17.5	12.5	39.9	19.6	17.6	5.0	7.9
PG1008	10	8	17.5	14.8	41.0	19.6	18.7	6.5	8.9
PG1208	12	8	20.5	14.8	45.9	21.9	18.7	6.5	11.8
PG1210	12	10	20.5	17.5	44.0	21.9	19.6	8.0	13.3
PG1412	14	12	23.0	20.5	49.4	23.7	22.9	10.0	21.0
PG1612	16	12	25.5	20.5	49.7	24.0	22.9	10.0	24.1



Reduccion Central

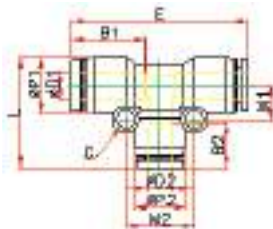

**PTG : Racor Instantáneo "TE" Reducción Central**

MODELO	D1	D2	P1	P2	L	E	C	B1	B2	M1	M2	Orificio	PESO
PTG0604	6	4	12.5	10.5	25.4	41.6	3.3	17.6	16.3	7.9	13.8	3.0	8.2
PTG0804	8	4	14.8	12.5	29.4	46.1	4.3	18.7	17.6	9.7	17.0	5.0	11.1
PTG0806	8	6	14.8	12.5	29.4	46.1	4.3	18.7	17.6	9.7	17.0	5.0	11.1
PTG1006	10	6	17.5	12.5	31.9	49.2	4.3	19.6	17.6	10.9	16.8	5.0	14.1
PTG1008	10	8	17.5	14.8	33.5	49.2	4.3	19.6	18.7	10.9	18.8	6.5	15.1
PTG1208	12	8	20.5	14.8	35.8	56.0	4.3	21.9	18.7	12.4	18.8	7.0	20.9
PTG1210	12	10	20.5	17.5	37.6	56.0	4.3	21.9	19.6	12.4	21.9	8.0	25.4
PTG1610	16	10	25.5	17.5	43.1	60.8	4.3	24.0	19.6	15.9	22.8	8.0	40.2
PTG1612	16	12	25.5	20.5	45.5	63.7	4.3	24.0	21.9	15.9	25.8	10.0	44.1

**PGT : Racor Instantáneo "TE" Reducciones Laterales**

PGT0406	4	6	10.5	12.5	20.3	37.6	4.3	16.4	18.1	7.4	16.8	3.4	6.7
PGT0608	6	8	12.5	14.8	29.4	40.6	4.3	18.1	16.4	8.4	19.1	5.0	9.5
PGT0810	8	10	14.8	17.5	33.5	45.6	4.3	20.3	18.4	9.4	21.4	6.8	13.3
PGT1012	10	12	17.5	20.5	37.6	50.6	4.3	23.1	20.3	10.9	24.8	8.0	20.1



Union Codo Espiga

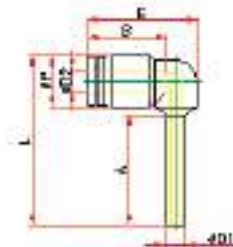

**PLJ : Racor Instantáneo Unión Codo Espiga**

MODELO	D1	D2	P	L	E	A	B	Orificio	PESO
PLJ04	4	4	10.5	28.4	18.8	22.0	16.3	2.0	2.8
PLJ06	6	6	12.5	31.4	20.3	24.0	17.6	4.0	4.7
PLJ08	8	8	14.8	34.3	23.0	26.0	18.7	6.0	5.7
PLJ10	10	10	17.5	37.9	24.2	28.0	19.6	7.0	8.2
PLJ12	12	12	20.5	41.4	28.0	30.0	21.9	9.0	13.1
PLJ16	16	16	25.5	48.5	32.0	35.0	24.0	12.0	34.0
PLJ06-04	6	4	12.5	43.8	18.8	25.0	17.6	2.0	4.0
PLJ08-06	8	6	14.8	47.8	20.3	26.0	18.7	4.0	6.1
PLJ10-08	10	8	17.5	52.4	23.0	28.0	19.6	6.0	7.7
PLJ12-10	12	10	20.5	56.8	24.2	30.0	21.9	7.0	11.2



Reduccion Espiga

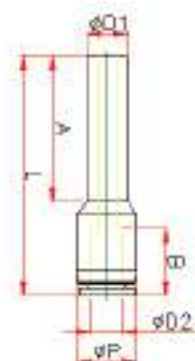

**PGJ: Racor Instantáneo Reducción Espiga**

MODELO	D1	D2	P	L	A	B	Orificio	PESO
PGJ0406	4	6	10.5	41.0	21.7	16.3	3.0	2.8
PGJ0604	6	4	10.5	41.0	21.7	17.6	3.0	2.8
PGJ0804	8	4	10.5	42.0	22.7	16.3	3.0	3.8
PGJ0608	6	8	12.5	44.3	23.7	17.6	4.8	4.7
PGJ0806	8	6	12.5	44.3	23.7	18.7	4.8	4.7
PGJ1006	10	6	12.5	47.3	28.7	17.6	6.0	4.7
PGJ1008	10	8	14.8	49.7	27.7	18.7	6.8	5.7
PGJ1206	12	6	12.5	50.2	33.8	17.6	4.8	5.7
PGJ1208	12	8	14.8	52.5	30.7	18.7	8.0	6.7
PGJ1210	12	10	17.5	56.5	31.2	19.6	8.0	9.2

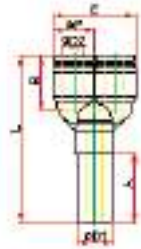

**PYJ : Racor Instantáneo "Y" Unión Espiga**

MODELO	D1	D2	P	L	E	A	B	Orificio	PESO
PYJ04	4	4	10.5	49.5	21.0	22.0	16.8	2.6	6.6
PYJ06	6	6	12.5	54.7	25.0	24.0	17.6	4.0	8.4
PYJ08	8	8	14.5	59.8	29.0	26.0	18.7	5.6	12.4
PYJ10	10	10	17.5	66.1	35.0	28.0	19.6	7.0	18.4
PYJ12	12	12	20.5	71.6	41.0	30.0	21.9	9.0	24.2

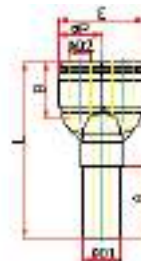

**PWJ : Racor Instantáneo "Y" Reducción Espiga**

MODELO	D1	D2	P	L	E	A	B	Orificio	PESO
PWJ06-04	6	4	10.5	51.5	21.0	24.0	17.6	4.0	6.6
PWJ08-06	8	6	12.5	56.7	25.0	26.0	18.7	5.6	9.4
PWJ10-08	10	8	14.5	61.8	29.0	28.0	19.6	7.0	12.4
PWJ12-10	12	10	17.5	68.1	35.0	30.0	21.9	9.0	19.4



**PIJ : Racor Espiga Unión**

MODELO	D	L	Orificio	PESO
PIJ04	4	37.0	2.5	1.0
PIJ06	6	39.0	3.5	1.0
PIJ08	8	41.0	5.0	2.0
PIJ10	10	44.0	7.0	3.0
PIJ12	12	49.0	8.5	4.0
PIJ16	16	53.2	11.8	6.8

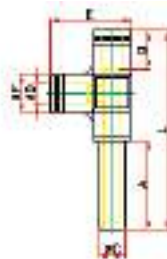

**PSJ : Racor Instantáneo "TE" Espiga Lateral**

MODELO	C	D	P	L	E	A	B	Orificio	PESO
PSJ04	4	4	10.5	58.2	25.1	24.0	16.8	2.6	6.6
PSJ06	6	6	12.5	62.6	28.1	25.0	17.6	4.0	9.4
PSJ08	8	8	14.8	67.2	30.9	26.0	18.7	5.6	12.4
PSJ10	10	10	17.5	72.9	34.6	28.0	19.6	7.0	17.4
PSJ12	12	12	20.5	81.7	40.3	30.0	21.9	9.0	25.8
PSJ06-04	6	4	10.5	59.2	25.1	25.0	16.8	2.6	6.6
PSJ08-06	8	6	12.5	63.6	28.1	26.0	17.6	4.0	9.4
PSJ10-08	10	8	14.8	69.5	30.9	28.0	18.7	5.6	13.4
PSJ12-10	12	10	17.5	75.1	34.6	30.0	19.6	7.5	27.4

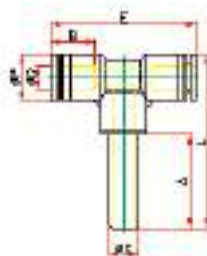

**PTJ : Racor Instantáneo "TE" Espiga Central**

MODELO	C	D	P	L	E	A	B	Orificio	PESO
PTJ04	4	4	10.5	37.5	37.6	24.0	16.8	2.6	5.6
PTJ06	6	6	12.5	40.5	41.0	25.0	17.6	4.0	8.4
PTJ08	8	8	14.8	43.0	44.4	26.0	18.7	5.6	11.4
PTJ10	10	10	17.5	45.8	47.2	28.0	19.6	7.0	17.4
PTJ12	12	12	20.5	50.9	54.8	30.0	21.9	9.0	23.2
PTJ06-04	6	4	10.5	38.5	37.6	25.0	16.8	2.6	6.6
PTJ08-06	8	6	12.5	41.5	41.0	26.0	17.6	4.0	9.4
PTJ10-08	10	8	14.8	45.3	44.4	28.0	18.7	5.6	12.4
PTJ12-10	12	10	17.5	48.0	47.2	30.0	19.6	7.5	17.4

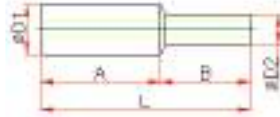

**PIG : Racor Espiga Reducción**

MODELO	D1	D2	L	A	B	Orificio	PESO
PIG0604	6	4	38.0	20.0	18.0	2.0	1.0
PIG0804	8	4	40.0	21.0	19.0	2.0	1.0
PIG0806	8	6	41.5	21.0	20.5	3.5	2.0
PIG1006	10	6	42.5	22.0	20.5	3.5	2.0
PIG1008	10	8	43.5	22.0	21.5	5.0	3.0
PIG1208	12	8	45.5	24.0	21.5	5.0	3.0
PIG1210	12	10	46.5	24.0	22.5	6.8	3.0
PIG1612	16	12	52.0	27.0	25.0	8.5	6.0

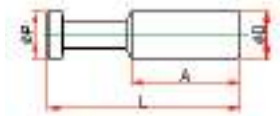

**PP : Racor Tapón Macho**

MODELO	D	P	L	A	PESO
PP04	4	4	30.0	17.7	1.0
PP06	6	6	34.0	19.4	1.0
PP08	8	8	38.0	21.2	1.0
PP10	10	10	42.0	23.8	2.0
PP12	12	12	46.0	29.5	3.0
PP16	16	16	50.0	30.0	12.0

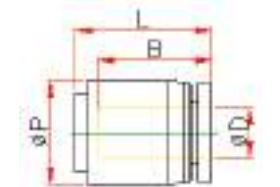

**PPF : Racor Instantáneo Tapón Hembra**

MODELO	D	P	L	B	PESO
PPF04	4	10.5	18.0	16.8	2.8
PPF06	6	12.5	19.0	17.6	3.8
PPF08	8	14.5	21.0	18.7	3.7
PPF10	10	17.5	23.0	19.6	5.5
PPF12	12	20.5	25.0	21.9	9.3
PPF16	16	25.5	27.5	24.0	17.0

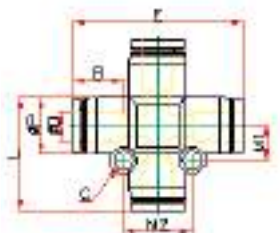

**PZA : Racor Instantáneo Cruz Unión**

MODELO	D	P	L	E	C	B	M1	M2	Orificio	PESO
PZA04	4	10.5	37.9	36.6	3.3	16.8	6.4	12.8	2.6	8.2
PZA06	6	12.5	42.5	41.8	4.3	17.6	7.5	14.9	4.5	10.8
PZA08	8	14.8	46.8	44.9	4.3	18.7	9.1	18.2	6.0	5.8
PZA10	10	17.5	50.5	48.2	4.3	19.6	10.2	20.3	7.4	20.8
PZA12	12	20.5	57.2	54.8	4.3	21.9	11.9	23.7	9.0	33.4

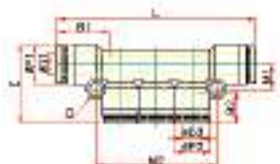

**PKG : Racor Instantáneo Distribuidor "TE" 3x2 Reducción**

MODELO	D1	D2	P1	P2	L	E	C	B1	B2	M1	M2	Orificio	PESO
PKG0604	6	4	12.5	10.5	63.7	24.2	3.3	17.6	16.3	7.6	34.0	3.0	12.8
PKG0804	8	4	14.8	10.5	65.7	28.5	4.3	18.7	16.3	9.2	34.8	3.0	14.8
PKG0806	8	6	14.8	12.5	71.7	30.0	4.3	18.7	17.6	9.3	41.1	4.0	17.5
PKG1006	10	6	17.5	12.5	78.1	32.0	4.3	19.6	17.6	9.5	41.7	4.0	22.5
PKG1008	10	8	17.5	14.8	83.4	34.5	4.3	19.6	18.7	8.5	47.0	6.5	26.5

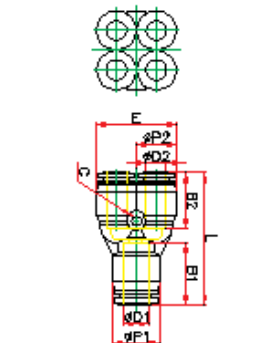

**PXG : Racor Instantáneo Distribuidor X 4 Salidas Reducción**

MODELO	D1	D2	P	L	E	A	B	Orificio	PESO		
PXG0604	6	4	12.5	10.5	37.2	21.0	3.3	17.0	15.7	2.0	12.8
PXG0806	8	6	14.6	12.5	40.6	25.0	3.3	19.1	17.0	3.5	17.5



Plug-in Reducer Double Y

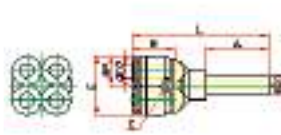

**PXJ : Racor Instantáneo "X" Distribución Red Espiga 4 x 2**

MODELO	D1	D2	P	L	E	C	A	B	Orificio	PESO
PXJ0604	6	4	12.5	43.6	21.0	3.3	17.0	15.7	2.0	12.8
PXJ0806	8	6	14.6	48.0	25.0	3.3	19.1	17.0	3.5	17.5



Plug-in Reducer Triple Branch

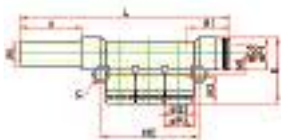

**PKJ : Racor Instantáneo Derivación Espiga 3 x 2 Reducción**

MODELO	D1	D2	J	P1	P2	L	E	C	A	B1	B2	M1	M2	Orificio	PESO
PKJ0604	6	4	6	12.5	10.5	84.3	24.2	3.3	25.0	17.6	16.3	7.6	34.0	3.0	14.1
PKJ0804	8	4	8	14.8	10.5	89.5	28.5	4.3	28.5	18.7	16.3	9.2	34.8	3.0	16.1
PKJ0806	8	6	8	14.8	12.5	95.5	34.0	4.3	28.5	18.7	17.6	9.3	41.1	4.0	17.8
PKJ1006	10	6	10	17.5	12.5	103.2	31.3	4.3	31.0	19.6	17.6	9.5	41.7	4.0	23.5
PKJ1008	10	8	10	17.5	14.8	109.7	34.5	4.3	31.0	19.6	18.7	8.5	47.0	6.5	28.3

**GAMA DE RACORES "COMPACT":**  
Para máquinas y usos de neumática miniaturizados.



Male Straight

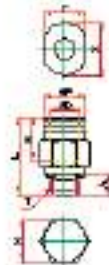

**PC-C : Racor Instantáneo Compacto Cónico Recto**

MODELO	D	P	T	L	A	B	H	X	Y	Orificio	PESO
PC-C 03-M3	3	7.0	M3*0.5p	17.1	4.0	11.1	7	9.2	7.2	1.5	1.0
PC-C 03-M5	3	7.2	M5*0.8p	17.7	4.6	11.1	8	9.2	7.2	2.0	3.0
PC-C 03-M6	3	7.2	M6*1.0p	18.2	5.1	11.1	8	9.2	7.2	2.0	3.0
PC-C 03-01	3	7.2	R 1/8	14.5	8.0	11.3	10	9.2	7.2	2.0	4.0
PC-C 04-M3	4	8.0	M3*0.5p	17.7	4.0	11.6	8	10.4	8.2	1.5	3.0
PC-C 04-M5	4	8.0	M5*0.8p	18.2	4.6	11.6	8	10.4	8.2	2.4	3.0
PC-C 04-M6	4	8.0	M6*1.0p	18.8	5.1	11.6	8	10.4	8.2	3.0	3.0
PC-C 04-01	4	10.0	R 1/8	17.3	8.0	11.6	10	10.4	8.2	3.0	6.0
PC-C 06-M5	6	10.0	M5*0.8p	19.4	4.6	12.8	10	12.4	10.2	2.4	4.0
PC-C 06-M6	6	10.0	M6*1.0p	19.9	5.1	12.8	10	12.4	10.2	2.4	4.0
PC-C 06-01	6	10.0	R 1/8	19.6	8.0	12.8	10	12.4	10.2	5.0	6.0



Female Straight

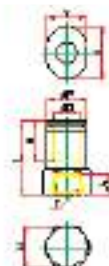

**PCF-C : Racor Instantáneo Compacto Cónico Recto Hembra**

MODELO	D	P	T	L	A	B	H	X	Y	Orificio	PESO
PCF-C 03-M3	3	7.5	M3*0.5p	17.3	4.0	11.1	8	9.2	7.2	2.5	4.0
PCF-C 03-M5	3	7.5	M5*0.8p	18.8	6.0	11.1	8	9.2	7.2	2.5	4.0
PCF-C 03-M6	3	7.5	M6*1.0p	18.8	6.0	11.1	8	9.2	7.2	2.5	5.0
PCF-C 04-M3	4	8.0	M4*0.5p	18.2	4.0	11.6	8	10.4	8.2	2.5	4.0
PCF-C 04-M5	4	8.0	M5*0.8p	19.7	6.0	11.6	8	10.4	8.2	3.0	4.0
PCF-C 04-M6	4	8.0	M6*1.0p	19.7	6.0	11.6	8	10.4	8.2	3.0	5.0
PCF-C 04-01	4	8.0	R 1/8	23.2	8.5	11.6	12	10.4	8.2	3.0	7.0
PCF-C 06-M5	6	10.0	M5*0.8p	21.4	6.0	12.8	10	12.4	10.2	4.0	5.0
PCF-C 06-M6	6	10.0	M6*1.0p	21.4	6.0	12.8	10	12.4	10.2	4.0	5.0
PCF-C 06-01	6	10.0	R 1/8	25.4	8.5	12.8	12	12.4	10.2	4.0	7.0



Round-to-straight

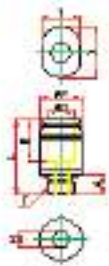

**POC-C : Racor Instantáneo Compacto Cónico Recto Circular**

MODELO	D	P	T	L	A	B	H	X	Y	Orificio	PESO
POC-C 03-M3	3	7.0	M3*0.5p	17.1	4.0	11.1	1.5	9.2	7.2	1.5	2.0
POC-C 03-M5	3	7.0	M5*0.8p	17.7	4.6	11.1	2.0	9.2	7.2	2.0	4.0
POC-C 03-M6	3	8.0	M6*1.0p	18.2	5.1	11.1	2.0	9.2	7.2	2.0	4.0
POC-C 04-M3	4	8.0	M3*0.5p	17.7	4.0	11.6	1.5	10.4	8.2	1.5	3.0
POC-C 04-M5	4	8.0	M5*0.8p	18.2	4.6	11.6	2.5	10.4	8.2	2.5	4.0
POC-C 04-M6	4	8.0	M6*1.0p	18.8	5.1	11.6	3.0	10.4	8.2	3.0	4.0
POC-C 04-01	4	10.0	R 1/8	17.3	8.0	11.6	3.0	10.4	8.2	3.0	6.0
POC-C 06-M5	6	10.0	M5*0.8p	19.4	4.6	12.8	2.5	12.4	10.2	2.5	4.0
POC-C 06-M6	6	10.0	M6*1.0p	19.9	5.1	12.8	3.0	12.4	10.2	3.0	4.0
POC-C 06-01	6	10.0	R 1/8	19.6	8.0	12.8	4.0	12.4	10.2	4.0	5.0

**PMM-C : Racor Instantáneo Pasamuro Compacto**

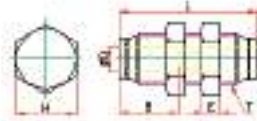

MODELO	D	T	L	E	B	H	Orificio	PESO
PMM-C 03	3	M8*0.75P	23.6	2	11.3	10	2.0	8.0
PMM-C 04	4	M10*1.0P	24.5	3.5	11.8	12	3.0	10.2
PMM-C 06	6	M12*1.0P	27.3	4	12.9	14	5.0	14.2

**PL-C : Racor Instantáneo Compacto Codo**

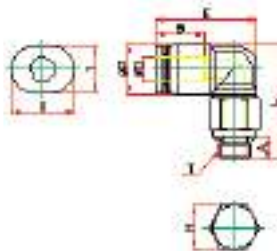

MODELO	D	P	T	L	E	A	B	H	X	Y	Orificio	PESO
PL-C 03-M3	3	7.6	M3*0.5p	18.5	17.2	3.0	11.1	8	9.2	7.2	1.5	2.0
PL-C 03-M5	3	7.6	M5*0.8p	19.1	17.2	3.6	11.1	8	9.2	7.2	2.4	3.0
PL-C 03-M6	3	7.6	M6*1.0p	19.6	17.2	4.1	11.1	8	9.2	7.2	2.4	3.0
PL-C 04-M3	4	8.7	M3*0.5p	19.6	18.2	3.0	11.6	8	10.4	8.2	1.5	3.0
PL-C 04-M5	4	8.7	M5*0.8p	20.2	18.2	3.6	11.6	8	10.4	8.2	2.5	3.0
PL-C 04-M6	4	8.7	M6*1.0p	20.7	18.2	4.1	11.6	8	10.4	8.2	2.5	4.0
PL-C 04-01	4	8.7	R 1/8	20.7	18.2	8.0	11.6	10	10.4	8.2	2.5	10.0
PL-C 06-M5	6	10.8	M5*0.8p	22.3	19.4	3.6	12.8	8	12.4	10.2	2.5	4.0
PL-C 06-M6	6	10.8	M6*1.0p	22.8	19.4	4.1	12.8	8	12.4	10.2	2.5	4.0
PL-C 06-01	6	10.8	R 1/8	22.8	19.4	8.0	12.8	10	12.4	10.2	2.5	7.0

**PLL-C : Racor Instantáneo Compacto Codo Prolongado**

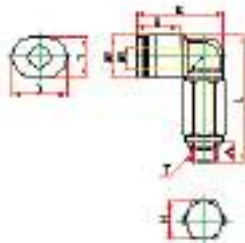

MODELO	D	P	T	L	E	A	B	H	X	Y	Orificio	PESO
PLL-C 03-M3	3	7.6	M3*0.5p	18.5	17.2	3.0	11.1	8	9.2	7.2	1.5	2.0
PLL-C 03-M5	3	7.6	M5*0.8p	19.1	17.2	3.6	11.1	8	9.2	7.2	2.4	3.0
PLL-C 03-M6	3	7.6	M6*1.0p	19.6	17.2	4.1	11.1	8	9.2	7.2	2.4	3.0
PLL-C 04-M3	4	8.7	M3*0.5p	19.6	18.2	3.0	11.6	8	10.4	8.2	1.5	3.0
PLL-C 04-M5	4	8.7	M5*0.8p	20.2	18.2	3.6	11.6	8	10.4	8.2	2.5	3.0
PLL-C 04-M6	4	8.7	M6*1.0p	20.7	18.2	4.1	11.6	8	10.4	8.2	2.5	4.0
PLL-C 04-01	4	8.7	R 1/8	20.7	18.2	8.0	11.6	10	10.4	8.2	2.5	5.0
PLL-C 06-M5	6	10.8	M5*0.8p	22.3	19.4	3.6	12.8	8	12.4	10.2	2.5	4.0
PLL-C 06-M6	6	10.8	M6*1.0p	22.8	19.4	4.1	12.8	8	12.4	10.2	2.5	4.0
PLL-C 06-01	6	10.8	R 1/8	22.8	19.4	8.0	12.8	10	12.4	10.2	2.5	7.0

**PT-C : Racor Instantáneo Compacto "TE" Central**

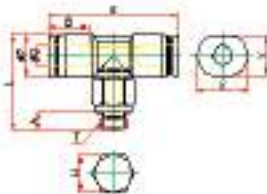

MODELO	D	P	T	L	E	A	B	H	X	Y	Orificio	PESO
PT-C 03-M3	3	7.6	M3*0.5p	18.5	26.6	3.0	11.1	8	9.2	7.2	1.5	2.0
PT-C 03-M5	3	7.6	M5*0.8p	19.1	26.6	3.6	11.1	8	9.2	7.2	2.4	3.0
PT-C 03-M6	3	7.6	M6*1.0p	19.6	26.6	4.1	11.1	8	9.2	7.2	2.4	4.0
PT-C 04-M3	4	8.7	M3*0.5p	19.6	28.6	3.0	11.6	8	10.4	8.2	1.5	4.0
PT-C 04-M5	4	8.7	M5*0.8p	20.2	28.6	3.6	11.6	8	10.4	8.2	2.5	4.0
PT-C 04-M6	4	8.7	M6*1.0p	20.7	28.6	4.1	11.6	8	10.4	8.2	3.0	5.0
PT-C 04-01	4	8.7	R 1/8	20.7	28.6	8.0	11.6	10	10.4	8.2	3.0	7.0
PT-C 06-M5	6	10.8	M5*0.8p	22.3	31.0	3.6	12.8	8	12.4	10.2	2.5	6.0
PT-C 06-M6	6	10.8	M6*1.0p	22.8	31.0	4.1	12.8	8	12.4	10.2	3.0	6.0
PT-C 06-01	6	10.8	R 1/8	22.8	31.0	8.0	12.8	10	12.4	10.2	3.0	8.0

**PST-C : Racor Instantáneo Compacto "TE" Lateral**

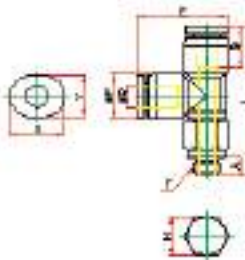

MODELO	D	P	T	L	E	A	B	H	X	Y	Orificio	PESO
PST-C 03-M3	3	7.6	M3*0.5p	18.5	26.6	3.0	11.1	8	9.2	7.2	1.5	2.0
PST-C 03-M5	3	7.6	M5*0.8p	19.1	26.6	3.6	11.1	8	9.2	7.2	2.4	3.0
PST-C 03-M6	3	7.6	M6*1.0p	19.6	26.6	4.1	11.1	8	9.2	7.2	2.4	4.0
PST-C 04-M3	4	8.7	M3*0.5p	19.6	28.6	3.0	11.6	8	10.4	8.2	1.5	4.0
PST-C 04-M5	4	8.7	M5*0.8p	20.2	28.6	3.6	11.6	8	10.4	8.2	2.5	4.0
PST-C 04-M6	4	8.7	M6*1.0p	20.7	28.6	4.1	11.6	8	10.4	8.2	3.0	5.0
PST-C 04-01	4	8.7	R 1/8	20.7	28.6	8.0	11.6	10	10.4	8.2	3.0	7.0
PST-C 06-M5	6	10.8	M5*0.8p	22.3	31.0	3.6	12.8	8	12.4	10.2	2.5	6.0
PST-C 06-M6	6	10.8	M6*1.0p	22.8	31.0	4.1	12.8	8	12.4	10.2	3.0	6.0
PST-C 06-01	6	10.8	R 1/8	22.8	31.0	8.0	12.8	10	12.4	10.2	3.0	8.0

**PUC-C : Racor Instantáneo Unión Compacto**

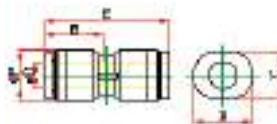

MODELO	D	P	E	B	X	Y	Orificio	PESO
PUC-C 03	3	7.6	23.2	11.1	9.2	7.2	2.4	1.0
PUC-C 04	4	8.5	24.5	11.6	10.4	8.2	3.0	2.0
PUC-C 06	6	10.7	26.6	12.8	12.4	10.2	4.0	3.0

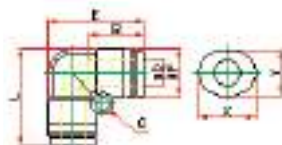

**PUL-C : Racor Instantáneo Codo Compacto**

MODELO	D	P	L	E	C	B	X	Y	Orificio	PESO
PUL-C 03	3	7.6	17.1	17.1	3.2	11.1	9.2	7.2	2.4	1.0
PUL-C 04	4	8.5	18.5	18.5	3.2	11.6	10.4	8.2	3.0	2.0
PUL-C 06	6	10.7	21.8	21.8	3.2	12.8	12.4	10.2	4.0	4.0

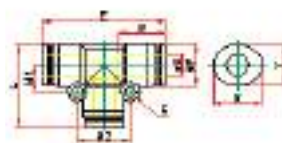

**PUT-C : Racor Instantáneo "TE" Compacto**

MODELO	D	P	L	E	C	B	M1	M2	X	Y	Orificio	PESO
PUT-C 03	3	7.6	17.1	26.6	3.2	11.1	5.4	10.7	9.2	7.2	2.4	2.0
PUT-C 04	4	8.5	18.5	28.6	3.2	11.6	5.8	11.6	10.4	8.2	3.0	3.0
PUT-C 06	6	10.7	21.8	33.0	3.2	12.8	6.9	13.8	12.4	10.2	4.0	5.0



**PG-C : Racor Instantáneo Reducción Compacto**

MODELO	D1	D2	P1	P2	E	B1	B2	X1	Y1	X2	Y2	Orificio	PESO
PG-C 04-03	4	3	8.5	7.6	23.8	11.6	11.1	10.4	8.2	9.2	7.2	2.4	2.0
PG-C 06-03	6	3	10.7	7.6	24.2	12.8	11.1	12.4	10.2	9.2	7.2	2.5	2.0
PG-C 06-04	6	4	10.7	8.5	26.3	12.8	11.6	12.4	10.2	10.4	8.2	3.0	3.0



**PY-C : Racor Instantáneo Unión "Y" Compacto**

MODELO	D	P	L	E	C	B	X	Y	Orificio	PESO
PY-C 03	3	7.6	26.8	15.2	3.2	11.1	9.2	7.2	2.4	4.0
PY-C 04	4	8.7	28.0	17.4	3.2	11.8	10.4	8.2	3.0	3.0
PY-C 06	6	10.8	30.8	21.6	3.2	12.9	12.4	10.2	4.0	5.0

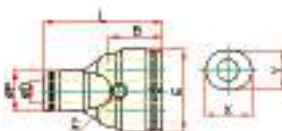

**PW-C : Racor Instantáneo Reducción "Y" Compacto**

MODELO	D1	D2	P1	P2	L	E	C	B1	B2	Orificio	PESO
PW-C 04-03	4	3	8.2	7.6	27.5	15.2	3.2	11.8	11.3	2.0	4.0
PW-C 06-03	6	3	10.8	7.6	28.7	15.2	3.2	12.9	11.3	2.4	4.0
PW-C 06-04	6	4	10.8	8.7	29.2	17.4	3.2	12.9	11.8	3.0	4.0

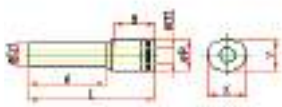

**PGJ-C : Racor Instantáneo Compacto Reducción Espiga Recto**

MODELO	D1	D2	P	L	A	B	X	Y	Orificio	PESO
PGJ-C 04-03	4	3	7.6	30.4	18.0	11.3	9.2	7.2	2.4	1.0
PGJ-C 06-03	6	3	7.6	32.0	21.6	11.3	9.2	7.2	2.4	2.0
PGJ-C 06-04	6	4	8.4	33.7	21.8	11.8	10.4	8.2	3.0	2.0

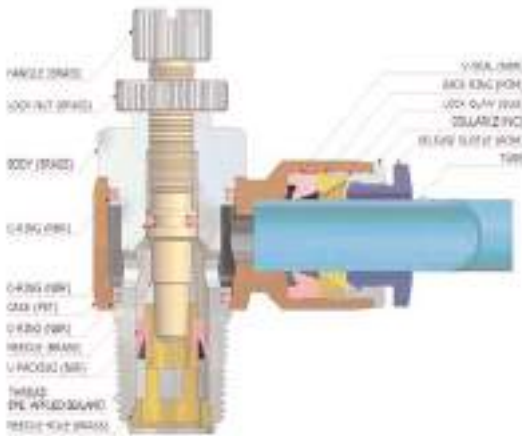

Meter-Out method control



Meter-In method control



REGULADORES DE CAUDAL CDC:

REGULADORES DE CAUDAL: Precisa regulación para un óptimo control del flujo de aire.  
Compactos y precisos, conforman un amplio ratio de regulación.

Bidireccionales: -OUT códigos normales compulsador azul, el aire se regula solamente de rosca a tubo.  
Modelos finalizados en -IN (bajo pedido regulación de tubo a rosca con pulsador rojo)

Aplicaciones de aire comprimido (No de gas o líquidos)

Presión de servicio Rango 0~150PSI  
0~9.9Kgf/cm<sup>2</sup>(0~990KPa)  
Vacío -29.5in Hg -750mmHg(-750Torr)  
Temperatura de servicio: 32~140°F 0~60°C

NSC : Regulador de Caudal Instantáneo Cónico Codo Orientable

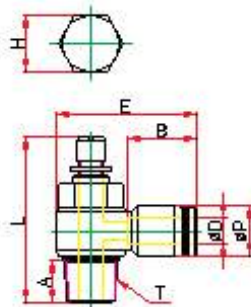

MODELO	D	P	T	L/min	L/max	E	A	B	H	PESO
NSC03-M5	3	7.8	M5*0.8p	27.2	30.2	21.4	3.6	11.1	8	7.0
NSC04-M5	4	10.5	M5*0.8p	27.2	30.2	25.1	3.6	16.3	8	7.8
NSC04-01	4	10.5	R 1/8	34.9	40.1	30.5	8.0	16.3	11	17.8
NSC04-02	4	10.5	R 1/4	40.0	45.7	34.5	10.0	16.3	15	33.8
NSC06-M5	6	12.5	M5*0.8p	27.2	30.2	27.8	3.6	17.6	8	8.7
NSC06-01	6	12.5	R 1/8	34.9	40.1	31.2	8.0	17.6	11	17.7
NSC06-02	6	12.5	R 1/4	40.0	45.7	35.0	10.0	17.6	15	33.7
NSC06-03	6	12.5	R 3/8	46.7	55.0	38.7	11.0	17.6	19	63.7
NSC06-04	6	12.5	R 1/2	53.0	60.2	44.9	14.0	17.6	24	102.7
NSC08-01	8	14.5	R 1/8	34.9	40.1	33.0	8.0	18.7	11	19.7
NSC08-02	8	14.5	R 1/4	40.0	45.7	36.8	10.0	18.7	15	34.7
NSC08-03	8	14.5	R 3/8	46.7	55.0	40.1	11.0	18.7	19	64.7
NSC08-04	8	14.5	R 1/2	53.0	60.2	45.8	14.0	18.7	24	103.7
NSC10-01	10	17.5	R 1/8	34.9	40.1	35.9	8.0	19.6	11	21.2
NSC10-02	10	17.5	R 1/4	40.0	45.7	38.8	10.0	19.6	15	37.2
NSC10-03	10	17.5	R 3/8	46.7	55.0	42.2	11.0	19.6	19	67.2
NSC10-04	10	17.5	R 1/2	53.0	60.2	47.5	14.0	19.6	24	104.2
NSC12-02	12	20.5	R 1/4	40.0	45.7	40.8	10.0	21.9	15	40.1
NSC12-03	12	20.5	R 3/8	46.7	55.0	45.9	11.0	21.9	19	70.1
NSC12-04	12	20.5	R 1/2	53.0	60.2	50.1	14.0	21.9	24	107.1

NSC-G : Regulador de Caudal Instantáneo Cilíndrico Codo Orientable

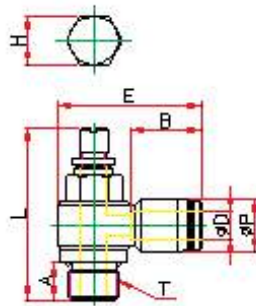

MODELO	D	P	T	L/min	L/max	E	A	B	H	PESO
NSC04-G01	4	10.5	G 1/8	34.9	40.1	30.5	6.0	16.3	8	18.8
NSC04-G02	4	10.5	G 1/4	40.0	45.7	34.5	8.0	16.3	12	33.8
NSC06-G01	6	12.5	G 1/8	34.9	40.1	31.2	6.0	17.6	8	18.7
NSC06-G02	6	12.5	G 1/4	40.0	45.7	35.0	8.0	17.6	12	34.7
NSC06-G03	6	12.5	G 3/8	46.7	55.0	38.7	8.0	17.6	14	61.7
NSC06-G04	6	12.5	G 1/2	53.0	60.2	44.9	9.0	17.6	19	95.7
NSC08-G01	8	14.5	G 1/8	34.9	40.1	33.0	6.0	18.7	8	19.7
NSC08-G02	8	14.5	G 1/4	40.0	45.7	36.8	8.0	18.7	12	35.7
NSC08-G03	8	14.5	G 3/8	46.7	55.0	40.1	8.0	18.7	14	62.7
NSC08-G04	8	14.5	G 1/2	53.0	60.2	45.8	9.0	18.7	19	96.7
NSC10-G01	10	17.5	G 1/8	34.9	40.1	35.9	6.0	19.6	8	21.2
NSC10-G02	10	17.5	G 1/4	40.0	45.7	38.8	8.0	19.6	12	37.2
NSC10-G03	10	17.5	G 3/8	46.7	55.0	42.2	8.0	19.6	14	64.2
NSC10-G04	10	17.5	G 1/2	53.0	60.2	47.5	9.0	19.6	19	97.2
NSC12-G02	12	20.5	G 1/4	40.0	45.7	40.8	8.0	21.9	12	38.1
NSC12-G03	12	20.5	G 3/8	46.7	55.0	45.9	8.0	21.9	14	70.1
NSC12-G04	12	20.5	G 1/2	53.0	60.2	50.1	9.0	21.9	19	104.1

NSC (D) : Regulador de Caudal Tornillo Oculto Cónico Inst. Codo Orient.

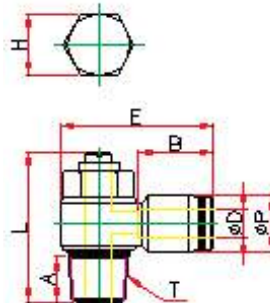

MODELO	D	P	T	L/min	L/max	E	A	B	H	PESO
NSC04-M5(D)	4	10.5	M5*0.8p	19.8	23.1	25.1	3.6	16.3	8	6.8
NSC04-01(D)	4	10.5	R 1/8	26.6	30.4	30.5	8.0	16.3	11	15.8
NSC04-02(D)	4	10.5	R 1/4	31.3	36.3	34.5	10.0	16.3	15	29.8
NSC06-M5(D)	6	12.5	M5*0.8p	19.8	23.1	27.8	3.6	17.6	8	7.7
NSC06-01(D)	6	12.5	R 1/8	26.6	30.4	31.2	8.0	17.6	11	15.7
NSC06-02(D)	6	12.5	R 1/4	31.3	36.3	35.0	10.0	17.6	15	29.7
NSC08-01(D)	8	14.5	R 1/8	26.6	30.4	33.0	8.0	18.7	11	16.7
NSC08-02(D)	8	14.5	R 1/4	31.3	36.3	36.8	10.0	18.7	15	30.7
NSC08-03(D)	8	14.5	R 3/8	36.9	42.4	40.1	11.0	18.7	19	53.7
NSC10-02(D)	10	17.5	R 1/4	31.3	36.3	38.8	10.0	19.6	15	33.2
NSC10-03(D)	10	17.5	R 3/8	36.9	42.4	42.2	11.0	19.6	19	56.2
NSC10-04(D)	10	17.5	R 1/2	43.0	49.5	47.5	14.0	19.6	24	91.2
NSC12-03(D)	12	20.5	R 3/8	36.9	42.4	45.9	11.0	21.9	19	59.1
NSC12-04(D)	12	20.5	R 1/2	43.0	49.5	50.1	14.0	21.9	24	94.1



**NSCF : Regulador de Caudal Banjo rosca Hembra cilíndrica Codo Or.**

MODELO	P	T	L/min	L/max	E1	E2	H1	H2	A	B	PESO
NSCF01	14.5	G 1/8	35.5	40.7	18.2	7.3	12	15	7,6	10	30
NSCF02	18.0	G 1/4	40.3	46.6	26.5	9.5	15	19	10,6	13	60
NSCF03	23.0	G 3/8	46.9	54.9	30.8	11.6	19	24	12,6	15	107
NSCF04	26.5	G 1/2	54.0	60.1	38.7	14.0	24	28	14,5	19	170

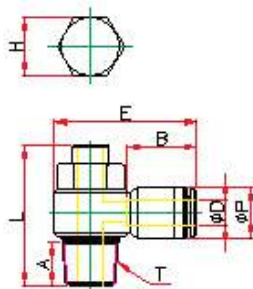

**NSC (DC) : Regulador de Caudal Tornillo Oculto Cónico Inst. Codo Orient**

MODELO	D	P	T	L	E	A	B	H	PESO
NSC04-01(DC)	4	10.5	G 1/8	31.6	30.5	6.0	16.3	8	16.8
NSC04-02(DC)	4	10.5	G 1/4	37.0	34.5	8.0	16.3	12	29.8
NSC06-01(DC)	6	12.5	G 1/8	31.6	31.2	6.0	17.6	8	16.7
NSC06-02(DC)	6	12.5	G 1/4	37.0	35.0	8.0	17.6	12	30.7
NSC06-03(DC)	6	12.5	G 3/8	43.3	38.7	8.0	17.6	14	55.7
NSC06-04(DC)	6	12.5	G 1/2	50.2	45.8	9.0	17.6	19	89.7
NSC08-01(DC)	8	14.5	G 1/8	31.6	33.0	6.0	18.7	8	17.7
NSC08-02(DC)	8	14.5	G 1/4	37.0	36.8	8.0	18.7	12	31.7
NSC08-03(DC)	8	14.5	G 3/8	43.3	40.1	8.0	18.7	14	56.7
NSC08-04(DC)	8	14.5	G 1/2	50.2	45.8	9.0	18.7	19	91.7
NSC10-01(DC)	10	17.5	G 1/8	31.6	33.0	6.0	19.6	8	19.2
NSC10-02(DC)	10	17.5	G 1/4	37.0	38.8	8.0	19.6	12	33.2
NSC10-03(DC)	10	17.5	G 3/8	43.3	42.2	8.0	19.6	14	58.2
NSC10-04(DC)	10	17.5	G 1/2	50.2	47.5	9.0	19.6	19	92.2
NSC12-02(DC)	12	20.5	G 1/4	37.0	40.8	8.0	21.9	12	34.1
NSC12-03(DC)	12	20.5	G 3/8	43.3	45.9	8.0	21.9	14	64.1
NSC12-04(DC)	12	20.5	G 1/2	50.2	50.1	9.0	21.9	19	97.1

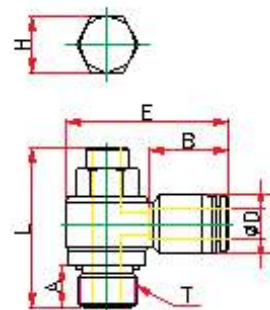

**NSC-G (DC) : Regulador Caudal Tornillo Oculto Cilíndrico Inst Codo Orient**

MODELO	D	P	T	L	E	A	B	H	PESO
NSC04-G01(DC)	4	10.5	G 1/8	31.6	30.5	6.0	16.3	8	16.8
NSC04-G02(DC)	4	10.5	G 1/4	37.0	34.5	8.0	16.3	12	29.8
NSC06-G01(DC)	6	12.5	G 1/8	31.6	31.2	6.0	17.6	8	16.7
NSC06-G02(DC)	6	12.5	G 1/4	37.0	35.0	8.0	17.6	12	30.7
NSC06-G03(DC)	6	12.5	G 3/8	43.3	38.7	8.0	17.6	14	55.7
NSC06-G04(DC)	6	12.5	G 1/2	50.2	45.8	9.0	17.6	19	89.7
NSC08-G01(DC)	8	14.5	G 1/8	31.6	33.0	6.0	18.7	8	17.7
NSC08-G02(DC)	8	14.5	G 1/4	37.0	36.8	8.0	18.7	12	31.7
NSC08-G03(DC)	8	14.5	G 3/8	43.3	40.1	8.0	18.7	14	56.7
NSC08-G04(DC)	8	14.5	G 1/2	50.2	45.8	9.0	18.7	19	91.7
NSC10-G01(DC)	10	17.5	G 1/8	31.6	33.0	6.0	19.6	8	19.2
NSC10-G02(DC)	10	17.5	G 1/4	37.0	38.8	8.0	19.6	12	33.2
NSC10-G03(DC)	10	17.5	G 3/8	43.3	42.2	8.0	19.6	14	58.2
NSC10-G04(DC)	10	17.5	G 1/2	50.2	47.5	9.0	19.6	19	92.2
NSC12-G02(DC)	12	20.5	G 1/4	37.0	40.8	8.0	21.9	12	34.1
NSC12-G03(DC)	12	20.5	G 3/8	43.3	45.9	8.0	21.9	14	64.1
NSC12-G04(DC)	12	20.5	G 1/2	50.2	50.1	9.0	21.9	19	97.1

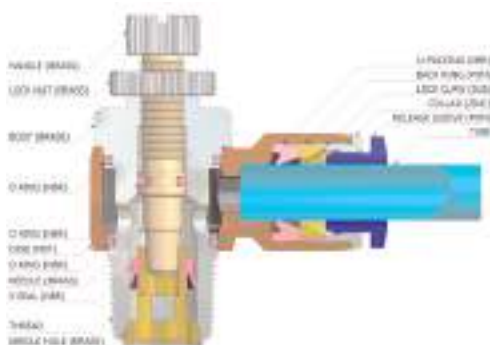

REGULADORES DE CAUDAL: Precisa regulación para un óptimo control del flujo de aire. Compactos y precisos, conforman un amplio ratio de regulación. Unidireccionales. Disponibles de regulación de rosca a tubo (pulsador azul) y de tubo a rosca (pulsador rojo) Aplicaciones de aire comprimido (No otras de gas o líquidos)

Presión de servicio Rango 0~150PSI 0~9.9Kgf/cm<sup>2</sup>(0~990KPa)  
 Vacío -29.5in Hg -750mmHg(-750Torr)  
 Temperatura de servicio: 32~140°F 0~60°C

**NSS : Regulador de Caudal Instantáneo Codo Orientable a 360°**



MODELO	D	P	T	L(Min)	L(Max)	A	A(-G)	B	C	E	G
NSS 04-M5	4	10.5	M5x0,8p	27.2	30.2	3.6	3.6	16.3	20.5	22.7	12.3
NSS 04-01	4	10.5	1/8	34.9	40.1	8.0	6.0	16.3	20.5	26.5	14.3
NSS 04-02	4	10.5	1/4	40.0	45.7	12.0	8.0	16.3	20.5	26.5	14.3
NSS 06-M5	6	12.5	M5x0,8p	27.3	30.2	3.6	3.6	17.6	22.5	24.7	13.3
NSS 06-01	6	12.5	1/8	34.9	40.1	8.0	6.0	17.6	24.1	28.5	15.0
NSS 06-02	6	12.5	1/4	40.0	45.7	12.0	8.0	17.6	26.0	36.0	20.3
NSS 06-03	6	12.5	3/8	46.7	55.0	14.0	8.0	17.6	26.0	41.3	23.3
NSS 08-01	8	14.5	1/8	34.9	40.1	8.0	6.0	18.7	25.4	30.6	16.2
NSS 08-02	8	14.5	1/4	40.0	45.7	12.0	8.0	18.7	28.8	36.0	19.3
NSS 08-03	8	14.5	3/8	46.7	55.0	14.0	8.0	18.7	29.8	43.6	24.6
NSS 08-04	8	14.5	1/2	53.0	60.2	17.0	9.0	18.7	29.8	48.4	26.6
NSS 10-02	10	17.5	1/4	40.0	45.7	12.0	8.0	19.6	30.7	38.2	20.3
NSS 10-03	10	17.5	3/8	46.7	55.0	14.0	8.0	19.6	31.7	44.9	24.6
NSS 10-04	10	17.5	1/2	53.0	60.2	17.0	9.0	19.6	33.2	49.8	26.7
NSS 12-02	12	20.5	1/4	40.0	45.7	12.0	8.0	21.9	33.4	41.2	21.8
NSS 12-03	12	20.5	3/8	46.7	55.0	14.0	8.0	21.9	34.4	46.4	24.6
NSS 12-04	12	20.5	1/2	53.0	60.2	17.0	9.0	21.9	35.9	51.3	26.7

**NSS(D): Regulador Caudal Instantáneo Tornillo Oculto Codo Orientable a 360°**

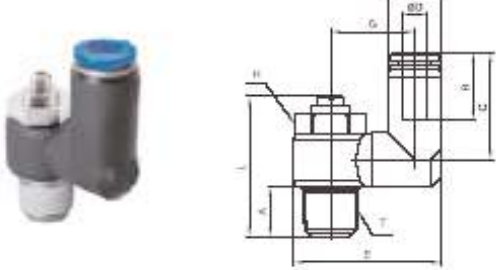

MODELO	D	P	T	L(Min)	L(Max)	A	A(-G)	B	C	E	G
NSS 04-M5(D)	4	10.5	M5x0,8p	27.2	30.2	3.6	3.6	16.3	20.5	22.7	12.3
NSS 04-01(D)	4	10.5	1/8	26.6	30.4	8.0	6.0	16.3	20.5	26.5	14.3
NSS 04-02(D)	4	10.5	1/4	31.3	36.3	12.0	8.0	16.3	20.5	26.5	14.3
NSS 06-M5(D)	6	12.5	M5x0,8p	27.3	30.2	3.6	3.6	17.6	22.5	24.7	13.3
NSS 06-01(D)	6	12.5	1/8	26.6	30.4	8.0	6.0	17.6	24.1	28.5	15.0
NSS 06-02(D)	6	12.5	1/4	31.3	36.3	12.0	8.0	17.6	26.0	36.0	20.3
NSS 06-03(D)	6	12.5	3/8	36.9	42.4	14.0	8.0	17.6	26.0	41.3	23.3
NSS 08-01(D)	8	14.5	1/8	26.6	30.4	8.0	6.0	18.7	25.4	30.6	16.2
NSS 08-02(D)	8	14.5	1/4	31.3	36.3	12.0	8.0	18.7	28.8	36.0	19.3
NSS 08-03(D)	8	14.5	3/8	36.9	42.4	14.0	8.0	18.7	29.8	43.6	24.6
NSS 08-04(D)	8	14.5	1/2	43.0	49.5	17.0	9.0	18.7	29.8	48.4	26.6
NSS 10-02(D)	10	17.5	1/4	31.3	36.3	12.0	8.0	19.6	30.7	38.2	20.3
NSS 10-03(D)	10	17.5	3/8	36.9	42.4	14.0	8.0	19.6	31.7	44.9	24.6
NSS 10-04(D)	10	17.5	1/2	43.0	49.5	17.0	9.0	19.6	33.2	49.8	26.7
NSS 12-02(D)	12	20.5	1/4	31.3	36.3	12.0	8.0	21.9	33.4	41.2	21.8
NSS 12-03(D)	12	20.5	3/8	36.9	42.4	14.0	8.0	21.9	34.4	46.4	24.6
NSS 12-04(D)	12	20.5	1/2	43.0	49.5	17.0	9.0	21.9	35.9	51.3	26.7

**NSS-DC : Regulador Caudal Inst. Tornillo Oculto Codo Orientable a 360°**

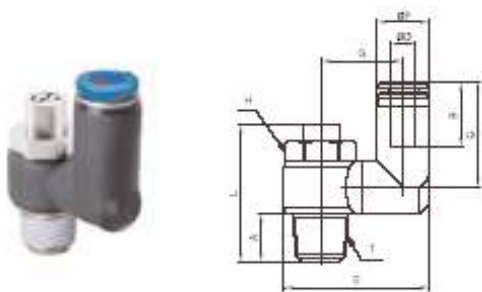

MODELO	D	P	T	L	A	A(-G)	B	C	E	G
NSS 04-M5(DC)	4	10.5	M5	27.2	3.6	3.6	16.3	20.5	22.7	12.3
NSS 04-01(DC)	4	10.5	G1/8	31.6	8.0	6.0	16.3	20.5	26.5	14.3
NSS 04-02(DC)	4	10.5	G1/4	37.0	12.0	8.0	16.3	20.5	26.5	14.3
NSS 06-M5(DC)	6	12.5	M5	27.3	30.2	3.6	17.6	22.5	24.7	13.3
NSS 06-01(DC)	6	12.5	G1/8	31.6	8.0	6.0	17.6	24.1	28.5	15.0
NSS 06-02(DC)	6	12.5	G1/4	37.0	12.0	8.0	17.6	26.0	36.0	20.3
NSS 06-03(DC)	6	12.5	G3/8	43.3	14.0	8.0	17.6	26.0	41.3	23.3
NSS 08-01(DC)	8	14.5	G1/8	31.6	8.0	6.0	18.7	25.4	30.6	16.2
NSS 08-02(DC)	8	14.5	G1/4	37.0	12.0	8.0	18.7	28.8	36.0	19.3
NSS 08-03(DC)	8	14.5	G3/8	43.3	14.0	8.0	18.7	29.8	43.6	24.6
NSS 08-04(DC)	8	14.5	G1/2	50.2	17.0	9.0	18.7	29.8	48.4	26.6
NSS 10-02(DC)	10	17.5	G1/4	37.0	12.0	8.0	19.6	30.7	38.2	20.3
NSS 10-03(DC)	10	17.5	G3/8	43.3	14.0	8.0	19.6	31.7	44.9	24.6
NSS 10-04(DC)	10	17.5	G1/2	50.2	17.0	9.0	19.6	33.2	49.8	26.7
NSS 12-02(DC)	12	20.5	G1/4	37.0	12.0	8.0	21.9	33.4	41.2	21.8
NSS 12-03(DC)	12	20.5	G3/8	43.3	14.0	8.0	21.9	34.4	46.4	24.6
NSS 12-04(DC)	12	20.5	G1/2	50.2	17.0	9.0	21.9	35.9	51.3	26.7

**NSF : Regulador de Caudal en línea**

**NSFB : Regulador Pasamuros**

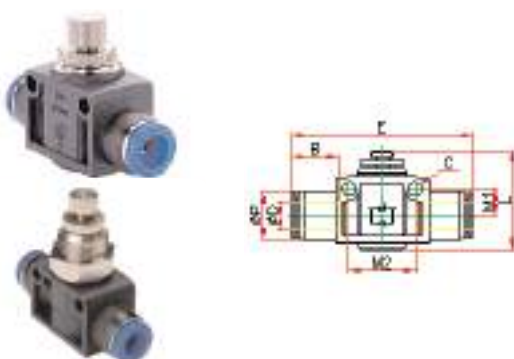

MODELO	D	P	L/min	L/max	E	C	B	M1	M2	PESO
NSF04	4	10.5	29.9	33.3	45.1	3.3	16.3	5.9	14.8	11.6
NSF06	6	12.5	35.0	39.5	50.3	4.3	17.6	8.3	20.5	26.4
NSF08	8	14.5	37.4	42.1	55.7	4.4	18.7	9.8	23.0	42.4
NSF10	10	17.5	43.8	49.0	61.2	4.4	19.6	10.7	28.0	75.4
NSF12	12	20.5	47.4	53.6	69.8	4.4	21.9	11.7	32.0	111.2
NSFB04	4	10.5	34.9	38.3	45.1	3.3	16.3	5.9	14.8	11.6
NSFB06	6	12.5	40.0	44.5	50.3	4.3	17.6	8.3	20.5	26.4
NSFB08	8	14.5	42.4	47.1	55.7	4.4	18.7	9.8	23.0	42.4
NSFB10	10	17.5	49.8	55.0	61.2	4.4	19.6	10.7	28.0	75.4
NSFB12	12	20.5	54.4	61.6	69.8	4.4	21.9	11.7	32.0	111.2



**NSFF : Regulador de caudal en línea rosca HxH  
(También referencia antigua VRE)**

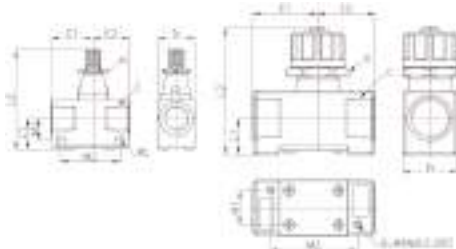

MODELO	T	P	H	C	N	E	B	A	K1	K2	L1	L2	M1	M2	PESO
NSFF 01	1/8	15.5	49.8	54.8	22.2	16.1	16.0	4.5	12	10.1	28.8				84.9
NSFF 02	1/4	17.1	52.5	57.7	22.3	19.2	19.9	4.5	12	11.4	31.4				116.9
NSFF 03	3/8	20.5	62.1	69.7	31.3	24.7	26.0	5.4	12	13.1	45.2				118.8
NSFF 04	1/2	19.1	67.4	77.0	34.2	30.2	29.0		29	18.0	46.0				176.9
VRE 01	1/8	15.5	49.8	54.8	22.2	16.1	16.0	4.5	12	10.1	28.8				84.9
VRE 02	1/4	17.1	52.5	57.7	22.3	19.2	19.9	4.5	12	11.4	31.4				116.9
VRE 03	3/8	20.5	62.1	69.7	31.3	24.7	26.0	5.4	12	13.1	45.2				118.8
VRE 04	1/2	19.1	67.4	77.0	34.2	30.2	29.0		29	18.0	46.0				176.9

**REGULADORES DE CAUDAL CON ESCAPE RAPIDO Y DESCARGA:**



Reguladores con Válvula de escape rápido automático y silenciador (ESC), o manual (NSFP, NSCP y NSSP). Presión de servicio 10 bar. Vacío 750 mmHg. Tubo de 4 a 12mm. Tubo PUR 98 shore y PA12. Sólo para aire comprimido.  
 Modelo ESC: Regulador con escape rápido automático y silenciador incorporado para operaciones en cilindros de alta velocidad.  
 Modelo NSFP: Regulador en línea roscado con válvula de descarga manual para la presión residual. Mantenimiento o reparaciones.  
 Resto de modelos NSCP y NSSP: Reguladores banjo Rosca a Tubo con Válvula de descarga manual para la presión residual.

**ESC: Regulador con Escape Rápido incorporado y Silenciador Instantáneo Reguación de Rosca > Tubo**



MODELO	D	P	T	L1	L2/min	L2/max	E1	E2	A	B	H	PESO
ESC 04-M3	4	10.3	M3*0.5p	11.9	32.2	34.7	25.8	4.9	3.0	14.8	8	11.4
ESC 04-M5	4	10.3	M5*0.8p	11.9	32.2	34.7	25.8	4.9	3.6	14.8	8	11.3
ESC 06-M5	6	12.5	M5*0.8p	11.9	32.2	34.7	26.4	4.9	3.6	16.5	8	12.3
ESC 06-S-01	6	12.5	R 1/8	24.5	63.3	72.0	29.3	8.8	8.0	16.5	10	21.5
ESC 06-S-02	6	12.5	R 1/4	24.5	63.3	72.0	31.3	8.8	10.0	16.5	14	26.3
ESC 08-S-01	8	14.8	R 1/8	26.5	65.1	71.7	29.3	8.8	8.0	18.3	10	22.5
ESC 08-S-02	8	14.8	R 1/4	26.5	65.1	71.7	31.3	8.8	10.0	18.3	14	27.4
ESC 08-M-01	8	14.8	R 1/8	29.8	73.2	82.3	34.5	12.0	8.0	18.3	14	40.0
ESC 08-M-02	8	14.8	R 1/4	29.8	73.2	82.3	37.5	12.0	10.0	18.3	14	42.9
ESC 08-M-03	8	14.8	R 3/8	29.8	73.2	82.3	38.5	12.0	11.0	18.3	17	48.5
ESC 10-M-01	10	17.5	R 1/8	31.7	75.0	84.1	34.5	12.0	8.0	20.1	14	41.7
ESC 10-M-02	10	17.5	R 1/4	31.7	75.0	84.1	37.5	12.0	10.0	20.1	14	44.7
ESC 10-M-03	10	17.5	R 3/8	31.7	75.0	84.1	38.5	12.0	11.0	20.1	17	50.2
ESC 10-L-02	10	17.5	R 1/4	34.4	80.1	88.6	42.4	15.0	10.0	20.1	19	72.5
ESC 10-L-03	10	17.5	R 3/8	34.4	80.1	88.6	43.4	15.0	11.0	20.1	19	76.5
ESC 10-L-04	10	17.5	R 1/2	34.4	80.1	88.6	46.4	15.0	14.0	20.1	21	85.2
ESC 12-L-02	12	20.5	R 1/4	37.1	83.1	91.6	42.4	15.0	10.0	23.1	19	75.2
ESC 12-L-03	12	20.5	R 3/8	37.1	83.1	91.6	43.4	15.0	11.0	23.1	19	79.2
ESC 12-L-04	12	20.5	R 1/2	37.1	83.1	91.6	46.4	15.0	14.0	23.1	21	88.1

**NSFP : Regulador caudal en línea rosca HxH con descarga manual**



MODELO	T	L	L1/min	L2/max	E1	E2	N	C	H	M1	M2	PESO
NSFP 01	1/8	15.5	57.2	62.2	22.2	16.1	16.0	4.5	12	10.1	28.8	86.8
NSFP 02	1/4	17.1	60.3	65.5	22.3	19.2	19.9	4.5	14	11.4	31.4	118.8
NSFP 03	3/8	20.5	70.3	77.9	31.3	24.7	26.0	5.4	14	13.1	45.2	120.6
NSFP 04	1/2	19.1	71.0	80.6	34.2	30.2	29.0		29	18.0	46.0	183.3

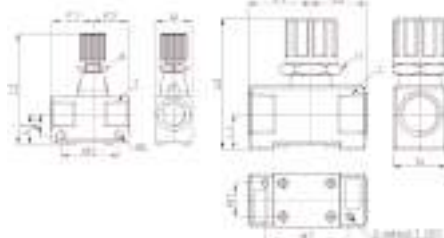

**NSCP : Regulador de caudal con válvula manual descarga. Rosca con> Tubo**

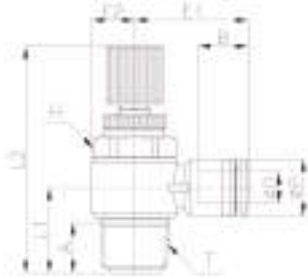

MODELO	T	P	H	C	N	E	B	A	K1	K2	L1	L2	M
NSCP 04-01	4	10.5	R 1/8	15.1	52.4	57.6	23.3	7.0	8.2	15.3	11	29.1	25
NSCP 04-02	4	10.5	R 1/4	18.4	51.3	57.1	25.3	9.0	11.0	15.3	15	40.2	25
NSCP 06-01	6	12.5	R 1/8	15.1	52.4	57.6	24.2	7.0	8.2	16.4	11	29.8	25
NSCP 06-02	6	12.5	R 1/4	18.4	51.3	57.1	26.2	9.0	11.0	16.4	15	41.1	25
NSCP 06-03	6	12.5	R 3/8	21.9	57.0	64.4	27.7	11.0	12.2	16.4	19	65.7	25
NSCP 06-04	6	12.5	R 1/2	26.5	63.4	70.6	30.8	14.0	16.5	16.4	24	103.0	15
NSCP 08-01	8	14.5	R 1/8	16.2	52.4	57.6	25.9	7.0	8.2	18.3	11	30.8	25
NSCP 08-02	8	14.5	R 1/4	19.2	51.3	57.1	27.9	9.0	11.0	18.3	15	42.1	25
NSCP 08-03	8	14.5	R 3/8	21.9	57.0	64.4	28.9	11.0	12.2	18.3	19	66.6	25
NSCP 08-04	8	14.5	R 1/2	26.5	63.4	70.6	31.8	14.0	16.5	18.3	24	103.8	15
NSCP 10-01	10	17.5	R 1/8	17.7	52.4	57.6	27.9	7.0	8.2	19.7	11	32.6	25
NSCP 10-02	10	17.5	R 1/4	20.7	51.3	57.1	29.9	9.0	11.0	19.7	15	43.9	25
NSCP 10-03	10	17.5	R 3/8	23.2	57.0	64.4	31.0	11.2	12.2	19.7	19	68.3	25
NSCP 10-04	10	17.5	R 1/2	26.5	63.4	70.6	33.4	14.0	16.5	19.7	24	105.5	15
NSCP 12-02	12	20.5	R 1/4	22.2	51.3	57.1	33.3	9.0	11.0	22.4	15	46.9	25
NSCP 12-03	12	20.5	R 3/8	24.0	57.0	64.4	33.7	11.5	12.2	21.9	19	71.1	25
NSCP 12-04	12	20.5	R 1/2	28.0	63.4	70.6	36.1	14.0	16.5	21.9	24	107.9	15

**NSCP : Regulador de caudal con válvula manual descarga. Rosca con> Tubo**



MODELO	T	P	H	C	N	E	B	A	K1	K2	L1	L2	M
NSCP 04-01	4	10.5	R 1/8	15.1	52.4	57.6	23.3	7.0	8.2	15.3	11	29.1	25
NSCP 04-02	4	10.5	R 1/4	18.4	51.3	57.1	25.3	9.0	11.0	15.3	15	40.2	25
NSCP 06-01	6	12.5	R 1/8	15.1	52.4	57.6	24.2	7.0	8.2	16.4	11	29.8	25
NSCP 06-02	6	12.5	R 1/4	18.4	51.3	57.1	26.2	9.0	11.0	16.4	15	41.1	25
NSCP 06-03	6	12.5	R 3/8	21.9	57.0	64.4	27.7	11.0	12.2	16.4	19	65.7	25
NSCP 06-04	6	12.5	R 1/2	26.5	63.4	70.6	30.8	14.0	16.5	16.4	24	103.0	15
NSCP 08-01	8	14.5	R 1/8	16.2	52.4	57.6	25.9	7.0	8.2	18.3	11	30.8	25
NSCP 08-02	8	14.5	R 1/4	19.2	51.3	57.1	27.9	9.0	11.0	18.3	15	42.1	25
NSCP 08-03	8	14.5	R 3/8	21.9	57.0	64.4	28.9	11.0	12.2	18.3	19	66.6	25
NSCP 08-04	8	14.5	R 1/2	26.5	63.4	70.6	31.8	14.0	16.5	18.3	24	103.8	15
NSCP 10-01	10	17.5	R 1/8	17.7	52.4	57.6	27.9	7.0	8.2	19.7	11	32.6	25
NSCP 10-02	10	17.5	R 1/4	20.7	51.3	57.1	29.9	9.0	11.0	19.7	15	43.9	25
NSCP 10-03	10	17.5	R 3/8	23.2	57.0	64.4	31.0	11.2	12.2	19.7	19	68.3	25
NSCP 10-04	10	17.5	R 1/2	26.5	63.4	70.6	33.4	14.0	16.5	19.7	24	105.5	15
NSCP 12-02	12	20.5	R 1/4	22.2	51.3	57.1	33.3	9.0	11.0	22.4	15	46.9	25
NSCP 12-03	12	20.5	R 3/8	24.0	57.0	64.4	33.7	11.5	12.2	21.9	19	71.1	25
NSCP 12-04	12	20.5	R 1/2	28.0	63.4	70.6	36.1	14.0	16.5	21.9	24	107.9	15

**ESC: Regulador con Escape Rápido incorporado y Silenciador Instantáneo Regulación de Rosca > Tubo**

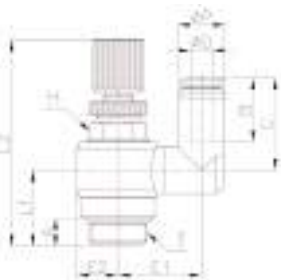

MODELO	T	P	H	C	N	E	B	A	K1	K2	L1	L2
NSSP 04-G01	4	10.5	G 1/8	15.1	52.4	57.6	14.3	7.0	6.0	14.8	11	20.3
NSSP 04-G02	4	10.5	G 1/4	17.6	51.3	57.1	17.8	9.2	8.0	14.8	12	20.2
NSSP 06-G01	6	12.5	G 1/8	15.6	52.4	57.6	15.0	7.0	6.0	16.4	11	24.0
NSSP 06-G02	6	12.5	G 1/4	18.4	51.3	57.1	20.3	9.2	8.0	16.4	12	25.9
NSSP 06-G03	6	12.5	G 3/8	21.9	57.0	64.4	23.3	11.5	8.0	16.4	14	25.9
NSSP 08-G01	8	14.8	G 1/8	15.6	52.4	57.6	16.2	7.0	6.0	18.3	11	24.9
NSSP 08-G02	8	14.8	G 1/4	17.6	51.3	57.1	19.3	9.2	8.0	18.3	12	28.3
NSSP 08-G03	8	14.8	G 3/8	21.9	57.0	64.4	24.6	11.5	8.0	18.3	14	29.3
NSSP 08-G04	8	14.8	G 1/2	23.0	63.4	70.6	26.6	14.3	9.0	18.3	17	29.3
NSSP 10-G02	10	17.5	G 1/4	17.6	51.3	57.1	20.3	9.2	8.0	20.2	12	30.7
NSSP 10-G03	10	17.5	G 3/8	21.9	57.0	64.4	24.6	11.5	8.0	20.2	14	31.7
NSSP 10-G04	10	17.5	G 1/2	23.2	63.4	70.6	26.7	14.3	9.0	20.2	17	33.1
NSSP 12-G02	12	20.5	G 1/4	17.6	51.3	57.1	21.8	9.2	8.0	22.9	12	33.4
NSSP 12-G03	12	20.5	G 3/8	21.9	57.0	64.4	24.6	11.5	8.0	22.9	14	34.4
NSSP 12-G04	12	20.5	G 1/2	23.2	63.4	70.6	26.7	14.3	9.0	22.9	17	35.8

**VÁLVULAS 3 VIAS CON DESCARGA CDC:**

Válvulas de cierre. Al posicionar la válvula en "Off" el resto de línea queda descargada de presión. También es válvula unidireccional puesto que el aire circula en un sólo sentido (dibujado en la válvula). Presión de servicio 10 bar. Vacío 750 mmHg. Tubo de 6 a 12mm. Tubo de poliuretano 98 shore y PA12. Sólo para aire comprimido.



**HVC : Válvula 3 Vías Cónica Tubo > Rosca**

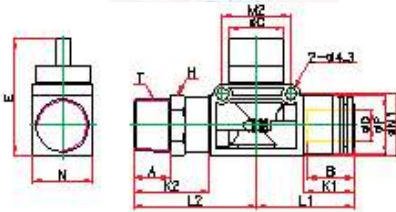

MODELO	D	T	P	H	C	N	E	B	A	K1	K2	L1	L2	M1	M2	PESO
HVC06-01	6	R 1/8	12.5	14	16.5	18.0	40.5	17.6	8.0	12.2	21.6	26.2	35.6	18.3	19.0	34.7
HVC06-02	6	R 1/4	12.5	14	16.5	18.0	40.5	17.6	10.0	12.2	24.6	26.2	38.6	18.3	19.0	38.7
HVC06-03	6	R 3/8	12.5	17	16.5	18.0	40.5	17.6	11.0	12.2	25.6	26.2	39.6	18.3	19.0	46.7
HVC08-01	8	R 1/8	14.8	14	16.5	18.0	40.5	18.7	8.0	13.0	21.6	27.5	35.6	18.3	19.0	34.7
HVC08-02	8	R 1/4	14.8	14	16.5	18.0	40.5	18.7	10.0	13.0	24.6	27.5	38.6	18.3	19.0	38.7
HVC08-03	8	R 3/8	14.8	17	16.5	18.0	40.5	18.7	11.0	13.0	25.6	27.5	39.6	18.3	19.0	46.7
HVC10-02	10	R 1/4	17.5	17	19.3	21.2	41.0	19.6	10.0	14.5	23.0	31.0	39.5	21.5	24.0	57.2
HVC10-03	10	R 3/8	17.5	17	19.3	21.2	41.0	19.6	11.0	14.5	24.0	31.0	40.5	21.5	24.0	61.2
HVC10-04	10	R 1/2	17.5	21	19.3	21.2	41.0	19.6	14.0	14.5	27.0	31.0	43.5	21.5	24.0	80.2
HVC12-02	12	R 1/4	20.5	19	19.3	21.2	41.0	21.9	10.0	17.7	24.6	34.2	41.1	21.5	24.0	69.1
HVC12-03	12	R 3/8	20.5	19	19.3	21.2	41.0	21.9	11.0	17.7	25.6	34.2	42.1	21.5	24.0	67.1
HVC12-04	12	R 1/2	20.5	21	19.3	21.2	41.0	21.9	14.0	17.7	28.6	34.2	45.1	21.5	24.0	79.1



**HVC-G : Válvula 3 Vías Cilíndrica Tubo > Rosca**

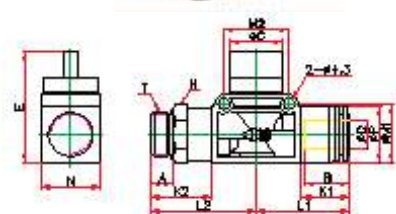

MODELO	D	T	P	H	C	N	E	B	A	K1	K2	L1	L2	M1	M2	PESO
HVC06G01	6	R 1/8	12.5	14	16.5	18.0	40.5	17.6	5.0	12.2	21.6	26.2	35.6	18.3	19.0	34.7
HVC06G02	6	R 1/4	12.5	14	16.5	18.0	40.5	17.6	6.5	12.2	24.6	26.2	38.6	18.3	19.0	38.7
HVC06G03	6	R 3/8	12.5	17	16.5	18.0	40.5	17.6	6.5	12.2	25.6	26.2	39.6	18.3	19.0	46.7
HVC08G01	8	R 1/8	14.8	14	16.5	18.0	40.5	18.7	5.0	13.0	21.6	27.5	35.6	18.3	19.0	34.7
HVC08G02	8	R 1/4	14.8	14	16.5	18.0	40.5	18.7	6.5	13.0	24.6	27.5	38.6	18.3	19.0	38.7
HVC08G03	8	R 3/8	14.8	17	16.5	18.0	40.5	18.7	6.5	13.0	25.6	27.5	39.6	18.3	19.0	46.7
HVC10G02	10	R 1/4	17.5	17	19.3	21.2	41.0	19.6	6.5	14.5	23.0	31.0	39.5	21.5	24.0	57.2
HVC10G03	10	R 3/8	17.5	17	19.3	21.2	41.0	19.6	6.5	14.5	24.0	31.0	40.5	21.5	24.0	61.2
HVC10G04	10	R 1/2	17.5	21	19.3	21.2	41.0	19.6	8.0	14.5	27.0	31.0	43.5	21.5	24.0	80.2
HVC12G02	12	R 1/4	20.5	19	19.3	21.2	41.0	21.9	6.5	17.7	24.6	34.2	41.1	21.5	24.0	69.1
HVC12G03	12	R 3/8	20.5	19	19.3	21.2	41.0	21.9	6.5	17.7	25.6	34.2	42.1	21.5	24.0	67.1
HVC12G04	12	R 1/2	20.5	21	19.3	21.2	41.0	21.9	8.0	17.7	28.6	34.2	45.1	21.5	24.0	79.1



**HVF : Válvula 3 Vías Cónica Rosca > Tubo**

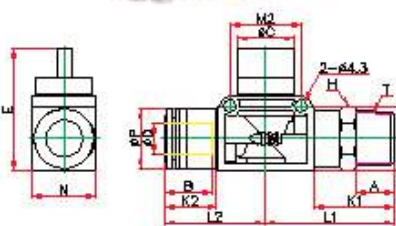

MODELO	T	D	H	P	C	N	E	A	B	K1	K2	L1	L2	M1	M2	PESO
HVF01-06	R 1/8	6	14	12.5	16.5	18.0	40.5	8.0	17.6	21.6	12.2	35.6	26.2	18.3	19.0	34.7
HVF02-06	R 1/4	6	14	12.5	16.5	18.0	40.5	10.0	17.6	24.6	12.2	38.6	26.2	18.3	19.0	38.7
HVF03-06	R 3/8	6	17	12.5	16.5	18.0	40.5	11.0	17.6	25.6	12.2	39.6	26.2	18.3	19.0	46.7
HVF01-08	R 1/8	8	14	14.8	16.5	18.0	40.5	8.0	18.7	21.6	13.0	35.6	27.5	18.3	19.0	34.7
HVF02-08	R 1/4	8	14	14.8	16.5	18.0	40.5	10.0	18.7	24.6	13.0	38.6	27.5	18.3	19.0	38.7
HVF03-08	R 3/8	8	17	14.8	16.5	18.0	40.5	11.0	18.7	25.6	13.0	39.6	27.5	18.3	19.0	46.7
HVF02-10	R 1/4	10	17	17.5	19.3	21.2	41.0	10.0	19.6	23.0	14.5	39.5	31.0	21.5	24.0	57.2
HVF03-10	R 3/8	10	17	17.5	19.3	21.2	41.0	11.0	19.6	24.0	14.5	40.5	31.0	21.5	24.0	61.2
HVF04-10	R 1/2	10	21	17.5	19.3	21.2	41.0	14.0	19.6	27.0	14.5	43.5	31.0	21.5	24.0	80.2
HVF02-12	R 1/4	12	19	20.5	19.3	21.2	41.0	10.0	21.9	24.6	17.7	41.1	34.2	21.5	24.0	69.1
HVF03-12	R 3/8	12	19	20.5	19.3	21.2	41.0	11.0	21.9	25.6	17.7	42.1	34.2	21.5	24.0	67.1
HVF04-12	R 1/2	12	21	20.5	19.3	21.2	41.0	14.0	21.9	28.6	17.7	45.1	34.2	21.5	24.0	79.1



**HVF-G : Válvula 3 Vías Cilíndrica Rosca > Tubo**

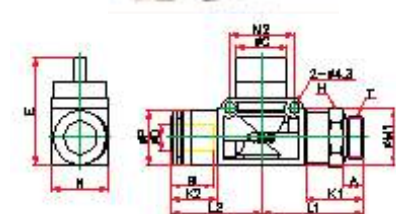

MODELO	T	D	H	P	C	N	E	A	B	K1	K2	L1	L2	M1	M2	PESO
HVF01-G06	1/8	6	14	12.5	16.5	18.0	40.5	5.0	17.6	21.6	12.2	35.6	26.2	18.3	19.0	34.7
HVF02-G06	1/4	6	14	12.5	16.5	18.0	40.5	6.5	17.6	24.6	12.2	38.6	26.2	18.3	19.0	38.7
HVF03-G06	3/8	6	17	12.5	16.5	18.0	40.5	6.5	17.6	25.6	12.2	39.6	26.2	18.3	19.0	46.7
HVF01-G08	1/8	8	14	14.8	16.5	18.0	40.5	5.0	18.7	21.6	13.0	35.6	27.5	18.3	19.0	34.7
HVF02-G08	1/4	8	14	14.8	16.5	18.0	40.5	6.5	18.7	24.6	13.0	38.6	27.5	18.3	19.0	38.7
HVF03-G08	3/8	8	17	14.8	16.5	18.0	40.5	6.5	18.7	25.6	13.0	39.6	27.5	18.3	19.0	46.7
HVF02-G10	1/4	10	17	17.5	19.3	21.2	41.0	6.5	19.6	23.0	14.5	39.5	31.0	21.5	24.0	57.2
HVF03-G10	3/8	10	17	17.5	19.3	21.2	41.0	6.5	19.6	24.0	14.5	40.5	31.0	21.5	24.0	61.2
HVF04-G10	1/2	10	21	17.5	19.3	21.2	41.0	8.0	19.6	27.0	14.5	43.5	31.0	21.5	24.0	80.2
HVF02-G12	1/4	12	19	20.5	19.3	21.2	41.0	6.5	21.9	24.6	17.7	41.1	34.2	21.5	24.0	69.1
HVF03-G12	3/8	12	19	20.5	19.3	21.2	41.0	6.5	21.9	25.6	17.7	42.1	34.2	21.5	24.0	67.1
HVF04-G12	1/2	12	21	20.5	19.3	21.2	41.0	8.0	21.9	28.6	17.7	45.1	34.2	21.5	24.0	79.1

**HVU : Válvula 3 Vías Tubo > Tubo**

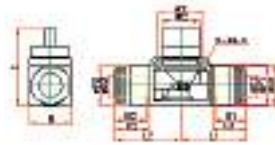

MODELO	D1	D2	P1	P2	C	N	E	B1	B2	K1	K2	L1	L2	M1	M2	PESO
HVU06-06	6	6	12.5	12.5	16.5	18.0	40.5	17.6	17.6	12.2	12.2	26.2	26.2	18.3	19.0	23.4
HVU08-06	8	6	14.8	12.5	16.5	18.0	40.5	18.7	17.6	13.0	12.2	27.5	26.2	18.3	19.0	23.4
HVU08-08	8	8	14.8	14.8	16.5	18.0	40.5	18.7	18.7	13.0	13.0	27.5	27.5	18.3	19.0	24.4
HVU10-08	10	8	17.5	14.8	19.3	21.2	41.0	19.6	18.7	14.5	13.0	31.0	27.5	21.5	24.0	37.9
HVU10-10	10	10	17.5	17.5	19.3	21.2	41.0	19.6	19.6	14.5	14.5	31.0	31.0	21.5	24.0	38.4
HVU12-10	12	10	20.5	17.5	19.3	21.2	41.0	21.9	19.6	17.7	14.5	34.2	31.0	21.5	24.0	41.3
HVU12-12	12	12	20.5	20.5	19.3	21.2	41.0	21.9	21.9	17.7	17.7	34.2	34.2	21.5	24.0	46.2

**HVM : Válvula 3 Vías Cónica Rosca > Rosca**

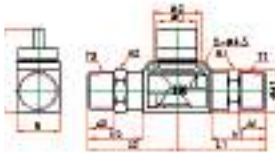

MODELO	T1	T2	H1	H2	C	N	E	A1	A2	K1	K2	L1	L2	M1	M2	PESO
HVM01-01	R1/8	R1/8	14	14	16.5	18.0	40.5	8.0	8.0	21.6	21.6	35.6	35.6	18.3	19.0	45.0
HVM02-01	R1/4	R1/8	14	14	16.5	18.0	40.5	10.0	8.0	24.6	21.6	38.6	35.6	18.3	19.0	48.0
HVM02-02	R1/4	R1/4	14	14	16.5	18.0	40.5	10.0	10.0	24.6	24.6	38.6	38.6	18.3	19.0	52.0
HVM03-02	R3/8	R1/4	17	17	19.3	21.2	41.0	11.0	10.0	24.0	24.6	40.5	38.6	21.5	24.0	80.0
HVM03-03	R3/8	R3/8	17	17	19.3	21.2	41.0	11.0	11.0	24.0	24.0	40.5	40.5	21.5	24.0	83.0
HVM04-03	R1/2	R3/8	21	19	19.3	21.2	41.0	14.0	11.0	28.6	24.0	45.1	40.5	21.5	24.0	102.0
HVM04-04	R1/2	R1/2	21	21	19.3	21.2	41.0	14.0	14.0	28.6	28.6	45.1	45.1	21.5	24.0	116.0

**HVM-G : Válvula 3 Vías Cilíndrica Rosca > Rosca**



MODELO	H1	H2	C	N	E	A1	A2	K1	K2	L1	L2	M1	M2	PESO
HVM G01-G01	14	14	16.5	18.0	40.5	5.0	5.0	18.6	18.6	32.6	32.6	18.3	19.0	42.0
HVM G02-G01	17	14	16.5	18.0	40.5	6.5	5.0	20.1	18.6	34.1	32.6	18.3	19.0	49.0
HVM G02-G02	17	17	16.5	18.0	40.5	6.5	6.5	20.1	20.1	34.1	34.1	18.3	19.0	57.0
HVM G03-G02	20	17	19.3	21.2	41.0	6.5	6.5	18.5	18.5	35.0	35.0	21.5	24.0	69.0
HVM G03-G03	20	20	19.3	21.2	41.0	6.5	6.5	18.5	18.5	35.0	35.0	21.5	24.0	75.0
HVM G04-G03	24	20	19.3	21.2	41.0	8.0	6.5	21.6	20.1	38.1	36.6	21.5	24.0	90.0
HVM G04-G04	24	24	19.3	21.2	41.0	8.0	8.0	21.6	21.6	38.1	38.1	21.5	24.0	100.0

**HSV : Válvula Corredera Macho-Macho**

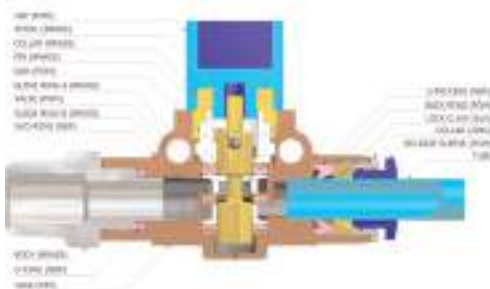

MODELO	Ancho	T	Largo	Orificio	PESO
HSV M5	19.0	M5*0.8p	45.0	2.6	24.0
HSV 01	24.0	R 1/8	54.0	5.0	45.0
HSV 02	30.0	R 1/4	73.5	8.0	112.0
HSV 03	41.0	R 3/8	83.0	10.0	276.0
HSV 04	41.0	R 1/2	89.0	13.0	270.0
HSV 05	49.0	R 3/4	104.5	18.8	407.0

**VÁLVULAS DE BLOQUEO CDC:**

Válvulas de Bloqueo. Actúan como un enchufe rápido siendo el tubo el propio conector macho. Monta un resorte interior que, al insertar el tubo en el racor abre el paso del aire. Asimismo, al desconectar el tubo, la válvula vuelve a cerrar el paso. No hay dirección de paso, puede ser en un sentido o en otro. Ideal para aplicaciones test o demostraciones de neumática.

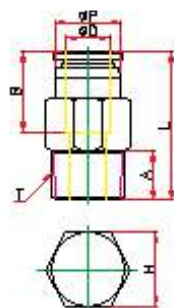

**SPC : Válvula Bloqueo Recto Cónica Rosca- Tubo**

MODELO	D	P	T	L	A	B	H	PESO
SPC04-01	4	10.0	R 1/8	26.1	8.0	15.3	10	10.8
SPC06-01	6	12.0	R 1/8	28.8	8.0	17.0	12	12.8
SPC06-02	6	12.0	R 1/4	28.8	10.0	17.0	14	20.8
SPC08-02	8	14.0	R 1/4	33.3	10.0	18.6	14	19.7
SPC08-03	8	14.0	R 3/8	33.3	11.0	18.6	17	38.7
SPC10-02	10	17.0	R 1/4	35.6	10.0	20.3	17	28.5
SPC10-03	10	17.0	R 3/8	35.6	11.0	20.3	17	33.5
SPC10-04	10	17.0	R 1/2	35.6	14.0	20.3	21	60.5
SPC12-02	12	18.8	R 1/4	41.9	10.0	22.7	19	44.3
SPC12-03	12	18.8	R 3/8	41.9	11.0	22.7	19	58.3
SPC12-04	12	18.8	R 1/2	41.9	14.0	22.7	21	66.3

**SPC-G : Válvula Bloqueo Recto Cilíndrica Rosca- Tubo**

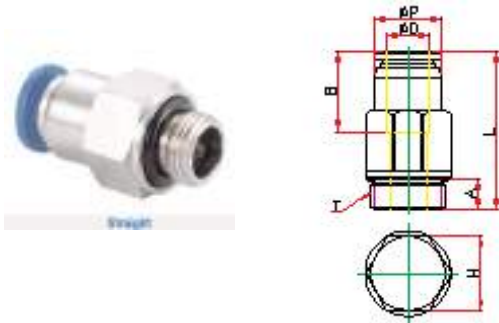

MODELO	D	P	T	L	A	B	H	PESO
SPC04-G01	4	10.3	G 1/8	25.5	5.0	15.5	12	14.8
SPC06-G01	6	12.0	G 1/8	27.7	5.0	17.0	12	13.8
SPC06-G02	6	12.0	G 1/4	27.2	6.5	17.0	15	23.8
SPC08-G02	8	14.0	G 1/4	31.9	6.5	18.6	15	22.7
SPC08-G03	8	14.0	G 3/8	31.9	6.5	18.6	17	34.7
SPC10-G02	10	17.0	G 1/4	34.9	6.5	20.3	17	30.5
SPC10-G03	10	17.0	G 3/8	36.4	6.5	20.3	17	35.5
SPC10-G04	10	17.0	G 1/2	37.4	8.0	20.3	21	57.5
SPC12-G02	12	18.8	G 1/4	43.3	6.5	22.7	19	49.3
SPC12-G03	12	18.8	G 3/8	43.3	6.5	22.7	21	62.3
SPC12-G04	12	18.8	G 1/2	43.8	8.0	22.7	21	64.3

**SPL : Válvula Bloqueo Codo Cónica Rosca- Tubo**



MODELO	D	P	T	L	A	B	H	PESO	
SPL04-M5	4	10.0	M5*0.8p	27.3	34.5	4.6	15.3	10	15.8
SPL04-M6	4	10.0	M6*1.0p	26.9	34.5	4.1	15.3	10	15.8
SPL04-01	4	10.0	R 1/8	29.8	34.5	8.0	15.3	10	19.8
SPL06-M5	6	12.0	M5*0.8p	30.3	38.9	4.6	17.0	12	19.8
SPL06-01	6	12.0	R 1/8	32.8	38.9	8.0	17.0	12	20.8
SPL06-02	6	12.0	R 1/4	35.8	38.9	10.0	17.0	14	30.8
SPL08-01	8	14.0	R 1/8	38.2	48.6	8.0	18.6	14	31.7
SPL08-02	8	14.0	R 1/4	41.2	48.6	10.0	18.6	14	38.7
SPL10-02	10	17.0	R 1/4	40.3	55.0	10.0	20.3	17	55.5
SPL10-03	10	17.0	R 3/8	41.3	55.0	11.0	20.3	17	65.5
SPL10-04	10	17.0	R 1/2	44.3	55.0	14.0	20.3	21	89.5
SPL12-03	12	18.8	R 3/8	45.7	63.7	11.0	22.7	19	83.3
SPL12-04	12	18.8	R 1/2	48.7	63.7	14.0	22.7	21	106.3

**SPL-G : Válvula Bloqueo Codo Cilíndrica Rosca- Tubo**

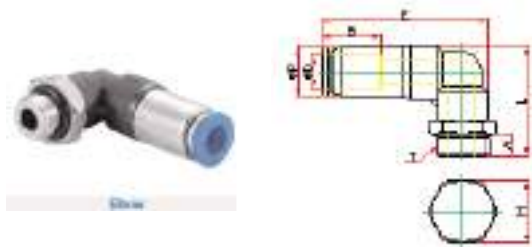

MODELO	D	P	T	L	E	A	B	H	PESO
SPL04-G01	4	10.0	G 1/8	26.8	34.5	5.0	15.3	14	18.8
SPL06-G01	6	12.0	G 1/8	29.8	38.9	5.0	17.0	14	22.8
SPL06-G02	6	12.0	G 1/4	31.8	38.9	6.5	17.0	17	29.8
SPL08-G02	8	14.0	G 1/4	37.2	48.6	6.5	18.6	17	37.7
SPL08-G03	8	14.0	G 3/8	36.7	48.6	6.5	18.6	20	41.7
SPL10-G02	10	17.0	G 1/4	31.8	55.0	6.5	20.3	17	49.5
SPL10-G03	10	17.0	G 3/8	35.8	55.0	6.5	20.3	20	56.5
SPL10-G04	10	17.0	G 1/2	37.3	55.0	8.0	20.3	24	68.5
SPL12-G03	12	18.8	G 3/8	40.2	63.7	6.5	22.7	20	71.3
SPL12-G04	12	18.8	G 1/2	41.7	63.7	8.0	22.7	24	84.3

**SPU : Válvula Bloqueo Tubo- Tubo**

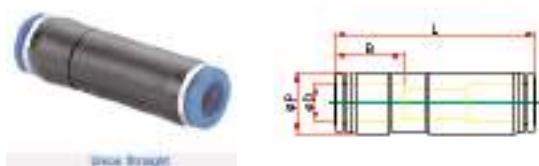

MODELO	D	P	L	B	PESO
SPU04	4	10.5	42.1	15.7	6.6
SPU06	6	12.5	46.0	17.0	7.4
SPU08	8	14.8	53.7	19.1	12.4
SPU10	10	17.5	58.2	20.2	21.4
SPU12	12	20.5	67.1	22.7	35.2

## VÁLVULAS ANTIRRETORNO CDC:

Válvulas Antirretorno Unidireccionales. Mientras el aire fluya o no desde un lado de la válvula, al otro lado nunca habrá retorno de aire en sentido contrario aunque haya diferente presión. Posición "IN" Antirretornos con flujo de rosca macho hacia rosca hembra o a tubo. Posición "OUT" gama en stock, flujo de rosca hembra o tubo hacia la rosca macho.

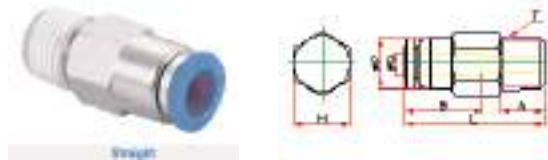

### CVPC (out) : Válvula Antirretorno Cónica Rosca - Tubo

MODELO	D	P	T	L	A	B	H	PESO
CVPC04-M5	4	10.0	M5*0.8p	31.4	3.6	15.3	10	11.8
CVPC04-M6	4	10.0	M6*1.0p	30.4	4.6	15.3	10	11.8
CVPC04-01	4	10.0	R 1/8	27.3	8.0	15.3	10	9.8
CVPC06-01	6	11.9	R 1/8	32.6	8.0	16.3	12	12.8
CVPC06-02	6	11.9	R 1/8	32.6	8.0	16.3	14	19.8
CVPC08-01	8	11.9	R 1/4	32.6	10.0	16.3	14	19.8
CVPC08-02	8	14.0	R 1/4	37.2	10.0	18.3	14	20.7
CVPC10-03	10	23.0	R 3/8	56.3	11.0	20.3	22	45.5
CVPC10-04	10	23.0	R 1/2	58.3	14.0	20.3	22	63.5
CVPC12-03	12	25.0	R 3/8	62.3	12.0	23.3	24	48.3
CVPC12-04	12	25.0	R 1/2	65.3	14.0	23.3	24	68.3



### CVPC -G (out) : Válvula Antirretorno Cilíndrica Rosca - Tubo

MODELO	D	P	T	L	A	B	H	PESO
CVPC04-G01	4	10.0	G 1/8	26.3	5.0	15.3	10	11.8
CVPC06-G01	6	11.9	G 1/8	31.6	5.0	17.0	12	15.8
CVPC06-G02	6	11.9	G 1/4	32.1	6.5	17.0	15	25.8
CVPC08-G01	8	14.0	G 1/8	33.8	5.0	18.6	14	16.7
CVPC08-G02	8	14.0	G 1/4	36.7	6.5	18.6	15	25.7
CVPC10-G03	10	23.0	G 3/8	52.5	6.5	20.3	22	33.5
CVPC10-G04	10	23.0	G 1/2	54.3	6.5	20.3	22	39.5
CVPC12-G03	12	25.0	G 3/8	57.5	6.5	23.3	24	41.3
CVPC12-G04	12	25.0	G 1/2	59.3	8.0	23.3	24	44.3

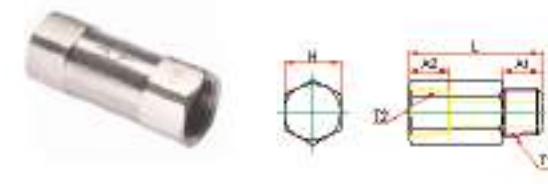

### CVFF : Válvula Antirretorno Cónica Rosca H - Rosca H

MODELO	T1	T2	L	A1	A2	H	PESO
CVPF01-01	R /18	R 1/8	28.1	8.0	8.0	12	16.0
CVPF04-04	R 1/4	R 1/4	34.1	11.0	10.0	17	39.0
CVPF03-03	R 3/8	R 3/8	53.8	12.0	11.0	22	107.0
CVPF04-04	R 1/2	R 1/2	61.0	14.0	14.0	24	130.0

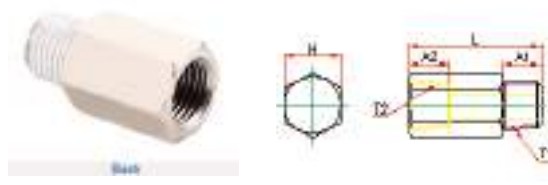

### CVPF(out) : Válvula Antirretorno Cónica Rosca - Rosca

MODELO	T1	T2	L	A1	A2	H	PESO
CVPF01-01	R /18	R 1/8	28.1	8.0	8.0	12	16.0
CVPF04-04	R 1/4	R 1/4	34.1	11.0	10.0	17	39.0
CVPF03-03	R 3/8	R 3/8	53.8	12.0	11.0	22	107.0
CVPF04-04	R 1/2	R 1/2	61.0	14.0	14.0	24	130.0



### CVPF-G (out) : Válvula Antirretorno Cilíndrica Rosca - Rosca

MODELO	T1	T2	L	A1	A2	H	PESO
CVPF G01-G01	G 1/8	G 1/8	26.6	5.0	8.0	14	24.0
CVPF G02-G02	G 1/4	G 1/4	33.1	6.5	10.0	17	40.0
CVPF G03-G03	G 3/8	G 3/8	49.0	6.5	11.0	22	102.0
CVPF G04-G04	G 1/2	G 1/2	55.7	8.0	14.0	24	121.0



### CVPU : Válvula Antirretorno Cónica Tubo - Tubo

MODELO	D	P	L	B	PESO
CVPU04	4	10.5	42.3	15.7	5.6
CVPU06	6	12.5	47.5	17.0	8.4
CVPU08	8	14.8	56.4	19.1	13.4
CVPU10	10	23.0	65.2	20.3	16.4
CVPU12	12	25.0	73.0	23.3	31.2

**VÁLVULA REGULADOR CAUDAL ANTIRRETORNO PILOTADO CDC:**

Válvulas Antirretorno Unidireccionales. Al dar presión de pilotaje al otro lado de la válvula, entonces el aire fluye por el regulador en dirección al racor de tubo (orientable a 360°). Posicionamiento parada de un cilindro o bloqueo en caso de suinistro del aire, Permiten el arranque progresivo en circuito neumático, evitando golpes bruscos.



**PVSC: Regulador de caudal con válvula pilotada.**

Precisa regulación para un óptimo control del flujo de aire en el momento deseado. Compactos, precisos, conforman amplio ratio regulación. Bidireccionales: -OUT códigos normales compulsador azul, el aire se regula sóla mente de rosca a tubo. Permitir una parada emergente con opcional posición controlada por "A". (Esquema de más abajo). Proteger el deterioro del vástago del cilindro en parada.

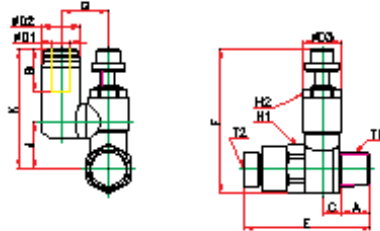

**PVSC : Válvula Antirretorno Pilotada Cónica Regulable Rosca - Tubo**

MODELO	D	A	T1	T2	B	D1	D2	D3	C	E	F/min	F/max	G	J	K	H1	H2	PESO
PVSC0601	06	8.0	R1/8	M5	17.0	6.0	12.6	12.1	8.0	35.4	43.6	48.4	16.1	14.9	38.9	12.0	10.0	37.1
PVSC0801	08	8.0	R1/8	M5	19.1	8.0	14.9	12.1	8.0	35.4	43.6	48.4	17.3	14.9	39.8	12.0	10.0	38.9
PVSC0602	06	10.5	R1/4	R1/8	17.0	6.0	12.6	15.4	7.6	42.0	55.4	60.4	19.4	18.4	44.3	17.0	13.0	72.1
PVSC0802	08	10.5	R1/4	R1/8	19.1	8.0	14.9	15.4	7.6	42.0	55.4	60.4	18.4	18.4	46.7	17.0	13.0	74.0
PVSC0803	08	11.4	R3/8	R1/8	19.1	8.0	15.1	20.3	9.6	49.7	58.4	63.4	23.4	21.4	50.7	19.0	17.0	121.8
PVSC1003	10	11.4	R3/8	R1/8	20.2	10.0	17.6	20.3	9.6	49.7	58.4	63.4	23.4	21.4	53.0	19.0	17.0	123.7
PVSC1203	12	11.4	R3/8	R1/8	22.7	12.0	20.6	20.3	9.6	49.7	58.4	63.4	23.4	21.4	54.8	19.0	17.0	127.5
PVSC1004	10	14.4	R1/2	R1/4	20.2	10.0	17.6	27.3	12.8	59.8	72.0	78.0	26.4	31.3	64.4	24.0	23.0	231.5
PVSC1204	12	14.4	R1/2	R1/4	22.7	12.0	20.6	27.3	12.8	59.8	72.0	78.0	26.4	31.3	67.2	24.0	23.0	235.5

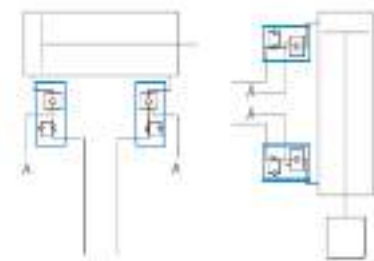
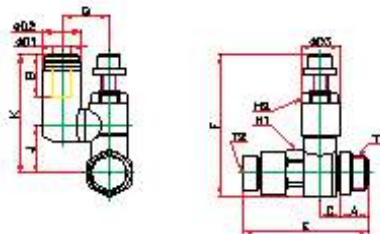

**PVSC-G : Válvula Antirretorno Pilotada Cilíndrica Regulable Rosca - Tubo**

MODELO	D	A	T1	T2	B	D1	D2	D3	C	E	F/min	F/max	G	J	K	H1	H2	PESO
PVSC06-G01	06	8.0	R1/8	M5	17.0	6.0	12.6	12.1	8.0	35.4	43.6	48.4	16.1	14.9	38.9	12.0	10.0	37.1
PVSC08-G01	08	8.0	R1/8	M5	19.1	8.0	14.9	12.1	8.0	35.4	43.6	48.4	17.3	14.9	39.8	12.0	10.0	38.9
PVSC06-G02	06	10.5	R1/4	R1/8	17.0	6.0	12.6	15.4	7.6	42.0	55.4	60.4	19.4	18.4	44.3	17.0	13.0	72.1
PVSC08-G02	08	10.5	R1/4	R1/8	19.1	8.0	14.9	15.4	7.6	42.0	55.4	60.4	18.4	18.4	46.7	17.0	13.0	74.0
PVSC08-G03	08	11.4	R3/8	R1/8	19.1	8.0	15.1	20.3	9.6	49.7	58.4	63.4	23.4	21.4	50.7	19.0	17.0	121.8
PVSC10-G03	10	11.4	R3/8	R1/8	20.2	10.0	17.6	20.3	9.6	49.7	58.4	63.4	23.4	21.4	53.0	19.0	17.0	123.7
PVSC12-G03	12	11.4	R3/8	R1/8	22.7	12.0	20.6	20.3	9.6	49.7	58.4	63.4	23.4	21.4	54.8	19.0	17.0	127.5
PVSC10-G04	10	14.4	R1/2	R1/4	20.2	10.0	17.6	27.3	12.8	59.8	72.0	78.0	26.4	31.3	64.4	24.0	23.0	231.5
PVSC12-G04	12	14.4	R1/2	R1/4	22.7	12.0	20.6	27.3	12.8	59.8	72.0	78.0	26.4	31.3	67.2	24.0	23.0	235.5

**PVSF : Válvula Antirretorno Pilotada Regulable Rosca M - Rosca H**

MODELO	T1	T2	T3	L2	E1	E2	PESO
PVSF01	R1/8	R1/8	M5	40,8	18,2	7,3	34,5
PVSF02	R1/8	R1/4	R1/8	48,9	26,5	9,5	74,6
PVSF03	R3/8	R3/8	R1/8	56,7	30,8	11,6	124,4
PVSF04	R1/2	R1/2	R1/4	70,6	38,7	14,0	207,2



## RACORES RAPIDOS POM P/AIRE Y FLUIDOS

Series CK; GCK; FCK.  
Ensamblados totalmente en plástico POM (Poliacetal)  
Tolerantes a productos químicos y a la corrosión.

Debido a su flexibilidad son racores resistentes para instalar en usos industriales donde hay vibraciones.  
Industria Química, Ferroviaria, Automoción, etc.

Pensados para trabar con tubo PUR (de las medidas abajo indicadas) o cualquier tubería flexible.

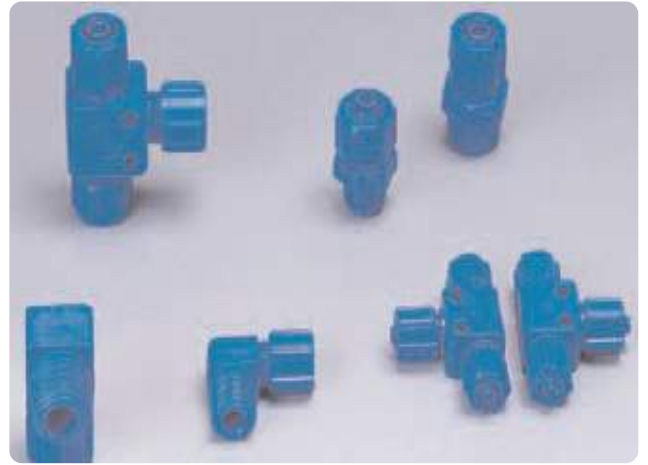

### METRIC - BSPT(R) CK 06-01

TWO TOUCH FITTING

CODE	Tube Dia		Thread Size	
	OD	ID	R(PT) THREAD	CODE
04	Ø4	Ø2.5		
06	Ø6	Ø4	01	R1/8
08	Ø8	Ø5.5	02	R1/4
10	Ø10	Ø6.5	03	R3/8
12	Ø12	Ø8	04	R1/2

#### Application

- A nut tightening pipe connection tool for devices that use pneumatic piping.

#### Features

- The connection method is not tightening and efficient in environments with vibration.
- Made from plastics to be semi-permanent, has good tolerance to corrosion and chemicals.
- Suited for low air pressure devices.

#### Specifications

- Fluid type: Air (no other gases or liquids)
- Working pressure: 0-150PSI / 0-9.9kgf/cm<sup>2</sup>(0-990kPa)
- Negative pressure: -29.5 in Hg / -150mmHg(-150Torr)
- Working temperature: 32-140° F / 0-60°C
- Applicable Tube: Polyurethane and Nylon

#### Structural Diagram

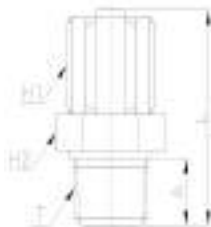
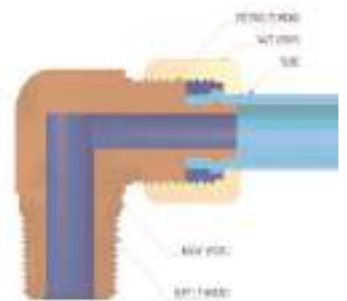

#### CK : Racor Rápido POM Recto

MODELO	D	T	L	A	H1	H2	PESO
CK06-01	6	R 1/8	27.5	7.0	12	13	2.7
CK06-02	6	R 1/4	30.5	9.0	12	15	4.3
CK08-01	8	R 1/8	29.5	9.0	14	14	3.6
CK08-02	8	R 1/4	29.0	9.0	14	15	4.6
CK08-03	8	R 3/8	31.7	10.2	14	19	6.5
CK10-02	10	R 1/4	33.4	9.2	17	17	6.1
CK10-03	10	R 3/8	34.4	10.2	17	19	7.5
CK12-02	12	R 1/4	39.0	9.2	19	17	7.8
CK12-03	12	R 3/8	41.2	10.2	19	19	8.7

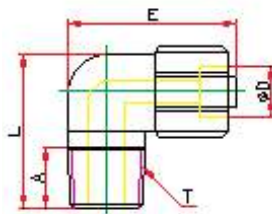

#### GCK : Racor Rápido POM Codo

MODELO	D	T	L	E	A	H	PESO
GCK06-01	6	R 1/8	24.5	26.0	7.0	12	4.1
GCK06-02	6	R 1/4	26.5	29.5	9.0	12	5.5
GCK08-01	8	R 1/8	24.5	25.5	8.0	14	4.8
GCK08-02	8	R 1/4	26.5	29.5	10.0	14	6.0
GCK08-03	8	R 3/8	27.5	32.5	11.0	14	9.2
GCK10-02	10	R 1/4	30.0	32.0	12.0	17	8.7
GCK10-03	10	R 3/8	31.0	34.7	12.0	17	10.8
GCK12-02	12	R 1/4	32.0	41.5	11.0	19	13.0
GCK12-03	12	R 3/8	34.0	41.5	12.0	19	14.4

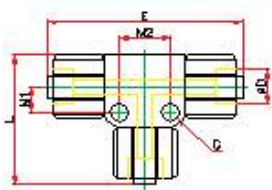

#### FCK : Racor Rápido POM "TE"

MODELO	D	L	E	C	M1	M2	H	PESO
FCK06	6	31.1	48.3	4.3	5.7	11.2	12	9.3
FCK08	8	32.0	48.0	4.3	6.6	12.2	14	11.9
FCK10	10	40.0	54.0	4.3	8.3	13.4	17	20.5
FCK12	12	47.7	68.0	4.3	9.3	13.7	19	27.7



## FLUIDFIT

### RACORES DE PLÁSTICO P/AGUA Y FLUIDOS.

Construcción en plástico POM (Acetal), pinza acero inoxidable SUS301, junta EPDM.

Los racores FLUIDFIT son de tipo Instantáneo y fáciles de montar.

Características: Buena resistencia a fluidos alimentarios como: agua, cerveza, lácticos, etc.

Cumple la normativa NSF, materiales no-tóxicos.

Temperatura de trabajo: -10°C a + 70°C

Presión de trabajo: 10 bar

Aplicaciones: Se utilizan para la conducción de fluidos en industria alimentaria en general: Agua potable, Ósmosis y agua sanitaria, zumos (consultar), bebidas de barril tipo sodas, cervezas, etc.

ISO 9001:2000 Aprobación NSF-ANSI Standard 51/61



Fitting for  
Potable Water,  
Drinks Dispense,  
Beverages

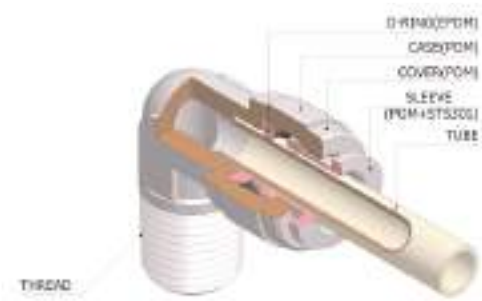

Maximum Torque Values  
for BSP, BSPT and NPT Plastic Threads

Threads	1/8	1/4	3/8	1/2
Max. Torque	1.5Nm	1.5Nm	3.0Nm	3.0Nm

Fluidfit  
www.fluidfit.com

#### HPC : Racor Instantáneo FLUIDFIT Recto Tubo a R.Macho cónica

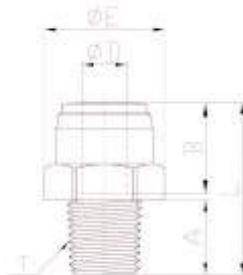

MODELO	D	T	A	B	E	H	L
HPC 06R01	06	1/8	9.1	16.1	18.5	17.0	26.2
HPC 06R02	06	1/4	13.1	16.1	18.5	17.0	26.8
HPC 08R01	08	1/8	9.1	17.5	21.0	19.0	28.1
HPC 08R02	08	1/4	13.1	17.5	21.0	19.0	30.7
HPC 10R03	10	3/8	13.5	20.1	23.2	21.0	28.8
HPC 10R04	10	1/2	16.3	20.1	24.4	22.0	32.3
HPC 12R03	12	3/8	13.5	24.7	26.5	24.0	32.2
HPC 12R04	12	1/2	16.3	24.7	26.5	24.0	34.5

#### HPC-G : Racor Instantáneo FLUIDFIT Recto Tubo a R.Macho Cilíndrica

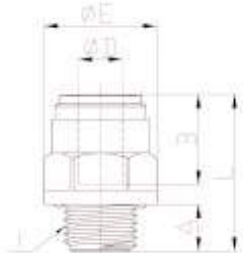

MODELO	D	T	A	B	E	H	L
HPC 06G01	06	1/8	9.1	16.1	18.5	17.0	26.2
HPC 06G02	06	1/4	13.1	16.1	18.5	17.0	26.8
HPC 08G01	08	1/8	9.1	17.5	21.0	19.0	28.1
HPC 08G02	08	1/4	13.1	17.5	21.0	19.0	30.7
HPC 10G03	10	3/8	13.5	20.1	23.2	21.0	28.8
HPC 10G04	10	1/2	16.3	20.1	24.4	22.0	32.3
HPC 12G03	12	3/8	13.5	24.7	26.5	24.0	32.2
HPC 12G04	12	1/2	16.3	24.7	26.5	24.0	34.5
HPC 15G04	15	1/2	12.5	29.4	28.8	26.0	43.9
HPC 22G05	22	3/4	14.5	33.8	37.0	33.0	51.0

#### HCF : Racor Instantáneo FLUIDFIT Recto Tubo a R.Hembra cilíndrica

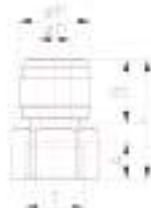

MODELO	D	P	T	L	A	B	H	E
HCF 06G01	06	17.6	1/8	27.1	6.0	16.1	17	19.2
HCF 06G02	06	17.6	1/4	29.1	8.5	16.1	19	21.5
HCF 08G01	08	17.6	1/8	27.5	6.0	17.5	17	19.2
HCF 08G02	08	17.6	1/4	29.5	8.5	17.5	19	21.5
HCF 10G03	10	23.0	3/8	37.0	9.0	20.1	24	27.3
HCF 12G04	12	23.0	1/2	41.7	12.5	24.7	27	30

**HCJ: Racor FLUIDFIT Recto Espiga Tubo a R.Macho Cónico**



MODELO	D	T	A	B	E	H	L
HCJ04-01	4	R 1/8	6,0	18,0	16,6	15	33,0
HCJ04-02	4	R 1/4	8,5	18,0	20,5	18	34,5
HCJ06-01	6	R 1/8	6,0	19,8	16,6	15	34,3
HCJ06-02	6	R 1/4	8,5	19,8	20,5	18	36,8
HCJ08-01	8	R 1/8	6,0	21,2	16,6	15	36,0
HCJ08-02	8	R 1/4	8,5	21,2	20,5	18	38,4
HCJ08-03	8	R 3/8	9,0	21,2	24,2	22	38,8
HCJ10-02	10	R 1/4	8,5	24,0	24,2	18	41,7
HCJ10-03	10	R 3/8	9,0	24,0	24,2	22	41,7
HCJ10-04	10	R 1/2	12,5	24,0	28,5	26	44,8
HCJ12-03	12	R 3/8	9,0	28,0	24,2	22	45,6
HCJ12-04	12	R 1/2	12,5	28,0	28,5	26	48,8

**HCJ-G: Racor FLUIDFIT Recto Espiga Tubo a R.Macho Cilíndrico**



MODELO	D	T	A	B	E	H	L
HCJ04-G01	4	R 1/8	5,0	18,0	16,6	15	33,0
HCJ04-G02	4	R 1/4	6,5	18,0	20,5	18	33,0
HCJ06-G01	6	R 1/8	5,0	19,8	16,6	15	34,3
HCJ06-G02	6	R 1/4	6,5	19,8	20,5	18	36,8
HCJ08-G01	8	R 1/8	5,0	21,2	16,6	15	36,0
HCJ08-G02	8	R 1/4	6,5	21,2	20,5	18	38,4
HCJ08-G03	8	R 3/8	7,5	21,2	24,2	22	38,8
HCJ10-G02	10	R 1/4	6,5	24,0	20,5	18	41,7
HCJ10-G03	10	R 3/8	7,5	24,0	24,2	22	41,7
HCJ10-G04	10	R 1/2	9,5	24,0	28,5	26	44,8
HCJ12-G03	12	R 3/8	7,5	28,0	24,2	22	45,6
HCJ12-G04	12	R 1/2	9,5	28,0	28,5	26	48,8

**HUC : Racor Instantáneo FLUIDFIT Unión (y Reducción) Tubo-Tubo**

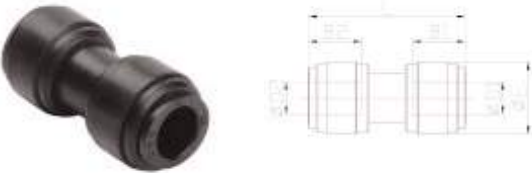

MODELO	D1	D2	B1	B2	E	L
HUC0404	4	4	14,8	14,8	13,3	31,9
HUC0604	6	4	14,8	14,8	13,3	31,9
HUC0606	6	6	16,1	16,1	15,1	35,3
HUC0806	8	6	16,1	16,1	15,1	35,3
HUC0808	8	8	17,5	17,5	17,6	38,2
HUC1006	10	6	17,5	17,5	17,6	38,2
HUC1008	10	8	20,1	20,1	20,1	42,7
HUC1010	10	10	20,1	20,1	20,1	42,7
HUC1210	12	10	20,1	20,1	20,1	42,7
HUC1212	12	12	23,7	24,7	24,7	52,4
HUC1515	15	15				
HUC2222	22	22				

**HUL : Racor Instantáneo FLUIDFIT Codo unión Tubo**



MODELO	D1	D2	B1	B2	E	H	L
HUL0404	4	4	14,8	14,8	13,3	24,6	24,6
HUL0606	6	6	16,1	16,1	15,1	27,6	27,6
HUL0808	8	8	17,5	17,5	17,6	30,7	30,7
HUL1010	10	10	20,1	20,1	20,1	35,8	35,8
HUL1212	12	12	23,7	24,7	24,7	43,0	43,0
HUL1515	15	15					
HUL2222	22	22					

**HUT : Racor Instantáneo FLUIDFIT "TE" unión Tubo**



MODELO	D1	D2	B1	B2	E	H	L
HUT0404	4	4	14,8	14,8	13,3	24,6	36,0
HUT0606	6	6	16,1	16,1	15,1	27,6	40,2
HUT0808	8	8	17,5	17,5	17,6	30,7	43,8
HUT1010	10	10	20,1	20,1	20,1	35,8	51,6
HUT1212	12	12	23,7	24,7	24,7	43,0	63,4
HUT1515	15	15					
HUT2222	22	22					

**HUY : Racor FLUIDFIT "Y" Unión Tubo**



MODELO	D1	D2	B1	B2	P1	P2	L	J
HUY0404	4	4	14,8	14,8	13,8	13,8	33,7	13,5
HUY0606	6	6	16,1	16,1	15,5	15,5	38,8	15,5
HUY0808	8	8	17,5	17,5	17,6	17,6	41,0	17,6
HUY1010	10	10	20,1	20,1	20,1	20,1	46,2	20,0
HUY1212	12	12	23,7	24,7	23,0	23,0	56,4	23,0

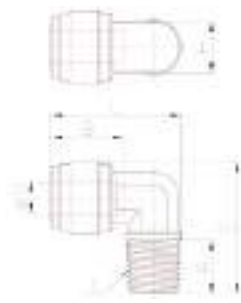

**HPL : Racor Instantáneo FLUIDFIT Codo Tubo a R.Macho cónico**

MODELO	D	T	A	B	E	H	L
HPL 0601	06	1/8	9.1	16.1	25.6	10.0	25.
HPL 0602	06	1/4	13.1	16.1	30.7	10.0	27.0
HPL 0802	08	1/4	13.1	17.5	32.3	13.0	31.5
HPL 1003	10	3/8	13.5	20.1	35.7	14.0	33.9
HPL 1204	12	1/2	16.3	24.7	41.5	17.0	40.6



**HLJ : Válvula Antirretorno Inst. FLUIDFIT Unión Tubo**

MODELO	D1	D2	P	A	P	E	L	O	CANT
HLJ 0404	04	04	13.2	18.0	14.7	30.1	21.9	2.5	100
HLJ 0606	06	06	15.5	21.0	16.1	34.8	25.1	3.7	100
HLJ 0608	06	08	17.6	21.0	17.5	36.8	26.0	4.7	100
HLJ 0808	08	08	17.6	22.5	17.5	38.3	27.7	5.3	50
HLJ 1006	10	06	20.0	24.8	16.1	43.2	30.6	7.8	50
HLJ 1008	10	08	20.0	24.8	17.5	43.2	31.0	8.2	50
HLJ 1010	10	10	20.0	24.8	20.1	43.2	31.3	7.4	50
HLJ 1212	12	12	23.6	29.5	24.7	51.2	39.0	12.6	25

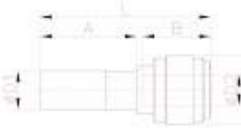

**HGJ : Válvula cierre Inst. FLUIDFIT Unión Tubo**

MODELO	D1-2	B1-2	P1-2	L1	L2	E12	E2	H
HGJ 0604	06	04	10.5	36.7	21.0	14.7	2.4	100
HGJ 0804	08	04	15.5	40.4	22.5	14.7	3.7	100
HGJ 0806	08	06	10.5	40.6	22.5	16.1	3.5	100
HGJ 1006	10	06	12.5	43.4	24.8	16.1	5.2	50
HGJ 1008	10	08	12.5	43.8	24.8	17.5	5.1	50
HGJ 1208	12	08	20.0	51.3	29.5	17.5	7.3	-
HGJ 1210	12	10	20.0	51.6	29.5	20.1	6.9	-

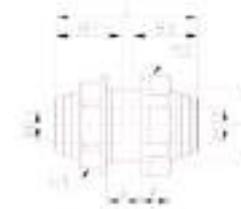

**HMM : Válvula Antirretorno Inst. FLUIDFIT Unión Tubo**

MODELO	D1	D2	A	L	F	A	B1	B2	H1	H2	CANT
HMM 0404	04	04	M15*1.5p	32.4	6.5	8.1	14.7	14.7	17	18	50
HMM 0604	06	04	M17*1.5p	35.5	7.0	9.4	16.1	14.7	19	21	50
HMM 0606	06	06	M17*1.5p	35.7	7.0	9.4	16.1	16.1	19	21	50
HMM 0806	08	06	M20*1.75p	38.1	8.0	9.4	17.5	16.1	21	25.5	25
HMM 0808	08	08	M20*1.75p	38.5	8.0	9.4	17.5	17.5	21	25.5	25
HMM 1010	10	10	M24*1.75p	42.2	8.5	11.1	20.1	20.1	24	28.5	25
HMM 1212	12	12	M27*2.0p	51.4	9.0	16.4	24.7	24.7	27	31	20

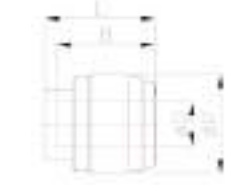

**HPF : Válvula cierre Inst. FLUIDFIT Unión Tubo**

MODELO	D	P	L	B	CANT
HPF 06	6	15.5	18.9	16.1	100
HPF 08	8	17.6	19.5	17.5	100
HPF 10	10	20.0	22.1	20.1	50
HPF 12	12	23.0	26.7	24.7	50

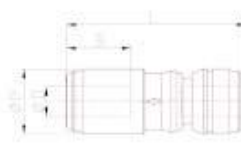

**HCVU : Válvula Antirretorno Inst. FLUIDFIT Unión Tubo**

MODELO	D	P	L	B
HCVU0606	6	15,5	45,5	16,1
HCVU0808	8	17,6	48,6	17,5
HCVU1010	10	20,0	57,6	19,4
HCVU1212	12	23,6	67,5	23,9



**HCP : Pinza bloqueo pulsador FLUIDFIT**

MODELO	D	E	C	L	H	J	K	BOX
HCP 04	04	6.2	10.2	11.0	2.8	4.3	1.1	0.09
HCP 06	06	8.0	11.6	11.6	3.1	6.4	1.3	0.12
HCP 08	08	9.6	13.5	13.9	3.3	7.3	1.4	0.16
HCP 10	10	11.8	16.0	16.4	3.4	9.2	1.4	0.23
HCP 12	12	14.4	19.0	19.0	3.6	11.1	1.4	0.30

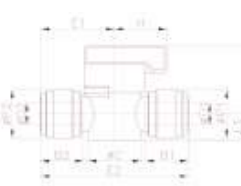

**HBVU : Válvula cierre Inst. FLUIDFIT Unión Tubo**

MODELO	D1-2	B1-2	P1-2	L1	L2	E12	E2	H
HBVU 0606	06	16.1	15.5	9.5	34.5	25.9	51.7	19.0
HBVU 0808	08	17.5	17.6	9.5	34.5	26.8	53.5	19.0
HBVU 1010	10	20.1	20.0	12.5	42.3	31.5	63.0	26.3
HBVU 1212	12	23.7	23.0	12.5	42.3	35.2	70.4	26.3

## FLUIDFIT RACORES TUBO EN PULGADAS (INCH) ROSCA NPT EN COLOR MARFIL

RACORES PARA TUBERIAS EN PULGADAS (EXT) Y ROSCAS TIPO NPT.

Fluid type	Water, Beverages	
Tube type	Polyethylene(PE), Polyamide(PAI) and Polyurethane(PU)	
Temperature	Working Pressure	
	4mm-8mm	10mm-12mm
1°C	18Bar	10Bar
25°C	18Bar	10Bar
70°C	10Bar	7Bar

Maximum Torque Values for BSP, BSPT and NPT Plastic Threads

Threads	1/8	1/4	3/8	1/2
Max. Torque	1.5Nm	1.5Nm	3.0Nm	3.0Nm

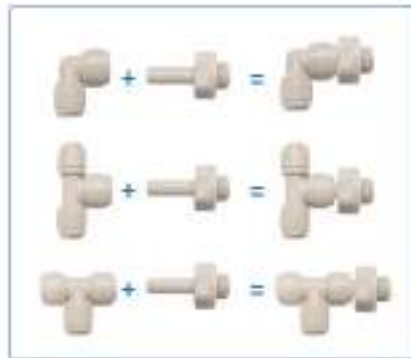

HPC Recto T - R

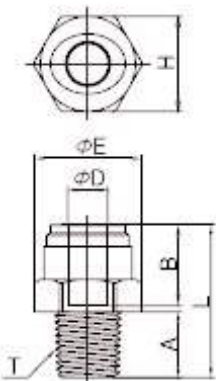

MODEL

MODEL	ØD	T (NPTF)	A	B TUBE DEEP	ØE	H (INCH)	L	WEIGHT (g)	BOX (EA)
HPC 5/32-N01	5/32	1/8	9.1	14.7	17.8	15.8(5/8)	22.2	3.2	100
HPC 5/32-N02	5/32	1/4	13.2	14.7	17.8	15.8(5/8)	25.3	4.3	100
HPC 3/16-N01	3/16	1/8	9.1	15.0	17.8	15.8(5/8)	22.4	3.1	100
HPC 3/16-N02	3/16	1/4	13.2	15.0	17.8	15.8(5/8)	25.5	4.2	100
HPC 1/4-N01	1/4	1/8	9.1	16.9	17.8	15.8(5/8)	27.0	3.9	100
HPC 1/4-N02	1/4	1/4	13.2	16.9	17.8	15.8(5/8)	27.0	4.3	100
HPC 1/4-N03	1/4	3/8	13.8	16.9	21.4	19.0(3/4)	26.1	6.1	50
HPC 5/16-N01	5/16	1/8	9.1	17.5	21.4	19.0(3/4)	28.4	5.8	100
HPC 5/16-N02	5/16	1/4	13.2	17.5	21.4	19.0(3/4)	27.9	5.2	50
HPC 5/16-N03	5/16	3/8	13.8	17.5	21.4	19.0(3/4)	26.5	6.0	50
HPC 5/16-N04	5/16	1/2	17.8	17.5	25	22.2(7/8)	33.5	11.5	50
HPC 3/8-N01	3/8	1/8	9.1	20.2	23	20.8(13/16)	30.4	6.7	50
HPC 3/8-N02	3/8	1/4	13.2	20.2	23	20.8(13/16)	34.3	7.9	50
HPC 3/8-N03	3/8	3/8	13.8	20.2	23	20.8(13/16)	29.9	7.5	50
HPC 3/8-N04	3/8	1/2	17.8	20.2	25	22.2(7/8)	33.9	11.0	50
HPC 1/2-N03	1/2	3/8	13.8	25.1	27.4	24.3(1/2)	38.4	11.7	50
HPC 1/2-N04	1/2	1/2	17.8	25.1	27.4	24.3(1/2)	37.9	12.7	50

HCF Hembra R-T

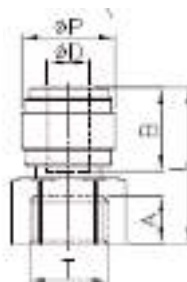

MODEL

MODEL	ØD	ØP	T (NPTF)	L	A	B TUBE DEEP	H(HEX)	ØE	WEIGHT (g)
HCF 1/4-N01	1/4	15.5	1/8	30.9	11.5	16.9	17	19	6.1
HCF 1/4-N02	1/4	15.5	1/4	30.9	11.5	16.9	19	21.5	6.5
HCF 3/8-N02	3/8	20	1/4	34.2	11.5	20.2	19	21.5	8.5

HCJ Espiga T-R



MODEL

MODEL	ØD	T (NPTF)	A	B	ØE	H(HEX)	L	WEIGHT (g)	BOX (EA)
HCJ 5/32-N01	5/32	1/8	9.1	18.0	14.1	12.7(1/2)	33.1	1.9	100
HCJ 5/32-N02	5/32	1/4	13.2	18.0	17.8	15.8(5/8)	37.2	3.6	100
HCJ 3/16-N01	3/16	1/8	9.1	18.0	14.1	12.7(1/2)	33.1	2.0	100
HCJ 1/4-N01	1/4	1/8	9.1	19.0	14.1	12.7(1/2)	34.1	2.1	100
HCJ 1/4-N02	1/4	1/4	13.2	19.0	17.8	15.8(5/8)	38.2	3.8	100
HCJ 5/16-N01	5/16	1/8	9.1	20.0	14.1	12.7(1/2)	35.1	2.8	100
HCJ 5/16-N02	5/16	1/4	13.2	20.0	17.8	15.8(5/8)	39.2	3.9	50
HCJ 5/16-N03	5/16	3/8	13.8	20.0	21.5	19.0(3/4)	40.3	5.9	50
HCJ 3/8-N02	3/8	1/4	13.2	23.0	17.8	15.8(5/8)	42.2	4.5	50
HCJ 3/8-N03	3/8	3/8	13.8	23.0	21.5	19.0(3/4)	43.3	6.5	50
HCJ 1/2-N03	1/2	3/8	13.8	27.0	21.5	19.0(3/4)	47.3	6.9	50
HCJ 1/2-N04	1/2	1/2	17.8	27.0	26.8	23.8(15/16)	51.3	11.4	25

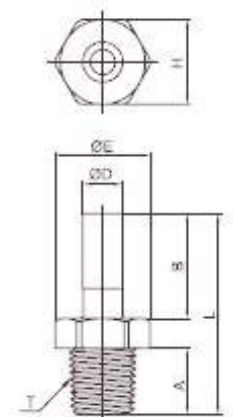

## HPL Codo T - R



MODEL	ØD	ØP	T (NPTF)	A	B TUBE DEEP	E	H (INCH)	L	WEIGHT (g)	BOX (EA)
HPL 5/32-N01	5/32	15.5	1/8	9.1	14.7	26.4	11.0(7/16)	25.4	4.9	100
HPL 3/16-N01	3/16	15.5	1/8	9.1	15	26.4	11.0(7/16)	25.6	4.7	100
HPL 1/4-N01	1/4	15.5	1/8	9.1	16.9	26.4	11.0(7/16)	25.6	4.2	100
HPL 1/4-N02	1/4	15.5	1/4	13.2	16.9	31.9	11.0(7/16)	27.0	5.7	50
HPL 1/4-N03	1/4	15.5	3/8	13.8	16.9	32.7	11.0(7/16)	28.9	7.1	50
HPL 5/16-N02	5/16	20	1/4	13.2	17.5	35.2	14.3(9/16)	31.4	9.0	50
HPL 5/16-N03	5/16	20	3/8	13.8	17.5	35.8	14.3(9/16)	33.5	10.3	50
HPL 3/8-N02	3/8	20	1/4	13.2	20.2	35.2	14.3(9/16)	31.8	8.6	50
HPL 3/8-N03	3/8	20	3/8	13.8	20.2	35.8	14.3(9/16)	33.9	9.9	50
HPL 1/2-N03	1/2	23.6	3/8	13.8	25.1	39.3	17.4(11/16)	39.7	13.3	25
HPL 1/2-N04	1/2	23.6	1/2	17.8	25.1	43.3	17.4(11/16)	41.5	16.2	25

## HUC Unión/Reducción



MODEL	ØD1	ØD2	B1 TUBE DEEP	B2 TUBE DEEP	ØE	L	WEIGHT (g)	BOX (EA)
HUC 5/32-5/32	5/32	5/32	14.7	14.7	13.2	31.8	3.8	100
HUC 3/16-3/16	3/16	3/16	15.0	15.0	13.8	32.5	4.0	100
HUC 1/4-1/4	1/4	1/4	16.9	16.9	15.5	36.2	5.2	100
HUC 5/16-5/32	5/16	5/32	17.5	14.7	17.8	36.6	6.5	50
HUC 5/16-1/4	5/16	1/4	17.5	16.9	17.8	36.8	6.0	50
HUC 5/16-5/16	5/16	5/16	17.5	17.5	17.8	38.2	6.9	50
HUC 3/8-1/4	3/8	1/4	20.2	16.9	20	42.1	9.9	50
HUC 3/8-5/16	3/8	5/16	20.2	17.5	20	42.5	9.9	50
HUC 3/8-3/8	3/8	3/8	20.2	20.2	20	42.9	9.7	50
HUC 1/2-5/16	1/2	5/16	25.1	17.5	23.6	52.0	16.7	25
HUC 1/2-3/8	1/2	3/8	25.1	20.2	23.6	52.4	16.3	25
HUC 1/2-1/2	1/2	1/2	25.1	25.1	23.6	53.2	14.6	25

## HUL Codo Unión/Red.



MODEL	ØD1	ØD2	B1 TUBE DEEP	B2 TUBE DEEP	ØE1	ØE2	L	H	WEIGHT (g)	BOX (EA)
HUL 5/32-5/32	5/32	5/32	14.7	14.7	13.2	13.2	24.5	24.5	4.0	100
HUL 3/16-3/16	3/16	3/16	15.0	15.0	13.8	13.8	25.5	25.5	4.3	100
HUL 1/4-1/4	1/4	1/4	16.9	16.9	15.5	15.5	28.8	28.8	5.5	100
HUL 5/16-5/32	5/16	5/32	17.5	14.7	17.6	13.2	28.3	29.7	5.9	50
HUL 5/16-1/4	5/16	1/4	17.5	16.9	17.6	17.6	30.7	30.3	7.6	50
HUL 5/16-5/16	5/16	5/16	17.5	17.5	17.6	17.6	30.7	30.7	7.5	50
HUL 3/8-5/16	3/8	5/16	20.2	17.5	20	20	35.9	35.5	11.1	50
HUL 3/8-3/8	3/8	3/8	20.2	20.2	20	20	35.9	35.9	10.6	50
HUL 1/2-3/8	1/2	3/8	25.1	20.2	23	23	43.4	42.6	17.5	25
HUL 1/2-1/2	1/2	1/2	25.1	25.1	23	23	43.4	43.4	16.7	25

## HUT - TE unión



MODEL	ØD1	ØD2	B1 TUBE DEEP	B2 TUBE DEEP	ØE	H	L	WEIGHT (g)	BOX (EA)
HUT 5/32-5/32	5/32	5/32	14.7	14.7	13.2	24.5	35.8	5.7	100
HUT 3/16-3/16	3/16	3/16	15.0	15.0	13.8	25.5	37.2	6.2	100
HUT 1/4-1/4	1/4	1/4	16.9	16.9	15.5	28.8	42.0	8.1	50
HUT 5/16-5/16	5/16	5/16	17.5	17.5	17.6	30.7	43.8	10.6	50
HUT 3/8-3/8	3/8	3/8	20.2	20.2	20	35.9	51.8	15.4	25
HUT 1/2-1/2	1/2	1/2	25.1	25.1	23	43.4	63.8	23.2	20

## HUY Racor Y



MODEL	ØD1	ØD2	B1 TUBE DEEP	B2 TUBE DEEP	ØP1	ØP2	L	J	ØC	WEIGHT (g)	BOX (EA)
HUY 5/32-5/32	5/32	5/32	14.7	14.7	13.8	13.8	33.7	13.5	3.3	6.7	100
HUY 3/16-3/16	3/16	3/16	15.0	15.0	13.8	13.8	34.1	13.5	3.3	6.8	50
HUY 1/4-1/4	1/4	1/4	16.9	16.9	15.5	15.5	38.8	15.5	3.3	8.8	50
HUY 5/16-5/16	5/16	5/16	17.5	17.5	17.6	17.6	41.0	17.6	4.5	11.8	50
HUY 3/8-3/8	3/8	3/8	20.2	20.2	20	20	46.4	20.0	4.5	16.7	25
HUY 1/2-1/2	1/2	1/2	25.1	25.1	23	23	56.8	23.0	4.5	25.1	20

## HLJ Codo Espiga-T

Stem Elbow



MODEL	ØD1	ØD2	ØP	A	B2 TUBE DEEP	E	L	WEIGHT (g)	BOX (EA)
HLJ 5/32-5/32	5/32	5/32	13.2	18.0	14.7	30.1	21.9	2.5	100
HLJ 3/16-3/16	3/16	3/16	13.8	18.5	15.0	31.4	22.5	2.9	100
HLJ 1/4-1/4	1/4	1/4	15.5	21.0	16.9	34.8	25.1	3.7	100
HLJ 5/16-5/16	5/16	5/16	17.6	22.5	17.5	38.3	27.7	5.4	50
HLJ 3/8-1/4	3/8	1/4	15.5	24.8	16.9	38.6	25.1	4.5	50
HLJ 3/8-5/16	3/8	5/16	20.0	24.8	17.5	43.2	31.0	8.1	50
HLJ 3/8-3/8	3/8	3/8	20.0	24.8	20.2	43.2	31.4	7.9	50
HLJ 1/2-1/2	1/2	1/2	23.6	29.5	25.1	51.2	39.2	12.7	25

## HGJ Espiga - Tubo

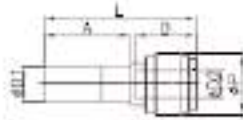

MODEL	ØD1	ØD2	ØP	L	A	B	WEIGHT (g)	BOX (EA)
HGJ 1/4-5/32	1/4	5/32	13.2	36.7	21	14.7	2.4	100
HGJ 5/16-1/4	5/16	1/4	15.5	40.8	22.5	16.9	3.4	100
HGJ 3/8-1/4	3/8	1/4	17.6	43.9	24.8	16.9	4.7	50
HGJ 3/8-5/16	3/8	5/16	17.6	44.3	24.8	17.5	4.6	50
HGJ 1/2-3/8	1/2	3/8	20	51.7	29.5	20.2	7.1	50

## HMM Pasamuros

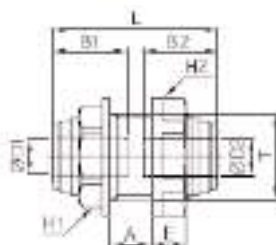

MODEL	ØD1	ØD2	T	L	E	A	B1 TUBE DEEP	B2 TUBE DEEP	H1 (Hex)	H2 (Hex)	WEIGHT (g)	BOX (EA)
HMM 5/32-5/32	5/32	5/32	M15×1.5p	32.4	6.5	8.1	14.7	14.7	17	18	6.9	50
HMM 1/4-1/4	1/4	1/4	M17×1.5p	35.7	7.0	9.4	16.9	16.9	19	21	9.4	50
HMM 1/4-3/8	1/4	3/8	M24×1.75p	47.9	8.5	11.1	16.9	20.2	24	28.5	20.9	25
HMM 5/16-5/16	5/16	5/16	M20×1.75p	38.5	8.0	9.4	17.5	17.5	21	25.5	14.2	25
HMM 3/8-3/8	3/8	3/8	M24×1.75p	42.4	8.5	11.1	20.2	20.2	24	28.5	20.1	25
HMM 1/2-1/2	1/2	1/2	M27×2.0p	51.8	9.0	16.4	25.1	25.1	27	31	27.6	20

### HPF Tapón Hembra



MODEL	ØD	ØP	L	B	WEIGHT (g)	BOX (EA)
HPF 1/4	1/4	15.5	18.9	16.9	2.7	-
HPF 5/16	5/16	17.6	19.5	17.5	3.6	-
HPF 3/8	3/8	20	22.2	20.2	5.0	-
HPF 1/2	1/2	23	26.9	24.9	7.0	-

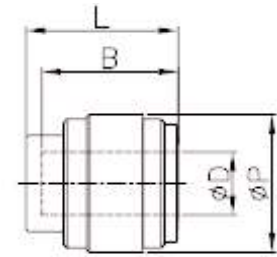

### HPP Tapón Macho



MODEL	ØD	ØP	L	A	WEIGHT (g)	BOX (EA)
HPP 5/32	5/32	13	22.5	19.0	0.8	200
HPP 3/16	3/16	13	22.5	19.0	0.9	200
HPP 1/4	1/4	13	24.5	21.0	1.2	200
HPP 5/16	5/16	16	26.5	23.0	1.8	100
HPP 3/8	3/8	18	30.0	26.0	2.7	100
HPP 1/2	1/2	21.5	34.0	30.0	4.4	100

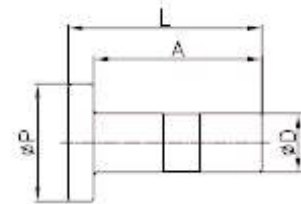

### HCVU V. antirretorno



MODEL	ØD	ØP	L	B TUBE DEEP	WEIGHT (g)	BOX (EA)
HCVU 1/4-1/4	1/4	15.5	45.5	16.1	7.4	50
HCVU 5/16-5/16	5/16	17.6	48.6	17.5	10.0	50
HCVU 3/8-3/8	3/8	20	57.8	19.5	15.0	25
HCVU 1/2-1/2	1/2	23.6	67.9	24.1	21.5	25

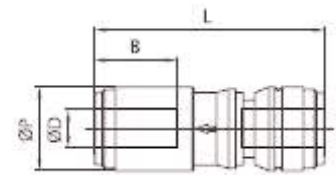

### HCP Pinza bloqueo



MODEL	ØD TUBE	ØC	E	L	H	J	K	WEIGHT (g)	BOX (EA)
HCP 5/32	5/32	6.2	10.2	11.0	2.8	4.3	1.1	0.09	1000
HCP 3/16	3/16	6.2	10.2	11.0	2.8	4.3	1.1	0.09	1000
HCP 1/4	1/4	8	11.6	11.6	3.1	6.4	1.3	0.12	1000
HCP 5/16	5/16	9.6	13.5	13.9	3.3	7.3	1.4	0.16	1000
HCP 3/8	3/8	11.8	16.0	16.4	3.4	9.2	1.4	0.23	1000
HCP 1/2	1/2	14.4	19.0	19.0	3.6	11.1	1.4	0.3	1000

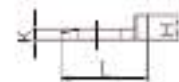

### HBVU Válvula cierre



MODEL	ØD1	ØD2	B1	B2	ØP1	ØP2	L1	L2	E1	E2	H	ØC
HBVU 1/4-1/4	1/4	1/4	16.1	16.1	15.5	15.5	9.5	34.5	25.9	51.7	19	19.2
HBVU 5/16-5/16	5/16	5/16	17.5	17.5	17.6	17.6	9.5	34.5	26.8	53.5	19	19.2
HBVU 3/8-3/8	3/8	3/8	20.2	20.2	20	20	12.5	42.3	31.6	63.2	26.3	24.2
HBVU 1/2-1/2	1/2	1/2	23.9	23.9	23	23	12.5	42.3	35.4	70.8	26.3	24.2



### HSLB Regul. caudal

#### Metric



MODEL	ØD	ØP	T	L1	L2 MIN	L2 MAX	E	A	B	H (HEX)	WEIGHT (g)
HSLB 0806	6	15.5	M12xP1.0	22.2	57.1	61.3	22.2	5.0	16.1	16	28.7



#### Inch



MODEL	ØD	ØP	T	L1	L2 MIN	L2 MAX	E	A	B	H (HEX)	WEIGHT (g)
HSLB 1/4-1/4	1/4	15.5	M12xP1.0	22.2	57.1	61.3	22.2	5.0	16.9	16	28.7

**RACORES INSTANTÁNEOS de Acero Inoxidable CdA:**

Totalmente fabricados en Acero Inox. Aisi 316. Pulsador circular. Junta de estanqueidad FKM (Viton). Pinza Inoxidable. Presión máx. 16 bar. Temp.-40°C a +130°C. Rosca cónica o cilíndrica c/tórica FKM. Óptimos para tubo de PTFE, PVDF, FEP, PE y otros Usados para la Ind. Química, Alimentaria, Farmacéutica, Naval. Resistentes a casi todo (consultar compatibilidades). Más figuras a consultar.

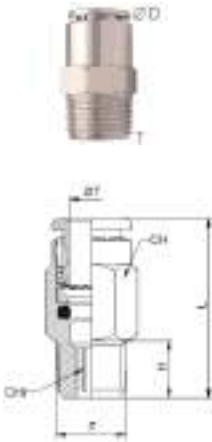

**INOXMC:**  
Racor Instantáneo Inox Recto Cónico  
(Posibilidad Rosca cilíndrica INOXMC-G)

MODELO	T	F	H	L	CH	CHI
INOXMC0401	04	1/8"	8	19,5	10	2,5
INOXMC0601	06	1/8"	11	24,8	11	4
INOXMC0602	06	1/4"	11	23,8	14	4
INOXMC0801	08	1/8"	8	28,0	13	5
INOXMC0802	08	1/4"	11	24,0	14	6
INOXMC1002	10	1/4"	11	28,9	17	7
INOXMC1003	10	3/8"	11,5	29,4	17	8
INOXMC1203	12	3/8"	11,5	32,0	19	10
INOXMC1204	12	1/2"	14	31,3	22	10



**INOXML:**  
Inst. Inox Codo Fijo Cónico  
(Posibilidad Orientable R.Cilíndrica)

MODELO	T	F	A	H	L	L1	CH
INOXML0401	04	1/8"	11	8	17,7	18,6	13
INOXML0601	06	1/8"	11	8	19,8	18,6	13
INOXML0602	06	1/4"	11	11	22,1	23,5	14
INOXML0801	08	1/8"	13	8	23	20,5	13
INOXML0802	08	1/4"	13	11	23	23,5	14
INOXML1002	10	1/4"	16	11	26,4	25,5	14
INOXML1003	10	3/8"	16	11,5	26,4	26,5	17
INOXML1203	12	3/8"	19	11,5	28,9	28,1	17
INOXML1204	12	1/2"	19	14	28,9	31,1	22



**INOXMUC:**  
Racor Inox. Inst. recto unión

MODELO	T	A	B	L
INOXMUC04	4	3	11	32
INOXMUC06	6	5	13	36,1
INOXMUC08	8	7	15	38
INOXMUC10	10	9	18	42,3
INOXMUC12	12	11	21	45,8

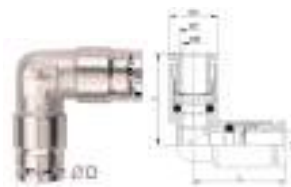

**INOXMUL:**  
Racor metal Inst. codo unión

	T	A	B	L
INOXMUL04	4	9	3	17,3
INOXMUL06	6	11	5	20,6
INOXMUL08	8	13	7	23
INOXMUL10	10	16	8	26,4
INOXMUL12	12	19	10	28,9
INOXMUL14	14	21	12	31,5



**INOXMUT:**  
Racor INOX. Inst. "TE" unión

MODELO	T	L	CH	CH1
INOXMUT04	4	9	3	17,3
INOXMUT06	6	11	5	20,6
INOXMUT08	8	13	7	23
INOXMUT10	10	16	8	26,4
INOXMUT12	12	19	10	28,9



**INOXMT:**  
Racor Inst. INOX "T" Orientable Cónica

MODELO	T	F	A	H	L	L1	CH
INOXMT0401	04	1/8"	11	8	17,3	18,6	13
INOXMT0601	06	1/8"	11	8	19,8	18,6	13
INOXMT0602	06	1/4"	11	11	22,1	23,5	14
INOXMT0801	08	1/8"	13	8	23	20,5	13
INOXMT0802	08	1/4"	13	11	23	23,5	14
INOXMT1002	10	1/4"	16	11	26,4	25,5	14
INOXMT1003	10	3/8"	16	11,5	26,4	26,5	17
INOXMT1203	12	3/8"					
INOXMT1204	12	1/2"					



**INOXMM:**  
Racor Instantáneo Inox. Pasamuros

MODELO	T	M	B	L	Lmax
INOXMM04	04	M11	3	32	8
INOXMM06	06	M14	5	36,1	8
INOXMM08	08	M16	7	38	10
INOXMM10	10	M18	9	42,3	12
INOXMM12	12	M22	11	45,8	17



**INOXMLG:**  
Inst. Inox Codo Giratorio Cilíndrico

MODELO	T	F	A	H	L	L1	CH
INOXML0401	04	1/8"	11	8	17,7	18,6	13
INOXML0601	06	1/8"	11	8	19,8	18,6	13
INOXML0602	06	1/4"	11	11	22,1	23,5	14
INOXML0801	08	1/8"	13	8	23	20,5	13
INOXML0802	08	1/4"	13	11	23	23,5	14
INOXML1002	10	1/4"	16	11	26,4	25,5	14
INOXML1003	10	3/8"	16	11,5	26,4	26,5	17
INOXML1203	12	3/8"	19	11,5	28,9	28,1	17
INOXML1204	12	1/2"	19	14	28,9	31,1	22



**RACORES CdA INSTANTÁNEOS METÁLICOS :**

Totalmente fabricados en latón cromado BRASS. Pulsador circular. Junta de estanqueidad NBR. Pinza Inoxidable SUS316. Presión máx. 16 bar. Temp.-15°C a +80°C. Rosca M5 paso 0,8. Rosca cónica teflonada o cilíndrica c/tórica. Óptimos para tubo de poliamida; polietileno y otros tubos rígidos. Usados para la soldadura. Resistentes al agua, grasa y aceites.

**MC: Racor Instantáneo Metálico Recto Cónico**

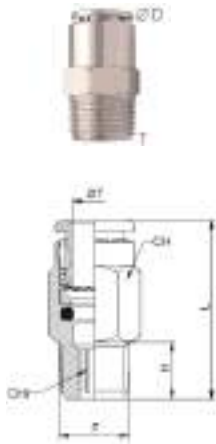

	T	F	H	L	CH	CHI
MC04-M5	04	M5	4	20,5	9	2,5
MC04-01,	04	1/8"	8	19,5	10	2,5
MC04-02,	04	1/4"	11	21,5	14	2,5
MC06-M5	06	M5	4	23,8	11	2,5
MC06-01,	06	1/8"	11	24,8	11	4
MC06-02,	06	1/4"	11	23,8	14	4
MC08-01,	08	1/8"	8	28	13	5
MC08-02,	08	1/4"	11	24	14	6
MC08-03,	08	3/8"	11,5	24,5	17	6
MC10-02,	10	1/4"	11	28,9	17	7
MC10-03,	10	3/8"	11,5	29,4	17	8
MC10-04,	10	1/2"	14	29,4	22	8
MC12-02,	12	1/4"	11	35,5	19	7
MC12-03,	12	3/8"	11,5	32	19	10
MC12-04,	12	1/2"	14	31,3	22	10
MC14-03,	14	3/8"	11,5	37,5	21	10
MC14-04,	14	1/2"	14	35	22	10

**MC-G: Racor Inst. Metálico Recto Cilíndrico**



	T	F	A	B	H	L	CH	CHI
MC04-G01,	04	1/8"	13,5	2,6	5,5	19,5	9	2,5
MC04-G02,	04	1/4"	17	2,6	6,5	19,5	9	2,5
MC06-G01,	06	1/8"	13,5	4,2	5,5	24,8	11	4
MC06-G02,	06	1/4"	17	4,2	6,5	22,8	11	4
MC08-G01,	08	1/8"	12,8	5,2	5,5	26,5	13	5
MC08-G02,	08	1/4"	17	6,2	6,5	24	13	6
MC08-G03,	08	3/8"	20	6,2	7,5	24	13	6
MC10-G02,	10	1/4"	16	7,3	6,5	28,9	16	7
MC10-G03,	10	3/8"	21	8,3	7,5	29,4	16	8
MC10-G04,	10	1/2"	24	8,3	9	28,9	16	8
MC12-G02,	12	1/4"	16	7,3	6,5	31,9	19	7
MC12-G03,	12	3/8"	22	10,3	7,5	31,9	19	10
MC12-G04,	12	1/2"	24	10,3	9	31,2	19	10
MC14-G03,	14	3/8"	21	10,3	7,5	34,1	21	10
MC14-G04,	14	1/2"	25	12,3	9	33,6	21	12

**ML: Racor Inst. Metálico Codo Orientabl Cónico**



	T	F	A	H	L	L1	CH
ML04-M5	04	M5	9		17,3	20	8
ML04-01,	04	1/8"	11	8	17,7	18,6	13
ML04-02,	04	1/4"	9	11	19	23,5	14
ML06-M5	06	M5	11		20	20,6	8
ML06-01,	06	1/8"	11	8	19,8	18,6	13
ML06-02,	06	1/4"	11	11	22,1	23,5	14
ML08-01,	08	1/8"	13	8	23	20,5	13
ML08-02,	08	1/4"	13	11	23	23,5	14
ML08-03,	08	3/8"	13	11,5	24,5	26,5	17
ML10-02,	10	1/4"	16	11	26,4	25,5	14
ML10-03,	10	3/8"	16	11,5	26,4	26,5	17
ML12-02	12	1/4"	19	11,5	28,9	25,5	14
ML12-03,	12	3/8"	19	11,5	28,9	28,1	17
ML12-04,	12	1/2"	19	14	28,9	31,1	22
ML14-03,	14	3/8"	21	11,5	31,5	30,3	17
ML14-04,	14	1/2"	21	14	31,5	31,1	22

**ML-G: Racor Inst. Met. Codo Orient. Cilíndrico**



	T	F	A	L	L1	CH
ML04-G01	04	1/8"	11	17,7	18,6	13
ML04-G02	04	1/4"	9	19	22,5	16
ML06-G01	06	1/8"	11	20,6	18,5	13
ML06-G02	06	1/4"	11	22,1	22,5	16
ML08-G01	08	1/8"	13	23	20,5	13
ML08-G02	08	1/4"	13	23	22,5	16
ML08-G03	08	3/8"	13	24,5	25,5	18
ML10-G02	10	1/4"	16	26,4	24,5	16
ML10-G03	10	3/8"	16	26,4	25,5	18
ML10-G04	10	1/2"	11	27,9	29	21
ML12-G02	12	1/4"	19	28,9	24,5	16
ML12-G03	12	3/8"	19	28,9	24,5	18
ML12-G04	12	1/2"	19	28,9	31	21
ML14-G03	14	3/8"	21	31,5	28	18
ML14-G04	14	1/2"	21	31,5	33	21

**MT: Racor Inst. Metálico "T" Orientable Cónica**



	T	F	A	H	L	L1	CH
MT04-M5	04	M5	9		17,3	20	8
MT04-01,	04	1/8"	11	8	17,3	18,6	13
MT04-02,	04	1/4"	11	11	22,1	23,5	14
MT06-01,	06	1/8"	11	8	19,8	18,6	13
MT06-02,	06	1/4"	11	11	22,1	23,5	14
MT08-01,	08	1/8"	13	8	23	20,5	13
MT08-02,	08	1/4"	13	11	23	23,5	14
MT08-03,	08	3/8"	13	11,5	24,5	26,5	17
MT10-02,	10	1/4"	16	11	26,4	25,5	14
MT10-03,	10	3/8"	16	11,5	26,4	26,5	17
MT10-04,	10	1/2"					
MT12-03,	12	3/8"					
MT12-04,	12	1/2"					

**MT-G: Racor Inst. Metálico "T" Orientable Cil.**

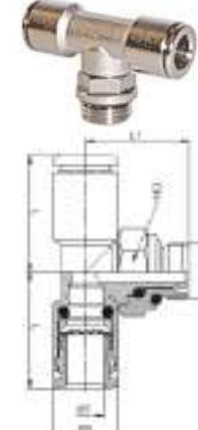

	T	F	A	L	L1	CH
MT04-G01	04	1/8"	11	17,3	18,5	13
MT04-G02	04	1/4"	11	22,1	23,5	14
MT06-G01	06	1/8"	11	20,6	18,5	13
MT06-G02	06	1/4"	11	22,1	22,5	16
MT08-G01	08	1/8"	13	23	20,5	13
MT08-G02	08	1/4"	13	23	22,5	16
MT08-G03	08	3/8"	13	24,5	25,5	18
MT10-G02	10	1/4"	16	26,4	24,5	16
MT10-G03	10	3/8"	16	26,4	25,5	18
MT12-G03	12	3/8"				
MT12-G04	12	1/2"				

**MCF: Racor Instantáneo Metálico Recto Cilíndr.**



	T	F	A	B	H	L	CH
MCF04-01	04	1/8"	12	3	6,5	26,5	9
MCF06-01	06	1/8"	12	5	6,5	28,3	11
MCF06-02	06	1/4"	17	5	10	31,3	11
MCF08-01	08	1/8"	12	7	6,5	28,5	13
MCF08-02	08	1/4"	17	7	10	32,5	13
MCF10-02	10	1/4"					
MCF10-03	10	3/8"					
MCF12-03	12	3/8"					
MCF12-04	12	1/2"					
MCF14-03	14	3/8"					

**MM: Racor Instantáneo Metálico Pasamuros**

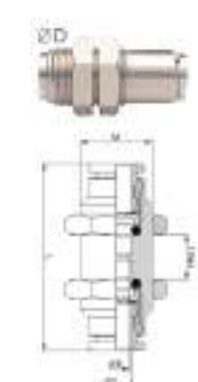

	T	M	B	L	Lmax
MM04	04	M11	3	32	8
MM06	06	M14	5	36,1	8
MM08	08	M16	7	38	10
MM10	10	M18	9	42,3	12
MM12	12	M22	11	45,8	17
MM14	14	M24	13	47,5	18



**MUC: Racor metal Inst. recto unión**

	T	A	B	L
MUC04	4	3	11	32
MUC06	6	5	13	36,1
MUC08	8	7	15	38
MUC10	10	9	18	42,3
MUC12	12	11	21	45,8
MUC14	14	13	23	48,9

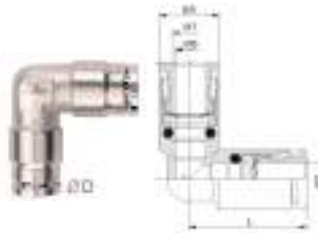

**MUL: Racor metal Inst. codo unión**

	T	A	B	L
MUL04	4	9	3	17,3
MUL06	6	11	5	20,6
MUL08	8	13	7	23
MUL10	10	16	8	26,4
MUL12	12	19	10	28,9
MUL14	14	21	12	31,5



**MUT: Racor metal Inst. "TE" unión**

	T	L	CH	CH1
MUT04	4	9	3	17,3
MUT06	6	11	5	20,6
MUT08	8	13	7	23
MUT10	10	16	8	26,4
MUT12	12	19	10	28,9
MUT14	14	21	12	31,5

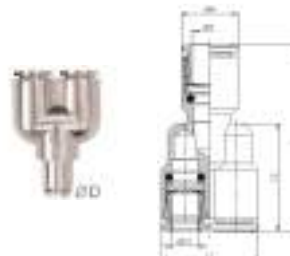

**MY: Racor metal Inst. "Y" unión**

	A	L	L1	L2
MY06	6	43	23	25,8
MY08	8	46,5	27	29
MY10	10	51,8	33	32,4



**MGJ: Racor Inst. Reduc. Espiga**

	B	T	A	L
MGJ04-06	6	4	9	32,5
MGJ04-08	8	4	9	34
MGJ06-08	8	6	11	36,3
MGJ06-10	10	6	13	39
MGJ06-12	12	6	13	40,3
MGJ08-10	10	8	16	41,4
MGJ08-12	12	8	13	39,5
MGJ10-12	12	10	16	41,4
MGJ10-14	14	10	16	43,9
MGJ12-14	14	12	19	45,9



**MMF: Pasamuros Hembra Cilíndrico**

	T	F	M	A	L
MMF04-01	4	1/8	M10	15,5	25,5 15
MMF06-01	6	1/8	M14	15,8	26,8 15
MMF06-02	6	1/4	M14	15,8	31,3 17
MMF08-01	8	1/8	M16	16	29 17
MMF08-02	8	1/4	M16	16	33,5 17



**MCJ: Racor Inst. Reduc. Espiga R.Cilíndrica**

	B	F	A	H	L	CH		B	F	A	H	L	CH	
MCJ04-M5	4	M5	8	4	24,2	8		MCJ08-03	8	3/8	20	7,5	37	13
MCJ04-01	4	1/8	13	5,5	27,7	13		MCJ10-02	10	1/4	16	5,5	38	13
MCJ04-02	4	1/4	16	6,5	30,7	13		MCJ10-03	10	3/8	20	7,5	41	13
MCJ06-M5	6	M5	8	4	27,5	8		MCJ12-02	12	1/4	16	6,5	39	13
MCJ06-01	6	1/8	13	5,5	31	13		MCJ12-03	12	3/8	20	7,5	42	13
MCJ06-02	6	1/4	16	6,5	33,5	13		MCJ12-04	12	1/2	24	9	44	16
MCJ08-01	8	1/8	13	5,5	32,5	13		MCJ14-03	14	3/8	20	7,5	44,5	16
MCJ08-02	8	1/4	16	6,5	35	13		MCJ14-04	14	1/2	24	9	46,5	16

**REGULADORES DE CAUDAL METÁLICOS: Unidireccionales (Bidireccionales bajo pedido) con tuerca manual o tornillo oculto.**

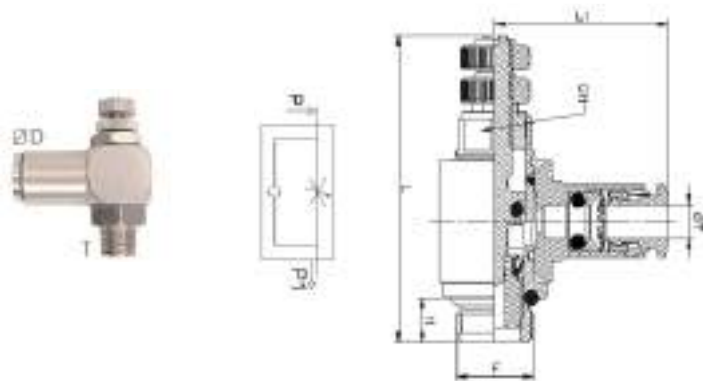

**MNSE: Regulador Caudal Codo banjo Inst. Met. R.Cilíndrica**

	T	F	H	L	L1	CH
MNSE04-M5	4	M5	4	33,7	19,5	8
MNSE04-01	4	1/8	5,5	43	21,1	9
MNSE06-M5	6	M5	4	33,7	22,3	8
MNSE06-01	6	1/8	5,5	43	24,3	9
MNSE06-02	6	1/4	6,5	50	25,5	12
MNSE08-01	8	1/8	5,5	43	24,8	9
MNSE08-02	8	1/4	6,5	50	26,5	12
MNSE08-03	8	3/8	7,5	66,3	28	20
MNSE10-02	10	1/4	6,5	50	28,4	12
MNSE10-03	10	3/8	7,5	66,3	29,9	20
MNSE12-03	12	3/8	7,5	66,3	31,4	20

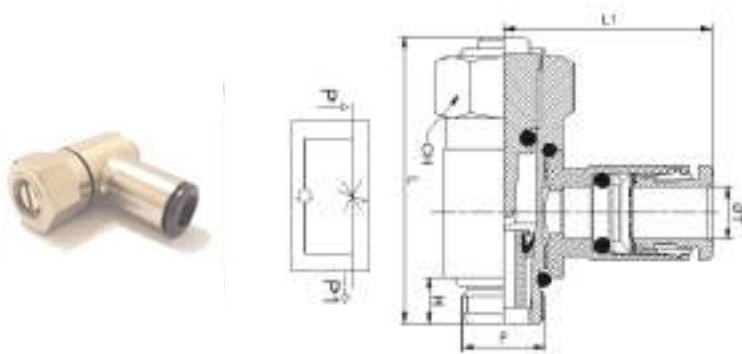

**MNSE(DC): Regulador Caudal Tornillo Oculto Codo banjo Inst. Metálico Rosca Cilíndrica**

	T	F	H	L	L1	CH
MNSE04-M5(DC)	4	M5	4	22,5	17	8
MNSE04-01(DC)	4	1/8	5,5	34	21,1	14
MNSE06-M5(DC)	6	M5	4	22,5	19,5	8
MNSE06-01(DC)	6	1/8	5,5	34	24,3	14
MNSE06-02(DC)	6	1/4	6,5	42	25,5	17
MNSE08-01(DC)	8	1/8	5,5	34	24,8	14
MNSE08-02(DC)	8	1/4	6,5	42	26,5	17
MNSE08-03(DC)	8	3/8	7,5	46,5	28	20
MNSE10-02(DC)	10	1/4	6,5	42	28,4	17
MNSE10-03(DC)	10	3/8	7,5	46,5	29,9	20
MNSE12-03(DC)	12	3/8	7,5	46,5	31,4	20

**RACORES RÁPIDOS DE TUERCA MOLETEADA SERIE "R":**

Fabricados totalmente en latón cromado CW614N/CW617N Roscas BSP Cónica UNI-ISO228 BSP cilíndrica UNI-ISO7 Diámetros tubo de 4 a 15mm exterior. Buena resistencia a temperatura. Presión nominal 15 bar,

**Montaje:** Una vez se ha asegurado que el tubo ha llegado al final del recorrido del racor, apretar la tuerca hasta estrangular el tubo, procurando no romper el tubo ni la rosca. Disponibilidad en **Acero Inoxidable Aisi 316 (referencias iguales con INOX- delante)**

**RPC: Racor Rápido Recto Macho rosca cónica**



	T	F	H	L	CH	CH1
RPC04-01	4/2	1/8	8	23,8	8	12
RPC06-01	6/4	1/8	8	26,5	12	12
RPC06-02	6/4	1/4	11	30	12	14
RPC06-03	6/4	3/8	10,5	31	12	17
RPC08-01	8/6	1/8	8	26,5	14	12
RPC08-02	8/6	1/4	11	30	14	14
RPC08-03	8/6	3/8	10,5	31	14	17
RPC10-01	10/8	1/8	8	28	16	14
RPC10-02	10/8	1/4	10,5	32	16	14
RPC10-03	10/8	3/8	11,5	32,5	16	17
RPC10-04	10/8	1/2	14	36	16	22
RPC12-03	12/10	3/8	11,5	35,5	18	17
RPC12-04	12/10	1/2	14	38,5	18	22
RPC15-04	15/12	1/2	14	40	22	22

**RPCF: Racor Rápido Recto Hembra rosca cilíndrica**



	T	F	H	L	CH	CH1
RPCF04-01	4/2	1/8	8	21,3	8	14
RPCF06-01	6/4	1/8	9	22,5	12	14
RPCF06-02	6/4	1/4	8	26	12	17
RPCF06-03	6/4	3/8	10	27,5	12	20
RPCF08-01	8/6	1/8	9	29,5	14	14
RPCF08-02	8/6	1/4	8	26	14	17
RPCF08-03	8/6	3/8	10	27,5	14	20
RPCF10-01	10/8	1/8	8	29,5	16	16
RPCF10-02	10/8	1/4	10	26,5	16	16
RPCF10-03	10/8	3/8	10	26	16	20
RPCF10-04	10/8	1/2	11,5	31	16	24
RPCF12-03	12/10	3/8	10	32,5	18	20

**RPL: Racor Rápido Codo Macho rosca cónica**



	T	F	H	L	L1	CH
RPL04-01	4/2	1/8	8,5	17	19,5	8
RPL06-01	6/4	1/8	8,5	17	20,5	12
RPL06-02	6/4	1/4	12,5	21	20,5	12
RPL06-03	6/4	3/8	11,5	28	29	12
RPL08-01	8/6	1/8	8	17	20,5	14
RPL08-02	8/6	1/4	12,5	21	20,5	14
RPL08-03	8/6	3/8	11,5	29	31	14
RPL10-01	10/8	1/8	8	24	32	16
RPL10-02	10/8	1/4	11	27	32	16
RPL10-03	10/8	3/8	11,5	29	32	16
RPL10-04	10/8	1/2	14	28	28	16
RPL12-03	12/10	3/8	14	26	29	18
RPL12-04	12/10	1/2	14	28	30,5	18
RPL15-04	15/12	1/2	14	28	34	22

**RPLF: Racor Rápido Codo Hembra rosca cónica**

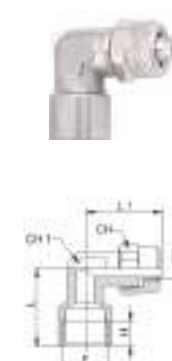

	T	F	H	L	L1	CH
RPLF06-01	6/4	1/8	9	24	26	12
RPLF06-02	6/4	1/4	8	23	23	12
RPLF08-01	8/6	1/8	7	20	20,5	14
RPLF08-02	8/6	1/4	11	29	31	14
RPLF10-02	10/8	1/4	11	29	32	16
RPLF12-03	12/10	3/8	10	30	29	19

**RPT Racor Rápido "TE" central cónica**



	T	F	H	L	L1	CH	CH1
RPT06-01,	6	1/8"	8	41	17	8	8
RPT06-02,	6	1/4"	13	41	21,5	12	8
RPT06-03,	6	3/8"	11,5	47	22,5	12	11
RPT08-01,	8	1/8"	8,5	41	17	14	10
RPT08-02,	8	1/4"	12,5	41	21	14	10
RPT08-03,	8	3/8"	15,3	41	23,8	14	10
RPT10-01,	10	1/8"	8	49	18,5	16	12
RPT10-02,	10	1/4"	11,8	49	22,3	16	12
RPT10-03,	6	1/8"	8	41	17	8	8
RPT10-04,	6	1/8"	8	41	17	8	8
RPT12-03,	6	1/8"	8	41	17	8	8
RPT12-04,	6	1/8"	8	41	17	8	8
RPT15-04,	6	1/8"	8	41	17	8	8

**RPST Racor Rápido "TE" lateral cónica**

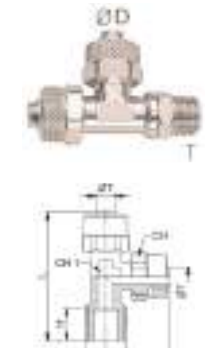

	T	F	H	L	L1	CH	CH1
RPST06-01	6	1/8"	8	41	17	8	8
RPST06-02	6	1/4"	13	41	21,5	12	8
RPST06-03	6	3/8"	11,5	47	22,5	12	11
RPST08-01	8	1/8"	8,5	41	17	14	10
RPST08-02	8	1/4"	12,5	41	21	14	10
RPST08-03	8	3/8"	15,3	41	23,8	14	10
RPST10-01	10	1/8"	8	49	18,5	16	12
RPST10-02	10	1/4"	11,8	49	22,3	16	12
RPST10-03	6	1/8"	8	41	17	8	8
RPST10-04	6	1/8"	8	41	17	8	8
RPST12-03	6	1/8"	8	41	17	8	8
RPST12-04	6	1/8"	8	41	17	8	8
RPST15-04	6	1/8"	8	41	17	8	8

**RPMM Racor Rápido pasamuos**



	T	F	L	CH	CH1
RPMM06	6	M10	45	12	14
RPMM08	8	M12	48	14	17
RPMM10	10	M14	54	16	17
RPMM12	12	M16	57	18	19
RPMM15	15	M20	59	22	24

**RPUC Racor Rápido recto unión**



	T	L	CH	CH1
RPUC06	6	34	12	12
RPUC08	8	35	14	14
RPUC10	10	38	16	14
RPUC12	12	41	18	17
RPUC15	15	45	22	22

**RPUL Racor Rápido codo unión**

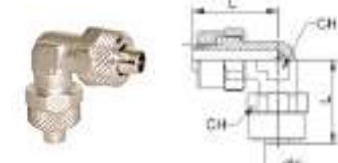

	T	L	CH	CH1
RPUL06	6	21	12	8
RPUL08	8	22	14	10
RPUL10	10	25	16	11
RPUL12	12	30	18	14
RPUL15	15	34	22	17

**RPUT Racor Rápido "TE" Unión**



	T	L	L1	CH	CH1
RPUT06	6	45	22	12	8
RPUT08	8	45	22	14	10
RPUT10	10	51	25	16	11
RPUT12	12	60	30	18	14
RPUT15	15	68	34	22	17

**RACORES TUERCA - BICONO SERIE "B":**

Fabricados en latón cromado BRASS CW614N/CW617N Bicono interior y refuerzo sin cromar. Roscas BSP Cónica UNI-ISO228 BSP cil. UNI-ISO7 Diámetros tubo de 4 a 18mm exterior. Tuerca y bicono norma DIN 3861-3870. Buena resistencia a temperatura. Presión máxima 110 bar hasta diámetro 8mm y 60 bar de 10 a 18mm. *Montaje:* Una vez se ha asegurado que el tubo ha llegado al final del recorrido del racor, apretar la tuerca hasta que el bicono interior estrangule el tubo, procurando no romper el tubo ni la rosca. Disponibles en **Acero Inox. Aisi 316 DIN 2353 o Doble anillo** Aceo inox DIN2353 tienen los mismos códigos que el latón pero añadiendo INOX- delante. El de doble anillo tipo LOCK se vende bajo pedido.

**BPC: Bicono cónico Recto - INOXBPC (a.inox.)**

	T	F	H	L	CH	CH1
BPC04-01	4	1/8"	8	27	10	11
BPC06-01	6	1/8"	8	28	12	11
BPC06-02	6	1/4"	11	31,5	12	14
BPC08-01	8	1/8"	8	29,5	14	12
BPC08-02	8	1/4"	11	33	14	14
BPC08-03	8	3/8"	11,5	34	14	17
BPC10-02	10	1/4"	11	33	19	16
BPC10-03	10	3/8"	11,5	38	19	17
BPC10-04	10	1/2"	14	40,5	22	19
BPC12-03	12	3/8"	11,5	33,5	22	18
BPC12-04	12	1/2"	14	36,5	22	22
BPC14-04	14	1/2"	14	40	27	22
BPC15-04	15	1/2"	14	41	27	22
BPC16-04	16	1/2"	14	42	30	24
BPC18-04	18	1/2"	14	43	32	26

**BPL: Bicono codo conico - INOXBPL**

	T	F	H	L	L1	CH	CH1
BPL04-01	4	1/8"	8	21	16,5	10	10
BPL06-01	6	1/8"	8	23	16,5	12	10
BPL06-02	6	1/4"	12,5	24,5	22,5	12	11
BPL08-01	8	1/8"	8	24	16,5	14	10
BPL08-02	8	1/4"	12,5	24	22,5	14	11
BPL08-03	8	3/8"	11	32,5	24,1	14	14
BPL10-02	10	1/4"	12,5	32	24	19	13
BPL10-03	10	3/8"	13,6	32	26,5	19	17
BPL10-04	10	1/2"	14	33	28,8	19	16
BPL12-03	12	3/8"	11,5	33,5	22	22	18
BPL12-04	12	1/2"	14	36,5	22	22	22
BPL14-04	14	1/2"	14	40	27	27	22
BPL15-04	15	1/2"	14	41	27	27	22
BPL16-04	16	1/2"	14	42	30	30	24
BPL18-04	18	1/2"	14	43	32	32	26

**BPT: Bicono "TE" rosca central cónico**

	T	F	H	L	CH	CH1
BPT04-01	4	1/8"	8	27	10	11
BPT06-01	6	1/8"	8	28	12	11
BPT06-02	6	1/4"	11	31,5	12	14
BPT08-01	8	1/8"	8	29,5	14	12
BPT08-02	8	1/4"	11	33	14	14
BPT08-03	8	3/8"	11,5	34	14	17
BPT10-02	10	1/4"	11	33	19	16
BPT10-03	10	3/8"	11,5	38	19	17
BPT10-04	10	1/2"	14	40,5	22	19
BPT12-03	12	3/8"	11,5	33,5	22	18
BPT12-04	12	1/2"	14	36,5	22	22
BPT14-04	14	1/2"	14	40	27	22
BPT15-04	15	1/2"	14	41	27	22
BPT16-04	16	1/2"	14	42	30	24
BPT18-04	18	1/2"	14	43	32	26

**BPST: Bicono "TE" rosca lateral cónico**

	T	F	H	L	CH	CH1
BPST04-01	4	1/8"	8	27	10	11
BPST06-01	6	1/8"	8	28	12	11
BPST06-02	6	1/4"	11	31,5	12	14
BPST08-01	8	1/8"	8	29,5	14	12
BPST08-02	8	1/4"	11	33	14	14
BPST08-03	8	3/8"	11,5	34	14	17
BPST10-02	10	1/4"	11	33	19	16
BPST10-03	10	3/8"	11,5	38	19	17
BPST10-04	10	1/2"	14	40,5	22	19
BPST12-03	12	3/8"	11,5	33,5	22	18
BPST12-04	12	1/2"	14	36,5	22	22
BPST14-04	14	1/2"	14	40	27	22
BPST15-04	15	1/2"	14	41	27	22
BPST16-04	16	1/2"	14	42	30	24
BPST18-04	18	1/2"	14	43	32	26

**BPMM: Racor Bicono Pasamuros unión**

	T	L	CH	CH1
BPMM06	06	51,5	12	14
BPMM08	08	55,5	14	16
BPMM10	10	62,5	19	19
BPMM12	12	64,5	22	22
BPMM14	14	69,5	25	27
BPMM15	15	69,5	25	27

**BPUC: Bicono Recto Unión - INOXBUC**

	T	L	CH	CH1
BPUC04	04	33,5	10	10
BPUC06	06	36,5	12	12
BPUC08	08	38,5	14	14
BPUC10	10	47,5	19	17
BPUC12	12	50,5	22	19
BPUC14	14	55,5	27	24
BPUC15	15	55,5	27	24
BPUC16	16	58	24	30
BPUC18	18	60	26	32

**BPUL: Bicono Codo Unión - INOXPUL**

	T	L	CH	CH1
BPUL04	04	21	10	9
BPUL06	06	23	12	9
BPUL08	08	24	14	11
BPUL10	10	32	19	13
BPUL12	12	34,5	22	15
BPUL14	14	38	27	17
BPUL15	15	38	27	17
BPUL16	16	39,5	30	19
BPUL18	18	44	32	22

**BPUL: Bicono "TE" Unión - INOXPBPUT**

	T	L	L1	CH	CH1
BPUL04	04	42	21	10	9
BPUL06	06	46	16,5	12	10
BPUL08	08	48	24	14	11
BPUL10	10	64	32	19	13
BPUL12	12	69	34,5	22	15
BPUL14	14	76	38	27	17
BPUL15	15	76	38	27	17
BPUL16	16	79	39,5	30	19
BPUL18	18	88	44	32	22

**BPB: Bicono recambio diámetro ext. - INOXPBPB**

BPB04	Bicono recambio	T04 mm
BPB06	Bicono recambio	T06 mm
BPB08	Bicono recambio	T08 mm
BPB10	Bicono recambio	T10 mm
BPB12	Bicono recambio	T12 mm
BPB14	Bicono recambio	T14 mm
BPB15	Bicono recambio	T15 mm
BPB16	Bicono recambio	T16 mm
BPB18	Bicono recambio	T18 mm

**BPRE: Refuerzo para Interior tubería - INOXPBRE**

BPRE04	Refuerzo recambio	T04 Diametro Int. 2mm
BPRE06	Refuerzo recambio	T06 D.Interior 4mm
BPRE08	Refuerzo recambio	T08 D.Interior 6mm
BPRE10	Refuerzo recambio	T10 D.Interior 8mm
BPRE12	Refuerzo recambio	T12 D.Interior 10mm
BPRE14	Refuerzo recambio	T14 D.Interior 12mm
BPRE16	Refuerzo recambio	T16 D.Interior 14mm
BPRE18	Refuerzo recambio	T18 D.Interior 16mm

Pueden ser de otros materiales como A.INOX, TEFLÓN, PVDF, PP, etc (Soliciten oferta):  
 Totalmente fabricados en latón cromado BRASS (o Acero Inoxidable AISI 316, Código igual empujado en INOX- p.ej. INOXPSM0101) . Rosca cónica y cilíndrica. Óptimos para complementación en usos industriales en aire comprimido y otro tipo de fluidos. Resistentes al agua, grasa y aceites.

**PSM: RACOR ROSCADO "MACHÓN" CÓNICO MxM**



	F	F1	A	B	L	CH
PSM01-01	1/8"	1/8"	8	8	20	12
PSM02-02	1/4"	1/4"	11	11	27	14
PSM03-03	3/8"	3/8"	11,5	11,5	28	17
PSM04-04	1/2"	1/2"	14	14	33,5	22
PSM05-05	3/4"	3/4"	16,5	16,5	40	27
PSM06-06	1"	1"	19	19	45,5	34
PSM01-M5	M5	1/8"	6,5	5	15,5	14
PSM01-02	1/8"	1/4"	11	8	24	14
PSM01-03	1/8"	3/8"	11,5	8	24,5	17
PSM01-04	1/8"	1/2"	14	8	27	24
PSM02-03	1/4"	3/8"	9	8	22	19
PSM02-04	1/4"	1/2"	10	8	23,5	24
PSM03-04	3/8"	1/2"	10	9	24,5	24
PSM04-05	1/2"	3/4"	11	11	27,5	30
PSM05-06	1"	3/4"	13	11	30	36

**PSM-G: RACOR ROSCADO "MACHÓN" CILÍNDRICO MxM**



	F	F1	A	B	L	CH
PSMM5-M5	M5	M5	4	4	11,5	8
PSM01-G01	1/8"	1/8"	6	6	16,5	14
PSM02-G02	1/4"	1/4"	8	8	21	17
PSM03-G03	3/8"	3/8"	9	9	23	19
PSM04-G04	1/2"	1/2"	10	10	25,5	24
PSM05-G05	3/4"	3/4"	11	11	27,5	30
PSM06-G06	1"	1"	13	13	32	36
PSMM5-G01	M5	1/8"	6,5	5	15,5	14
PSM01-G02	1/8"	1/4"	8	6	19	17
PSM01-G03	1/8"	3/8"	9	6	20	19
PSM01-G04	1/8"	1/2"	10	6	21	19
PSM02-G03	1/4"	3/8"	9	8	22	19
PSM02-G04	1/4"	1/2"	10	8	23,5	24
PSM03-G04	3/8"	1/2"	10	9	24,5	24
PSM04-G05	1/2"	3/4"	11	10	27,5	30
PSM05-G06	3/4"	1"	13	11	29,5	35

**PSF-G: RACOR MANGUITO CILÍNDRICO HxH**

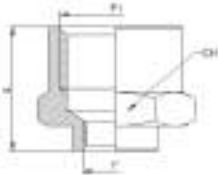

	F	F1	L	CH
PSFM5-M5	M5	M5	11	8
PSF01-G01	1/8"	1/8"	15	14
PSF02-G02	1/4"	1/4"	22	17
PSF03-G03	3/8"	3/8"	24	22
PSF04-G04	1/2"	1/2"	30	26
PSF05-G05	3/4"	3/4"	32	32
PSF06-G06	1"	1"	32	38
PSF01-GM5	M5	1/8"	12,5	14
PSF01-G02	1/8"	1/4"	19,5	17
PSF01-G03	1/8"	3/8"	20	22
PSF01-G04	1/8"	1/2"	24	24
PSF02-G03	1/4"	3/8"	23	22
PSF02-G04	1/4"	1/2"	24	27
PSF03-G04	3/8"	1/2"	27,5	26
PSF03-G05	3/8"	3/4"	25	32
PSF04-G05	1/2"	3/4"	30	32
PSF04-G06	1/2"	1"	25	38
PSF05-G06	3/4"	1"	25	38

**PSQ: PROLONGADOR CONICO MxH**



	F	F1	H	L	CH
PSQ01-01	1/8"M	1/8"H	6	16,5	14
PSQ01-02	1/8"M	1/4"H	6	20,5	17
PSQ01-03	1/8"M	3/8"H	6	23	22
PSQ02-02	1/4"M	1/4"H	8	22	17
PSQ02-03	1/4"M	3/8"H	8	24	22
PSQ02-04	1/4"M	1/2"H	8	28,5	26
PSQ03-03	3/8"M	3/8"H	9	25	22
PSQ03-04	3/8"M	1/2"H	9	29,5	26
PSQ04-04	1/2"M	1/2"H	10	30	26
PSQ04-05	1/2"M	3/4"H	10	31	32
PSQ05-06	3/4"M	1"H	8	25	38

**PSR: RACOR REDUCCIÓN CÓNICA HxM**

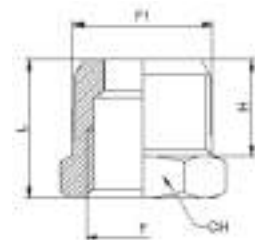

	F	F1	H	L	CH
PSR01-02	1/8"H	1/4"M	11	16	14
PSR01-03	1/8"H	3/8"M	11,5	16,5	17
PSR02-03	1/4"H	3/8"M	11,5	16,5	17
PSR01-04	1/8"H	1/2"M	14	19,5	22
PSR02-04	1/4"H	1/2"M	14	19,5	22
PSR02-05	1/4"H	3/4"M	14	20	27
PSR03-04	3/8"H	1/2"M	14	19,5	22
PSR03-05	3/8"H	3/4"M	14	20	27
PSR04-05	1/2"H	3/4"M	16,5	23,5	27
PSR05-06	3/4"H	1"M	15,5	21,5	34

**PSR-G: RACOR REDUCCIÓN CILÍNDRICA HxM**

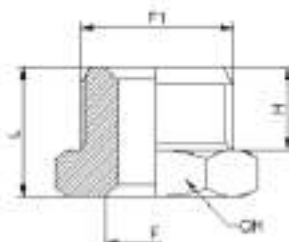

	F	F1	H	L	CH
PSRM5-G01	M5	1/8"M	6	10,5	14
PSR01-G02	1/8"H	1/4"M	8	13	17
PSR01-G03	1/8"H	3/8"M	9	14	19
PSR01-G04	1/8"H	1/2"M	10	15	24
PSR02-G03	1/4"H	3/8"M	9	14	19
PSR02-G04	1/4"H	1/2"M	10	15,5	24
PSR03-G04	3/8"H	1/2"M	10	15,5	24
PSR03-G05	3/8"H	3/4"M	11	17,5	30
PSR04-G05	1/2"H	3/4"M	12	18	30
PSR05-G06	3/4"H	1"M	11,5	18,5	36

Totalmente fabricados en latón niquelado Rosca Macho cónica y/o cilíndrica, La rosca Hembra siempre es cilíndrica.



**PSQL: RACOR PROLONGADOR LARGO CILÍNDRICO MxH**

	F	F1	H	L	CH
PSQL01-01	1/8"M - 1/8"H	6	22	14	
PSQL02-02	1/4"M - 1/4"H	8	35	17	
PSQLL01-01	1/8"M - 1/8"H	6	32	14	
PSQLL02-02	1/4"M - 1/4"H	8	51	17	
PSQL03-03	3/8"M - 3/8"H	9	41	22	
PSQL04-04	1/2"M - 1/2"H	10	36	24	
PSQL05-05	3/4"M - 3/4"H	12	50	30	
PSQL06-06	1"M - 1"H	12	50	38	



**PFL-G: RACOR CODO CILÍNDRICO HxH**

	F	H	L	CH
PFLM5-M5	M5	4	11	9
PFL01-G01	1/8"	7	20	10
PFL02-G02	1/4"	8	25,5	13
PFL03-G03	3/8"	10	29	17
PFL04-G04	1/2"	11	35	20
PFL05-G05	3/4"	16,5	36,5	25
PFL06-G06	1"	19	45	30



**PEFL: RACOR CODO CÓNICO MxH**

	F	H	H1	L	L1	CH
PEFLM5-M5	M5	4	4	11,5	13,5	8
PEFL01-01	1/8"	8	7	19	20	10
PEFL02-02	1/4"	12,5	8	14	25,5	13
PEFL03-03	3/8"	13,6	10	26,5	29	17
PEFL04-04	1/2"	15,5	11	31,5	35	21
PEFL05-05	3/4"	16	16,5	33	36,5	25
PEFL06-06	1"	17	19	39	45	30



**PEL: RACOR CODO CÓNICO MxM**

	F	H	H1	L	L1	CH
PELM5-M5	M5	4	4	12	12	9
PEL01-01	1/8"	8	8	19	19	10
PEL02-02	1/4"	12,5	12,5	24	24	13
PEL03-03	3/8"	13,6	13,6	26,5	26,5	17
PEL04-04	1/2"	15,5	15,5	31,5	31,5	20
PEL05-05	3/4"	16	16	33	33	25
PEL06-06	1"	17	17	39	39	30



**PFT-G: RACOR "TE" UNIÓN HEMBRA HxHxH CILÍNDRICA**

	F	H	L	L1	CH
PFTM5-M5	M5	5	22	11	9
PFT01-G01	1/8"	7	40	20	10
PFT02-G02	1/4"	8	51	25,5	13
PFT03-G03	3/8"	10	58	29	17
PFT04-G04	1/2"	11	70	35	20
PFT05-G05	3/4"	16,5	73	36,5	25
PFT06-G06	1"	19	90	45	30



**PMT: RACOR "TE" CENTRAL MACHO HxMxH CÓNICO**

	F	H	L	L1	CH
PMTM5-M5	M5	7	40	19	10
PMT01-G01	1/8"	7	40	19	10
PMT02-G02	1/4"	8	51	24	13
PMT03-G03	3/8"	10	58	26,5	17
PMT04-G04	1/2"	11	70	31,5	20
PMT05-G05	3/4"	16,5	73	33	25
PMT06-G06	1"	11	70	31,5	20



**PEMT: RACOR "TE" UNIÓN MACHO MxMxM CÓNICO**

	F	H	L	L1	CH
PEMTM5-M5	M5	8	38	19	10
PEMT01-01	1/8"	8	38	19	10
PEMT02-02	1/4"	12,5	48	24	13
PEMT03-03	3/8"	13,6	53	26,5	17
PEMT04-04	1/2"	15,5	63	31,5	20
PEMT05-05	3/4"	16,2	66,4	33	25
PEMT06-06	1"	8	38	19	10



**PEFT: RACOR "TE" LATERAL MACHO HxHxM CÓNICO**

	F	H	L	L1	CH
PEFTM5-M5	M5	7	39	19	10
PEFT01-01	1/8"	7	39	19	10
PEFT02-02	1/4"	8	49,5	24	13
PEFT03-03	3/8"	10	55,5	26,5	17
PEFT04-04	1/2"	11	66,5	31,5	20
PEFT05-05	3/4"	16,5	69,5	33	25
PEFT06-06	1"	7	39	19	10



**PEMMT: RACOR "TE" LATERAL HEMBRA MxMxH CÓNICO**

	F	H	L	L1	CH
PEMMTM5-M5	M5	8	39	20	10
PEMMT01-01	1/8"	8	39	20	10
PEMMT02-02	1/4"	12,5	49,5	25,5	13
PEMMT03-03	3/8"	13,6	55,5	29	17
PEMMT04-04	1/2"	15,5	66,5	35	20
PEMMT05-05	3/4"	16	69,5	36,5	25
PEMMT06-06	1"	8	39	20	10



**PEMNT: RACOR "TE" CENTRAL HEMBRA MxHxM CÓNICO**

	F	H	L	L1	CH
PEMNTM5-M5	M5	7	38	20	10
PEMNT01-01	1/8"	7	38	20	10
PEMNT02-02	1/4"	8	48	25,5	13
PEMNT03-03	3/8"	10	53	29	17
PEMNT04-04	1/2"	11	63	35	20
PEMNT05-05	3/4"	7	38	20	10
PEMNT06-06	1"	7	38	20	10

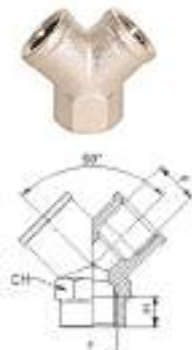

**PFY: RACOR "Y" HEMBRACILÍNDRICA HxHxH**

	F	H	CH
PFY01-01	1/8"	8	13
PFY02-02	1/4"	11	17
PFY03-03	3/8"	11,5	20
PFY04-04	1/2"	14	25



**PMY: RACOR "Y" MACHO CENTRAL CÓNICO HxMxH**

	F	H	CH
PMY01-01	1/8"	8	13
PMY02-02	1/4"	11	17
PMY03-03	3/8"	11,5	20
PMY04-04	1/2"	14	25



**PFC: RACOR "X" CRUZ HEMBRACILÍNDRICA HxHxHxH**

	F	H	H1	L	L1	CH
PFC01-01	1/8"	8	8	46	23	13
PFC02-02	1/4"	12,5	12,5	51	24	13
PFC03-03	3/8"	13,5	13,6	58	26,5	17
PFC04-04	1/2"	14	14	67	31	31



**PEFC: RACOR "X" CRUZ MACHO CENTRAL CÓNICA MxHxHxH**

	F	H	H1	L	L1	CH
PEFC01-01	1/8"	7	8	46	23	13
PEFC02-02	1/4"	8	12,5	51	24	13
PEFC03-03	3/8"	10	13,6	58	26,5	17
PEFC04-04	1/2"	14	14	67	31	31

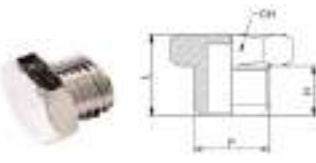

**PO: TAPÓN CONICO M.**

	F	H	L	CH
PO-01	1/8"	7,5	11,5	10
PO-02	1/4"	11	15,5	14
PO-03	3/8"	11	16	17
PO-04	1/2"	12	17,5	22
PO-05	3/4"	13	19,5	27
PO-06	1"	16	22	34

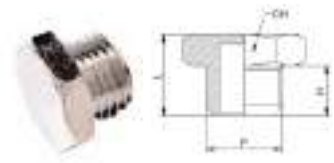

**PO-G: TAPÓN CILÍNDRICO M.**

	F	H	L	CH
PO-M5	M5	4	7	8
PO-G01	1/8"	6	10,5	14
PO-G02	1/4"	8	13	17
PO-G03	3/8"	9	14	19
PO-G04	1/2"	10	15,5	24
PO-G05	3/4"	11	16,5	30
PO-G06	1"	13	19	38

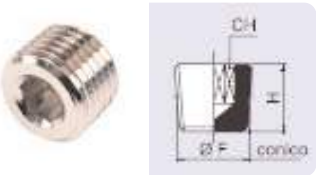

**POA: TAPÓN ALLEN CONICO. M.**

	F	H	CH
POA01	1/8"	8	5
POA02	1/4"	10	6
POA03	3/8"	10,5	8
POA04	1/2"	13	10
POA05	3/4"	15,5	14
POA06	1"	17,5	17



**POAT: TAPÓN ALLEN CIL. JUNTA**

	F	H	L	A	CH
POAT01	1/8"	6	8	14	4
POAT02	1/4"	8	10	17	6
POAT03	3/8"	9	12	20	8
POAT04	1/2"	11	14	24	10

**POMM-G: PASAMUROS CILÍNDRICO**



	F	F1	L	L1	CH	CH1
POMM01-G01	1/8"	M16	18	14	19	22
POMM02-G02	1/4"	M20	25	21	24	27
POMM03-G03	3/8"	M26	26	21	30	32
POMM04-G04	1/2"	M28	33	27	32	36



**POF: TAPÓN CILÍNDRICO H.**

	F	H	L	CH
POF01	1/8"	9	11	14
POF02	1/4"	8	16	17
POF03	3/8"	11	13,5	21
POF04	1/2"	11	13,5	24
POF05	3/4"			
POF06	1"			

**PEM: ESPIGA P/MANGUERA MACHO CON.**



	D	F	H	L	CH
PEM07-01	7	1/8"	6	31,5	12
PEM07-02	7	1/4"	11	32	14
PEM09-01	9	1/8"	8	31,5	12
PEM09-02	9	1/4"	11	35	14
PEM09-03	9	3/8"	11,5	35,5	17
PEM10-01	10	1/8"	8	32,5	12
PEM10-02	10	1/4"	11	36	14
PEM10-03	10	3/8"	11,5	36,5	17
PEM10-04	10	1/2"	14	39,5	22
PEM12-02	12	1/4"	11	36	14
PEM12-03	12	3/8"	11,5	36,5	17
PEM12-04	12	1/2"	14	39,5	22
PEM14-03	14	3/8"	11,5	38,5	17
PEM14-04	14	1/2"	14	41,5	22
PEM17-03	17	3/8"	11,5	40,5	18
PEM17-04	17	1/2"	14	43,5	22
PEM20-03	20	3/8"	11,5	41,5	18
PEM20-04	20	1/2"	14	43,5	22
PEM20-05	20	3/4"	16,5	46,5	27
PEM25-05	25	3/4"	16,5	53	27
PEM25-06	25	1"	19	56	34



**PEH: RACOR ESPIGA P/MANGUERA H.**

	D	F1	H	L	L1	CH
PEH07-01	7	1/8"	7	32	19	12
PEH07-02	7	1/4"	8	33	20	17
PEH09-01	9	1/8"	8	29	19	12
PEH09-02	9	1/4"	11	33	20	15
PEH10-02	10	1/4"	11	33	20	15
PEH10-03	10	3/8"	11,5	33	20	19
PEH12-03	12	3/8"	11,5	33	20	19
PEH12-04	12	1/2"	14	36	20	24
PEH16-03	16	3/8"	11,5	35	22	19
PEH16-04	16	1/2"	14	38	22	24
PEH20-05	20	3/4"	15	41	24	29
PEH25-05	25	3/4"	11,5	33	20	19

**PEU: ESPIGA P/MANGUERA UNIÓN**

	D1	D2	L1	L
PEU0606	6	6	20	42
PEU0808	8	8	20	42
PEU1010	10	10	20	42

**RACORES Y COMPLEMENTOS ROSCADOS EN ACERO INOXIDABLE :**

Totalmente fabricados en Acero Inoxidable AISI 316, Código igual que los de latón pero empezado en INOX- (p.ej. INOXPSM0101) . Rosca cónica Macho y cilíndrica Hembra. Óptimos para complementación en usos industriales en aire comprimido y otro tipo de fluidos. Resistentes al agua, grasa, aceites y químicos (Ver tabla de compatibilidades). SUS316

**INOXPSM : "MACHÓN" INOX. CÓNICO MxM FIG. 245 y 280**



		S	L
INOXPSM0101	Machón Inox.316 Fig. 280 1/8-1/8	20	15
INOXPSM0201	Machón Inox.316 Fig. 245 1/4-1/8	22,5	15
INOXPSM0202	Machón Inox.316 Fig. 280 1/4-1/4	25	15
INOXPSM0302	Machón Inox.316 Fig. 245 3/8-1/4	26,5	18
INOXPSM0303	Machón Inox.316 Fig. 280 3/8-3/8	27	18
INOXPSM0402	Machón Inox.316 Fig. 245 1/2-1/4	30	23
INOXPSM0403	Machón Inox.316 Fig. 245 1/2-3/8	30,5	23
INOXPSM0404	Machón Inox.316 Fig. 280 1/2-1/2	34	23
INOXPSM0504	Machón Inox.316 Fig. 245 3/4-1/2	35,5	28
INOXPSM0505	Machón Inox.316 Fig. 280 3/4-3/4	36,5	28
INOXPSM0604	Machón Inox.316 Fig. 245 1-1/2	38,5	35
INOXPSM0605	Machón Inox.316 Fig. 245 1-3/4	39,5	35
INOXPSM0606	Machón Inox.316 Fig. 280 1-1	42	35
INOXPSM0706	Machón Inox.316 Fig. 245 1.1/4-1	45	44
INOXPSM0707	Machón Inox.316 Fig. 280 1.1/4-1.1/4	47,5	44
INOXPSM0806	Machón Inox.316 Fig. 245 1.1/2-1	45	50
INOXPSM0807	Machón Inox.316 Fig. 245 1.1/2-1.1/4	47,5	50
INOXPSM0808	Machón Inox.316 Fig. 280 1.1/2-1.1/2	47,5	50
INOXPSM0907	Machón Inox.316 Fig. 245 2" - 1.1/4"	52,5	62
INOXPSM0908	Machón Inox.316 Fig. 245 2-1.1/2	52,5	62
INOXPSM0909	Machón Inox.316 Fig. 280 2-2	57	62
INOXPSM1010	Machón Inox.316 Fig. 280 2.1/2-2.1/2	61	77
INOXPSM1111	Machón Inox.316 Fig. 280 3-3	67,5	90



**INOXPSF: "MANGUITO" INOX. HxH CILÍNDRICO UNIÓN FIG.270**

		L
INOXPSF01	Manguito fig. 270 HxH 1/8	24
INOXPSF02	Manguito fig. 270 HxH 1/4	24
INOXPSF03	Manguito fig. 270 HxH 3/8	25
INOXPSF04	Manguito fig. 270 HxH 1/2	32
INOXPSF05	Manguito fig. 270 HxH 3/4	35
INOXPSF06	Manguito fig. 270 HxH 1	41
INOXPSF07	Manguito fig. 270 HxH 1.1/4	45
INOXPSF08	Manguito fig. 270 HxH 1.1/2	45
INOXPSF09	Manguito fig. 270 HxH 2	53
INOXPSF10	Manguito fig. 270 HxH 2.1/2	63
INOXPSF11	Manguito fig. 270 HxH 3	69

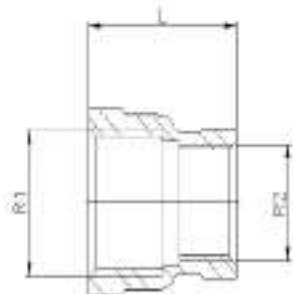

**INOXPSF: "MANGUITO" INOX. HxH REDUCCIÓN CIL. FIG.240**

		L
INOXPSF0102	Manguito reducción fig. 240 1/8H x 1/4H	25
INOXPSF0203	Manguito reducción fig. 240 1/4Hx3/8H	26
INOXPSF0204	Manguito reducción fig. 240 1/4Hx1/2H	34
INOXPSF0304	Manguito reducción fig. 240 3/8Hx1/2H	34
INOXPSF0405	Manguito reducción fig. 240 H1/2 x 3/4H	36
INOXPSF0506	Manguito reducción fig. 240 H3/4 x 1"H	42
INOXPSF0607	Manguito reducción fig. 240 H1" x 1.1/4"H	48
INOXPSF0708	Manguito reducción fig. 240 H1.1/4 x 1.1/2"H	52
INOXPSF0809	Manguito reducción fig. 240 1.1/2Hx 2"H	58



**INOXPSR: RACOR INOX. MxH REDUCCIÓN CON. FIG.241**

		L	S
INOXPSR0201	Reducción Inox. F241 1/4M - H1/8	14,5	15
INOXPSR0302	Reducción Inox. F241 3/8M - H1/4	16	18
INOXPSR0402	Reducción Inox. F241 1/2M - H1/4	19,5	23
INOXPSR0403	Reducción Inox. F241 1/2M - H3/8	19,5	23
INOXPSR0503	Reducción Inox. F241 3/4M - H3/8	21	28
INOXPSR0504	Reducción Inox. F241 3/4M - H1/2	21	28
INOXPSR0604	Reducción Inox. F241 1M - H1/2	24	35
INOXPSR0605	Reducción Inox. F241 1M - H3/4	24	35
INOXPSR0705	Reducción Inox. F241 1.1/4M - H3/4	27	44
INOXPSR0706	Reducción Inox. F241 1.1/4M - H1	27	44
INOXPSR0806	Reducción Inox. F241 1.1/2M - H1	27	50
INOXPSR0807	Reducción Inox. F241 1.1/2M - H1.1/4	27	50
INOXPSR0906	Reducción Inox. F241 2M - H1	32	62
INOXPSR0907	Reducción Inox. F241 2M - H1.1/4	32	62
INOXPSR0908	Reducción Inox. F241 2M - H1.1/2	32	62
INOXPSR1009	Reducción Inox. F241 2.1/2M - H2	34	77
INOXPSR1110	Reducción Inox. F241 3M - H2.1/2	37,5	90

**RACORES Y COMPLEMENTOS ROSCADOS EN ACERO INOXIDABLE :**

Totalmente fabricados en Acero Inoxidable AISI 316, Rosca BSP cónica Macho y cilíndrica Hembra. Óptimos para complementación en usos industriales en aire comprimido y otro tipo de fluidos. Resistentes al agua, grasa, aceites y químicos (Ver tabla de compatibilidades).

**INOXPSQ : "PROLONGADOR" INOX. CÓNICO MxH**



<b>INOX-PSQ01-02</b>	Racor Inox alargó cónica 1/8"M - 1/4"H
<b>INOX-PSQ02-03</b>	Racor Inox alargó cónica 1/4"M - 3/8"H
<b>INOX-PSQ03-04</b>	Racor Inox alargó cónica 3/8"M - 1/2"H
<b>INOX-PSQ04-05</b>	Racor Inox alargó cónica 1/2"M - 3/4"H



**INOXF149: "ENTRONQUE" INOX. SOLDAR M CILÍNDRICO UNIÓN FIG.149**

		<b>B</b>	<b>E</b>	<b>L</b>
<b>INOXF14902</b>	Entronque Inox soldar F149 1/4	13,7	2,24	30
<b>INOXF14903</b>	Entronque Inox soldar F149 3/8	17,1	2,31	30
<b>INOXF14904</b>	Entronque Inox soldar F149 1/2	21,3	2,77	35
<b>INOXF14905</b>	Entronque Inox soldar F149 3/4	26,7	2,87	40
<b>INOXF14906</b>	Entronque Inox soldar F149 1"	33,4	3,38	40
<b>INOXF14907</b>	Entronque Inox soldar F149 1.1/4	42,2	3,56	50
<b>INOXF14908</b>	Entronque Inox soldar F149 1.1/2	48,3	3,68	50
<b>INOXF14909</b>	Entronque Inox soldar F149 2"	60,3	3,91	50
<b>INOXF14910</b>	Entronque Inox soldar F149 2.1/2"	76,1	5,16	60
<b>INOXF14911</b>	Entronque Inox soldar F149 3"	88,9	5,49	70



**INOXF340: "ENLACE" INOX 3 PIEZAS HxH FIG.340**

		<b>L</b>	<b>S1</b>	<b>S2</b>
<b>INOXF34002</b>	Enlace Inox 3 piezas HxH F340 1/4	33,5	17	29
<b>INOXF34003</b>	Enlace Inox 3 piezas HxH F340 3/8	36,5	20	34
<b>INOXF34004</b>	Enlace Inox 3 piezas HxH F340 1/2	39,5	25	39
<b>INOXF34005</b>	Enlace Inox 3 piezas HxH F340 3/4	42,5	30	47
<b>INOXF34006</b>	Enlace Inox 3 piezas HxH F340 1"	50	38	58
<b>INOXF34007</b>	Enlace Inox 3 piezas HxH F340 1.1/4	54	47	67
<b>INOXF34008</b>	Enlace Inox 3 piezas HxH F340 1.1/2	58	53	76
<b>INOXF34009</b>	Enlace Inox 3 piezas HxH F340 2"	65	66	90
<b>INOXF34010</b>	Enlace Inox 3 piezas HxH F340 2.1/2"	75	82	109
<b>INOXF34011</b>	Enlace Inox 3 piezas HxH F340 3"	83	96	123



**INOXPFL: RACOR INOX. CODO HxH CIL. FIG.90**

		<b>A</b>
<b>INOXPFL01</b>	Racor codo Fig.90 inox 1/8	16
<b>INOXPFL02</b>	Racor codo Fig.90 inox 1/4	19
<b>INOXPFL03</b>	Racor codo Fig.90 inox 3/8	23
<b>INOXPFL04</b>	Racor codo Fig.90 inox 1/2	27
<b>INOXPFL05</b>	Racor codo Fig.90 inox 3/4	32
<b>INOXPFL06</b>	Racor codo Fig.90 inox 1"	38
<b>INOXPFL07</b>	Racor codo Fig.90 inox 1.1/4	45
<b>INOXPFL08</b>	Racor codo Fig.90 inox 1.1/2	48
<b>INOXPFL09</b>	Racor codo Fig.90 inox 2	57
<b>INOXPFL10</b>	Racor codo Fig.90 inox 2.1/2	69
<b>INOXPFL11</b>	Racor codo Fig.90 inox 3"	78

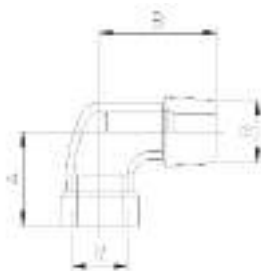

**INOXPEFL: RACOR INOX. CODO MxH CIL. FIG.92**

		<b>A</b>	<b>B</b>
<b>INOXPEFL01</b>	Racor codo Fig.92 MxH inox 1/8	16	22
<b>INOXPEFL02</b>	Racor codo Fig.92 MxH inox 1/4	19	27
<b>INOXPEFL03</b>	Racor codo Fig.92 MxH inox 3/8	23	29
<b>INOXPEFL04</b>	Racor codo Fig.92 MxH inox 1/2	27	35
<b>INOXPEFL05</b>	Racor codo Fig.92 MxH inox 3/4	32	40
<b>INOXPEFL06</b>	Racor codo Fig.92 MxH inox 1"	38	46
<b>INOXPEFL07</b>	Racor codo Fig.92 MxH inox 1.1/4	45	54
<b>INOXPEFL08</b>	Racor codo Fig.92 MxH inox 1.1/2	48	57
<b>INOXPEFL09</b>	Racor codo Fig.92 MxH inox 2	57	70
<b>INOXPEFL10</b>	Racor codo Fig.92 MxH inox 2.1/2	69	83
<b>INOXPEFL11</b>	Racor codo Fig.92 MxH inox 3"	78	94

**RACORES Y COMPLEMENTOS ROSCADOS EN ACERO INOXIDABLE :**

Totalmente fabricados en Acero Inoxidable AISI 316, Rosca BSP cónica Macho y cilíndrica Hembra. Óptimos para complementación en usos industriales en aire comprimido y otro tipo de fluidos. Resistentes al agua, grasa, aceites y químicos (Ver tabla de compatibilidades).



**INOXPFL45: RACOR CODO 45° INOX. CÓNICO HxH**

		<b>A</b>
<b>INOXPFL45-02</b>	Racor codo Fig.120 45° inox1/4	17
<b>INOXPFL45-03</b>	Racor codo Fig.120 45° inox 3/8	19
<b>INOXPFL45-04</b>	Racor codo Fig.120 45° inox 1/2	21
<b>INOXPFL45-05</b>	Racor codo Fig.120 45° inox 3/4	25
<b>INOXPFL45-06</b>	Racor codo Fig.120 45° inox 1"	29
<b>INOXPFL45-07</b>	Racor codo Fig.120 45° inox 1.1/4	33
<b>INOXPFL45-08</b>	Racor codo Fig.120 45° inox 1.1/2	37
<b>INOXPFL45-09</b>	Racor codo Fig.120 45° inox 2	42
<b>INOXPFL45-10</b>	Racor codo Fig.120 45° inox 2.1/2	49



**INOXPFT: RACOR "TE" INOX. HxHxH UNIÓN FIG.130**

		<b>A</b>
<b>INOXPFT01</b>	Racor TE Fig.130 hembra inox 1/8	16
<b>INOXPFT02</b>	Racor TE Fig.130 hembra inox 1/4	19
<b>INOXPFT03</b>	Racor TE Fig.130 hembra inox 3/8	23
<b>INOXPFT04</b>	Racor TE Fig.130 hembra inox 1/2	27
<b>INOXPFT05</b>	Racor TE Fig.130 hembra inox 3/4	32
<b>INOXPFT06</b>	Racor TE Fig.130 hembra inox 1"	38
<b>INOXPFT07</b>	Racor TE Fig.130 hembra inox 1.1/4	45
<b>INOXPFT08</b>	Racor TE Fig.130 hembra inox 1.1/2	48
<b>INOXPFT09</b>	Racor TE Fig.130 hembra inox 2"	57
<b>INOXPFT10</b>	Racor TE Fig.130 hembra inox 2.1/2	69
<b>INOXPFT11</b>	Racor TE Fig.130 hembra inox 3"	78

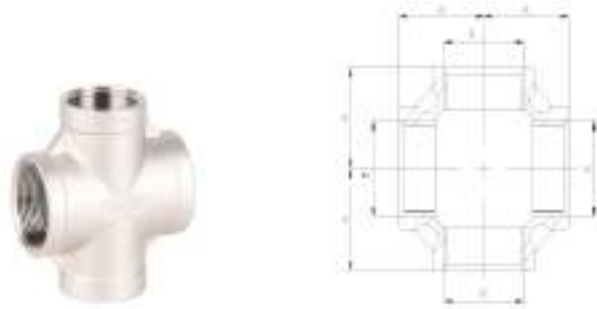

**INOXPFC: RACOR CRUZ INOX HxHxHxH FIG.180**

		<b>A</b>
<b>INOXPFC02</b>	Racor Cruz F.180 hembra inox 1/4	19
<b>INOXPFC03</b>	Racor Cruz F.180 hembra inox 3/8	23
<b>INOXPFC04</b>	Racor Cruz F.180 hembra inox 1/2	27
<b>INOXPFC05</b>	Racor Cruz F.180 hembra inox 3/4	32
<b>INOXPFC06</b>	Racor Cruz F.180 hembra inox 1"	38
<b>INOXPFC07</b>	Racor Cruz F.180 hembra inox 1.1/4	45
<b>INOXPFC08</b>	Racor Cruz F.180 hembra inox 1.1/2	48
<b>INOXPFC09</b>	Racor Cruz F.180 hembra inox 2" 57	57



**INOXPO: RACOR INOX. TAPON MACHO CON. FIG.290**

		<b>L</b>	<b>S</b>
<b>INOXPO-02</b>	Tapón Macho Inox F.290 1/4	14,5	15
<b>INOXPO-03</b>	Tapón Macho Inox F.290 3/8	16	18
<b>INOXPO-04</b>	Tapón Macho Inox F.290 1/2	19,5	23
<b>INOXPO-05</b>	Tapón Macho Inox F.290 3/4	21	28
<b>INOXPO-06</b>	Tapón Macho Inox F.290 1	24	35
<b>INOXPO-07</b>	Tapón Macho Inox F.290 1.1/4	27	44
<b>INOXPO-08</b>	Tapón Macho Inox F.290 1.1/2	27	50
<b>INOXPO-09</b>	Tapón Macho Inox F.290 2	32	62
<b>INOXPO-10</b>	Tapón Macho Inox F.290 2.1/2	34	77
<b>INOXPO-11</b>	Tapón Macho Inox F.290 3	37,5	90

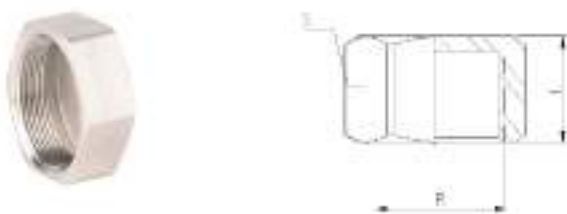

**INOXPOF: RACOR INOX. TAPON H CIL. FIG.300**

		<b>L</b>	<b>S</b>
<b>INOXPOF02</b>	Tapón Hembra Inox F.300 1/4	16	18
<b>INOXPOF03</b>	Tapón Hembra Inox F.300 3/8	16,5	20
<b>INOXPOF04</b>	Tapón Hembra Inox F.300 1/2	21	25
<b>INOXPOF05</b>	Tapón Hembra Inox F.300 3/4	22,5	30
<b>INOXPOF06</b>	Tapón Hembra Inox F.300 1"	26	38
<b>INOXPOF07</b>	Tapón Hembra Inox F.300 1.1/4	29	47
<b>INOXPOF08</b>	Tapón Hembra Inox F.300 1.1/2	29	53
<b>INOXPOF09</b>	Tapón Hembra Inox F.300 2"	33,5	66
<b>INOXPOF10</b>	Tapón Hembra Inox F.300 2.1/2	38,5	82
<b>INOXPOF11</b>	Tapón Hembra Inox F.300 3"	42	96

## RACORES Y COMPLEMENTOS ROSCADOS EN ACERO INOXIDABLE :

Totalmente fabricados en Acero Inoxidable AISI 316, Rosca BSP cónica Macho y cilíndrica Hembra. Óptimos para complementación en usos industriales en aire comprimido y otro tipo de fluidos. Válvula con juntas de teflón PTFE o FKM. Resistentes a químicos (Ver tabla de compatibilidades).



### INOXTUE: TUERCA HEXAGONAL INOX. F312

		L
INOXTUE02	Tuerca inox.316 F312 1/4	7
INOXTUE03	Tuerca inox.316 F312 3/8	7
INOXTUE04	Tuerca inox.316 F312 1/2	8
INOXTUE05	Tuerca inox.316 F312 3/4	9
INOXTUE06	Tuerca inox.316 F312 1"	9
INOXTUE07	Tuerca inox.316 F312 1.1/4	11
INOXTUE08	Tuerca inox.316 F312 1.1/2	12
INOXTUE09	Tuerca inox.316 F312 2"	13

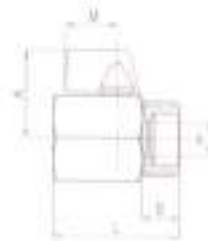

### INOXVHH: VÁLVULA INOX HxH HEXAGONAL MANETA

INOX-VHH02	Válvula INOX Hexagonal Hembra 1/4"HxH
INOX-VHH03	Válvula INOX Hexagonal Hembra 3/8"HxH
INOX-VHH04	Válvula INOX Hexagonal Hembra 1/2"HxH
INOX-VHH05	Válvula INOX Hexagonal Hembra 3/4"HxH
INOX-VHH06	Válvula INOX Hexagonal Hembra 1"HxH

1. Válvula de bola monocuerpo.
2. Extremos roscados M-H DIN 2999 Std.
3. Paso reducido.
4. Construcción en Inox AISI 316 (pulido exterior).
5. Maneta de Aluminio pintado.
6. Presión de trabajo máxima 63 Kg/cm<sup>2</sup>.
7. Temperatura de trabajo -25 °C + 180 °C.



### INOXVHM: VÁLVULA INOX HxM HEXAGONAL MANETA

INOX-VHM02	Válvula INOX Hexagonal Hembra 1/4"HxM
INOX-VHM03	Válvula INOX Hexagonal Hembra 3/8"HxM
INOX-VHM04	Válvula INOX Hexagonal Hembra 1/2"HxM
INOX-VHM05	Válvula INOX Hexagonal Hembra 3/4"HxM
INOX-VHM06	Válvula INOX Hexagonal Hembra 1"HxM

### INOXVBHH: VÁLVULA INOX HxH ESFERA PASO TOTAL PALANCA

INOX-VBHH02	Válvula INOX A316 Esfera 1/4 HxH
INOX-VBHH03	Válvula INOX A316 Esfera 3/8 HxH
INOX-VBHH04	Válvula INOX A316 Esfera paso total 1/2 HxH
INOX-VBHH05	Válvula INOX A316 Esfera paso total 3/4 HxH
INOX-VBHH06	Válvula INOX A316 Esfera paso total 1" HxH
INOX-VBHH07	Válvula INOX A316 Esfera paso total 1.1/4" HxH
INOX-VBHH08	Válvula INOX A316 Esfera paso total 1.1/2" HxH
INOX-VBHH09	Válvula INOX A316 Esfera paso total 2" HxH
INOX-VBHH09	Válvula INOX A316 Esfera paso total 2.1/2" HxH
INOX-VBHH09	Válvula INOX A316 Esfera paso total 3" HxH



### INOXVAT: VALVULA ANTIRRETORNO INOX. HxH

INOX VAT02	Válvula INOX 316 Antirretorno 1/4"HxH
INOX VAT03	Válvula INOX 316 Antirretorno 3/8"HxH
INOX VAT04	Válvula INOX 316 Antirretorno 1/2"HxH
INOX VAT05	Válvula INOX 316 Antirretorno 3/4"HxH
INOX VAT06	Válvula INOX 316 Antirretorno 1"HxH
INOX VAT07	Válvula INOX 316 Antirretorno 1.1/4"HxH
INOX VAT08	Válvula INOX 316 Antirretorno 1.1/2"HxH
INOX VAT09	Válvula INOX 316 Antirretorno 2"HxH
INOX VAT10	Válvula INOX 316 Antirretorno 2.1/2"HxH
INOX VAT11	Válvula INOX 316 Antirretorno 3"HxH



### INOXRAL: REGLETA COLECTOR INOX ENTRADAS 1"H x SALIDAS 1/2"H

INOX RAL0404	Colector Inox.304 Entradas 1"H x 4 Salidas 1/2"H
INOX RAL0504	Colector Inox.304 Entradas 1"H x 5 Salidas 1/2"H
INOX RAL0604	Colector Inox.304 Entradas 1"H x 6 Salidas 1/2"H
INOX RAL0804	Colector Inox.304 Entradas 1"H x 8 Salidas 1/2"H



### DISTRIBUIDORES DE ALUMINIO ROSCADOS

Posibilidad de referencias en aluminio Anodizado (bajo pedido y no todos los modelos), - AL -

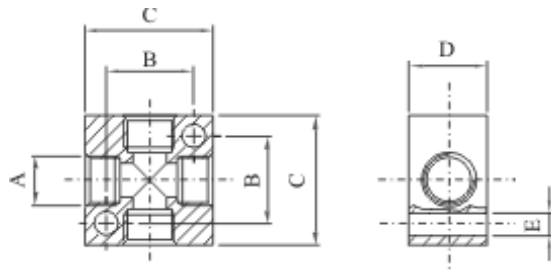

RA: REGLETA ALUMINIO CRUZ 4 SALIDAS

	A	B	C	D	E
RA01	1/8"	17	25	15	4,25
RA02	1/4"	21	30	18	4,25
RA03	3/8"	30	40	20	5,25
RA04	1/2"	37	50	30	6,5

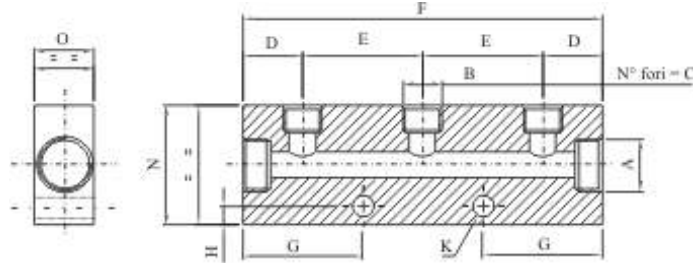

RAL: REGLETA ALUMINIO "L" SALIDAS A UN LADO

	A	C	B	D	E	F	G	N
RAL03M5	1/8"	3 - M5						
RAL04M5	1/8"	4 - M5						
RAL06M5	1/8"	6 - M5						
RAL0201	1/4"	2 - 1/8	15	30	60	30	30	
RAL0301	1/4"	3 - 1/8	15	30	90	30	30	
RAL0401	1/4"	4 - 1/8	15	30	120	30	30	
RAL0501	1/4"	5 - 1/8	15	30	150	30	30	
RAL0601	1/8"	6 - 1/8						
RAL0202	3/8"	2 - 1/4	18	36	72	36	40	
RAL0302	3/8"	3 - 1/4	18	36	108	36	40	
RAL0402	3/8"	4 - 1/4	18	36	144	36	40	
RAL0502	3/8"	5 - 1/4	18	36	180	36	40	
RAL0602	3/8"	6 - 1/4						

RAL: REGLETA ALUMINIO "L" SALIDAS A UN LADO

	A	C	B
RAL0202 (04)	1/2"	2 - 1/4	
RAL0302 (04)	1/2"	3 - 1/4	
RAL0402 (04)	1/2"	4 - 1/4	
RAL0502 (04)	1/2"	5 - 1/4	
RAL0602 (04)	1/2"	6 - 1/4	
RAL0203	1/2"	2 - 3/8	
RAL0303	1/2"	3 - 3/8	
RAL0403	1/2"	4 - 3/8	
RAL0503	1/2"	5 - 3/8	
RAL0603	1/2"	6 - 3/8	
RAL0204	1/2"	2 - 1/2	
RAL0304	1/2"	3 - 1/2	
RAL0404	1/2"	4 - 1/2	
RAL0504	1/2"	5 - 1/2	
RAL0604	1/2"	6 - 1/2	

Nota: Bajo pedido otras posibilidades a consultar

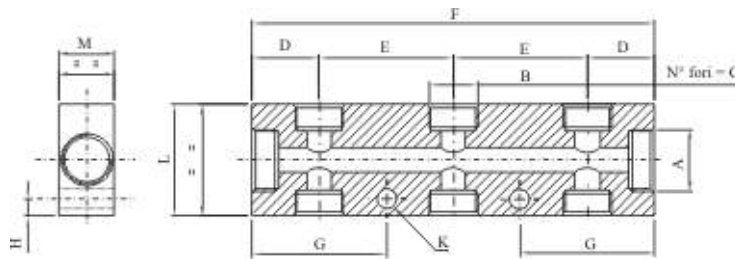

RAT: REGLETA AL.EN "T" SALIDAS AMBOS LADOS

	A	C	B	D	E	F	G	N
RAT04M5	1/8"	4 - M5						
RAT06M5	1/8"	6 - M5						
RAT10M5	1/8"	10 - M5						
RAT0401	1/4"	4 - 1/8	15	30	60	30	30	
RAT0601	1/4"	6 - 1/8	15	30	90	30	30	
RAT0801	1/4"	8 - 1/8	15	30	120	30	30	
RAT1001	1/4"	10 - 1/8	15	30	150	30	30	
RAT0402	3/8"	4 - 1/4	18	36	72	36	40	
RAT0602	3/8"	6 - 1/4	18	36	108	36	40	
RAT0802	3/8"	8 - 1/4	18	36	144	36	40	
RAT1002	3/8"	10 - 1/4	18	36	180	36	40	

RAT: REGLETA AL.EN "T" SALIDAS AMBOS LADOS

	A	C	B
RAT0603 (04)	1/2"	6 - 3/8	
RAT0803 (04)	1/2"	8 - 3/8	
RAT1003 (04)	1/2"	10 - 3/8	
RAT0604 (04)	1/2"	6 - 1/2	
RAT0804 (04)	1/2"	8 - 1/2	
RAT1004 (04)	1/2"	10 - 1/2	

Nota: Otras posibilidades de pasos/salidas a consultar

**SILENCIADORES** NOTA: Todos los modelos disponibles en roscas 3/4" Y 1". Posibilidad de otros modelos a consultar.

**BSLM: SILENCIADOR COMPACTO**

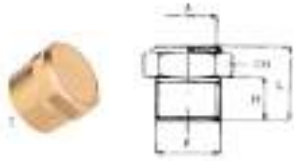

	F	A	H	L	CH
BSLMM5	M5"	7	5	12	8
BSLM01	1/8"	11	6	14	13
BSLM02	1/4"	14	7	17	16
BSLM03	3/8"	17	8	17	19
BSLM04	1/2"	22	10	21	24
BSLM05	3/4"				
BSLM06	1"				

**BSL: SILENCIADOR LARGO**



	F	A	B	H	L
BSLM5	M5	9	4	4	17
BSL01	1/8"	15	8	6	27
BSL02	1/4"	17	8	7	32
BSL03	3/8"	25	7	8	40
BSL04	1/2"	27	9	9	52
BSL05	3/4"	25	7	8	40
BSL06	1"	27	9	9	52

**INOXBSLM: Silenc. malla Inox.  
cuerpo latón cromado**



	F	I	H	CH
INOXBSLM01	1/8"	6	15	13
INOXBSLM02	1/4"	8	18	16
INOXBSLM03	3/8"	8	20	19
INOXBSLM04	1/2"	10	22	24

**BESL: Regulador - Silenciador**

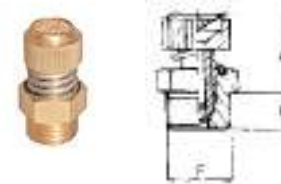

	F	A	A	H	CH
BESL01	1/8"	20	22	6	12
BESL02	1/4"	22	24	8	15
BESL03	3/8"	25	28	10	20
BESL04	1/2"	26	29	11	24
BESL05	3/4"				
BESL06	1"				

**BSLMP: Silen. Plástico malla**



	F	I	H	CH
BSLMP01	1/8"	6	15	13
BSLMP02	1/4"	8	18	16
BSLMP03	3/8"	8	20	19
BSLMP04	1/2"	10	22	24

**BSLP: SILENCIADOR PLASTICO**



	F	A	B	H	L
BSLP01	1/8"	15	27	8	35
BSLP02	1/4"	19	36	9	45
BSLP03	3/8"	24	47	11	58
BSLP04	1/2"	24	47	11	58
BSLP05	3/4"	24	47	11	58
BSLP06	1"	24	47	11	58

**ST : Silenciador CDC de Polietileno Macho**

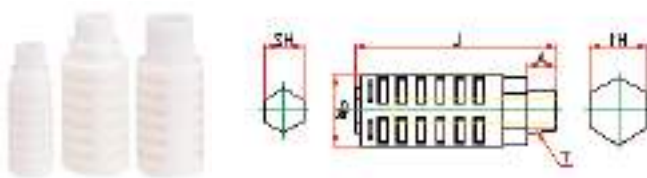

MODELO	P	T	L	A	H1	H2	PESO
ST 01	10.5	R 1/8	35.3	8.0	-	6	11.9
ST 02	22.2	R 1/4	63.0	9.5	18	12	14.1
ST 03	25.0	R 3/8	83.2	13.7	21	15	22.2
ST 04	30.0	R 1/2	88.0	15.5	26	19	31.1
ST 05	45.0	R 3/4	101.0	16.8	33	-	63.7
ST 06	45.0	R 1"	101.0	16.8	33	-	65.4

**VÁLVULAS NEUMÁTICAS DE CIERRE, ANTIRRETORNO, ESCAPE RÁPIDO, REGULADORAS, etc...(pag. siguiente)**

**VHH: VALVULA CIERRE HEXAGONAL MINI  
HxH CILÍNDRICA - BRASS + PTFE**



	F	DN	L	H	CH
VHH01-01	1/8"	8	39	27,5	20
VHH02-02	1/4"	8	39	27,5	20
VHH03-03	3/8"	8	42	27,5	20
VHH04-04	1/2"	10	47	28,9	24
VHH05-05	3/4"	13,5	47	31,8	30

**VHM: VALVULA CIERRE HEXAGONAL MINI  
HxM CILÍNDRICA - BRASS + PTFE**



	F	DN	L	H	CH
VHM01-01	1/8"	8	39	27,5	20
VHM02-02	1/4"	8	39	27,5	20
VHM03-03	3/8"	8	42	27,5	20
VHM04-04	1/2"	10	47	28,9	24
VHM05-05	3/4"	13,5	47	31,8	30

**VÁLVULAS NEUMÁTICAS DE CIERRE, ANTIRRETORNO, ESCAPE RÁPIDO, REGULADORAS...**

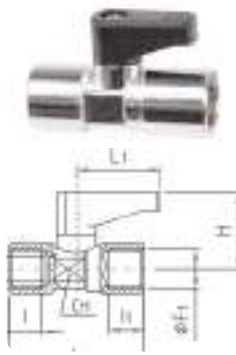

**VHH-C: VÁLVULA BOLA MINI COMPACTA HxH**

	F	H	I	I1	L	L1	CH
VHH01-C	1/8"	21,5	8	8	36,5	19	14
VHH02-C	1/4"	21,5	11	11	43	19	14
VHH03-C	3/8"	22,5	13	16	48	19	18
VHH04-C	1/2"	33	15	15	56	27	22



**VHM-C: VÁLVULA BOLA MINI COMPACTA HxM**

	F	H	I	I1	L	L1	CH
VHM01-C	1/8"	21,5	8	8	35,5	19	14
VHM02-C	1/4"	21,5	11	11	40,5	19	14
VHM03-C	3/8"	22,5	13	16	48	19	18
VHM04-C	1/2"	33	15	15	56	27	22

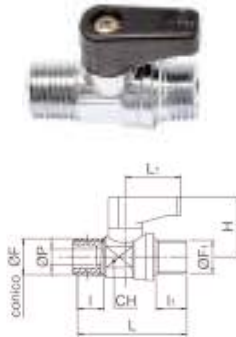

**VMM-C: VÁLVULA BOLA MINI COMPACTA M-cilíndrico x M-cónico**

	F	P	I	I1	L	L1	H	CH
VMM01-C	1/8"	5,5	8	7	33	19,5	21,5	14
VMM02-C	1/4"	5,5	11	7,5	36	19,5	21,5	14
VMM03-C	3/8"	8	13	9	45	19,5	23	18
VMM04-C	1/2"	10	15	8,5	51	26,5	33	22



**VMAN-C: Manetas de colores para VÁLVULAS DE BOLA MINI COMPACTAS**

	F	COLOR
VMAN100R-C	1/8-1/4-3/8	ROJO
VMAN100B-C	1/8-1/4-3/8	AZUL
VMAN100W-C	1/8-1/4-3/8	BLANCO
VMAN100V-C	1/8-1/4-3/8	VERDE
VMAN100G-C	1/8-1/4-3/8	AMARILLO
VMAN200R-C	1/2	ROJO

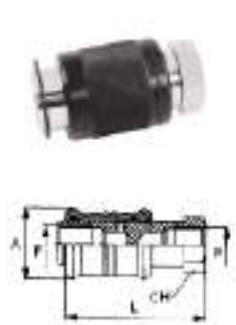

**VC: VÁLVULA CORREDERA C/DESCARGA HxH**

	F	D	I	L	SW
VCM5	M5	14	5	30,5	103
VC01	1/8"	25	9	48	14
VC02	1/4"	30	11,5	58	19
VC03	3/8"	35	12	70	22
VC04	1/2"	40	15	75	27



**VBHH: VÁLVULA ESFERA PASO TOTAL HxH INOXVBHH: Válvula inox (También Disponible)**

	F	L	L(Palanca)	CH
VBHH02	1/4"	45	80	21
VBHH03	3/8"	45	80	21
VBHH04	1/2"	50	80	25
VBHH05	3/4"	59	90	31
VBHH06	1"	70	90	38
VBHH07	1-1/4"	81	115	47
VBHH08	1-1/2"	91	125	54
VBHH09	2"	108	150	66

INOXVBHH02 / 03 / 04 / 05 / 06 / 07 / 08 / 09.



**VAT: VÁLVULA ANTIRRETORNO (Ap.0,5 bar)**

	F	L	CH
VAT01	1/8"HxH	31	13
VAT02	1/4"HxH	37	16
VAT03	3/8"HxH	42	20
VAT04	1/2"HxH	50	25



**VPA: VÁLVULA DE PURGA**

	F	L	CH
VPA01	1/8"M	31	13
VPA02	1/4"M	37	17
VPA03	3/8"M	42	20
VPA04	1/2"M	50	25

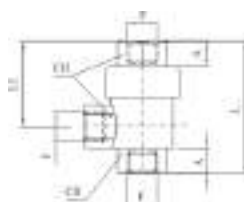

**VRE: REGULADOR DE CAUDAL UNIDIRECCIONAL HxH**

	F	L	ALT	CH
VRE01	1/8"HxH	31	22	16
VRE02	1/4"HxH	45	30	16
VRE03	3/8"HxH	50	30	20
VRE04	1/2"HxH	59	40	20

**VES: VÁLVULA DE RETENCIÓN HxHxH CILÍNDRICA**

	F	I	H	H1	CH	CH1	E
VES01	1/8"	8	42	28	14	14	19,5
VES02	1/4"	11	53	34,5	19	19	25
VES03	3/8"	12	58	36	21	21	26
VES04	1/2"	14	71	44	26	26	35
VES05	3/4"	18	86	52	32	32	38,5

**CB01: PISTOLAS PLÁSTICO C/CAÑAS**

CB01-100	Pistola plástico caña corta 100 mm
CB01-200	Pistola plástico caña media 200 mm
CB01-300	Pistola plástico caña larga 300 mm



**CA: PISTOLAS PLÁSTICO Y ALUMINIO (AG = MODELO CA- DE LA MARCA CDC)**

CA-50	Pistola plástico caña corta 50mm
CA-100	Pistola plástico caña corta 100 mm
CA-200	Pistola plástico caña media 200 mm
CA-300	Pistola plástico caña larga 300 mm
AIR-Duster	Pistola Aluminio 1/4H c/boquilla



**CORTATUBOS - SELLADORES**

ETC-20	Cortatubo seguridad cinta métrica
C0001	Cortatubo Pinza 12mm
AIRTINBOK	Acoplador hinchar c/espiga 6mm
C0002	Cortatubo Tenaza 12mm
C0003	Cortatubo Tenaza 25mm
TEFLON	Cinta teflón rollo 12 mts
RES-2075	Bote sellador 75 ml líquido

## ENCHUFES RÁPIDOS UNIVERSALES Y ACOPLADORES DN.7,2

UMU - UHU: Norma USA ISO6150B-DN 5,5 UMD - UHD: Norma Europea o Alemana DN 7,2

### UNI: ENCHUFE RÁPIDO UNIVERSAL LATÓN ROSCA MACHO, HEMBRA Y ESPIGA P/MANGUERA

	F	L	D	L1	SW
UNIM01	1/8M	54	24	10	20
UNIM02	1/4M	58	24	11	20
UNIM03	3/8M	54	24	11,5	20
UNIM04	1/2M	56,5	24	14	22
UNIH01	1/8H	55	24	10	20
UNIH02	1/4H	55	24	11	20
UNIH03	3/8H	55	24	12	20
UNIH04	1/2H	55	28	14	25
UNIE06	6	67	24	15	20
UNIE08	8	67	24	20	20
UNIE10	10	67	24	20	20
UNIE12	12	67	24	20	20

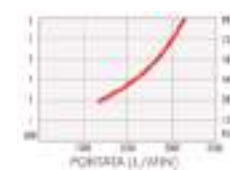
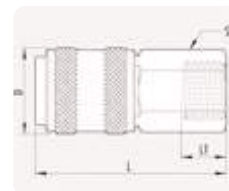
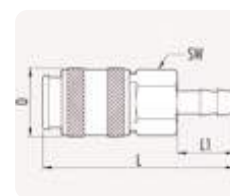
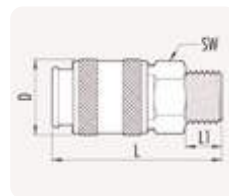

### UMU: ACOPLADOR EN. RÁPIDO AMERICANO UMD: ACOPLADOR EN. RÁPIDO EUROPEO ROSCA MACHO



- UMU02 Espiga 7,9mm p/enchufe rápido 1/4"M
- UMU03 Espiga 7,9mm p/enchufe rápido 3/8"M
- UMU04 Espiga 7,9mm p/enchufe rápido 1/2"M

- UMD02 Espiga 9,9mm p/enchufe rápido 1/4"M
- UMD03 Espiga 9,9mm p/enchufe rápido 3/8"M
- UMD04 Espiga 9,9mm p/enchufe rápido 1/2"M



### UHU: ACOPLADOR EN. RÁPIDO AMERICANO UHD: ACOPLADOR EN. RÁPIDO EUROPEO ROSCA HEMBRA

- UHU02 Espiga 7,9mm p/enchufe rápido 1/4"H
- UHU03 Espiga 7,9mm p/enchufe rápido 3/8"H
- UHU04 Espiga 7,9mm p/enchufe rápido 1/2"H

- UHD02 Espiga 9,9mm p/enchufe rápido 1/4"H
- UHD03 Espiga 9,9mm p/enchufe rápido 3/8"H
- UHD04 Espiga 9,9mm p/enchufe rápido 1/2"H

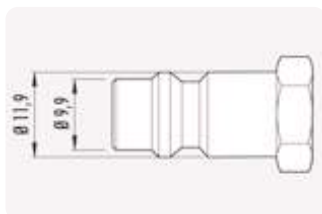
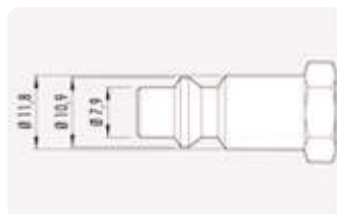

### UEU: ACOPLADOR EN. RÁPIDO AMERICANO UED: ACOPLADOR EN. RÁPIDO EUROPEO ESPIGA P/ MANGUERA

- UEU06 Espiga 7,9mm p/manguera Ø6
- UEU08 Espiga 7,9mm p/manguera Ø8
- UEU10 Espiga 7,9mm p/manguera Ø10

- UED06 Espiga 9,9mm p/manguera Ø6
- UED08 Espiga 9,9mm p/manguera Ø8
- UED10 Espiga 9,9mm p/manguera Ø10



### URU: ACOPLADOR EN. RÁPIDO AMERICANO ESPIGA C/MUELLE P/TUBO

- URU06 Espiga 7,9mm p/tubo Ø6x4mm
- URU08 Espiga 7,9mm p/tubo Ø8x5mm
- URU10 Espiga 7,9mm p/tubo Ø10x6,5mm
- URU12 Espiga 7,9mm p/tubo Ø12x8mm

### ENCHUFES RÁPIDOS UNIVERSALES Y ACOPLADORES PASO MEDIO 5mm

- UNIRM01 - UNIRM02: Enchufes Rosca macho 1/8 y 1/4
- UNIRH01 - UNIRH02: Enchufes Rosca hembra 1/8 y 1/4
- UNIRE06 - UNIRE08: Enchufes p/manguera de 6 y 8mm
- UMUR01 - UMUR02: Acopladores 5mm Rosca macho 1/8 y 1/4
- UHUR01 - UHUR02: Acopladores 5mm Rosca hembra 1/8 y 1/4
- UEUR06 - UEUR08: Acopladores p/manguera de 6 y 8mm

## ENCHUFES DE SEGURIDAD UNIVERSALES

Compatibles UMU - UHU: Norma USA ISO6150B-DN 5,5 UMD - UHD: Norma Europea o Alemana DN 7,2 DN 7,2 Italiana y Suiza.

### UNIS: ENCHUFE SEGURIDAD UNIVERSAL LATÓN ROSCA MACHO, HEMBRA Y ESPIGA P/MANGUERA

	F	L	D	L1	SW
UNISM-02	1/4M	71	20	14	20
UNISM-03	3/8M	73	20	19	20
UNISM-04	1/2M	76	20	24	22
UNISH-02	1/4H	58	20	11	20
UNISH-03	3/8H	72	20	12	20
UNISH-04	1/2H	75	20	14	25
UNISE-06	6	82	20	31	20
UNISE-08	8	83	24	32	20
UNISE-10	10	83	24	32	20
UNISE-12	12	83	24	32	20

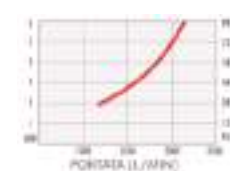
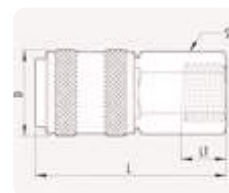
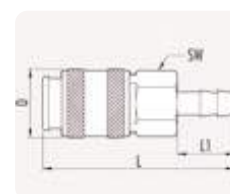
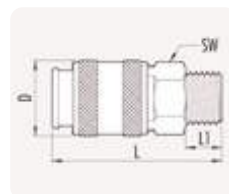

**GRUPOS DE FILTRAJE MODULAR F-R-L y MANÓMETROS**

**FR: REGULADOR DE PRESIÓN Hembra**



<b>FR02</b>	Regulador de presión 1/4"
<b>FR04</b>	Regulador de presión 1/2"
<b>FR06</b>	Regulador de presión 1"

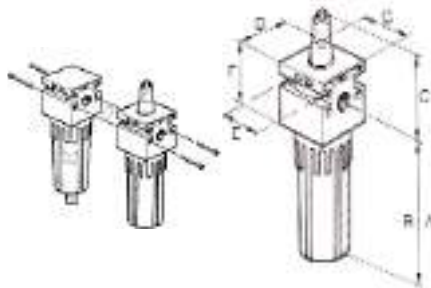
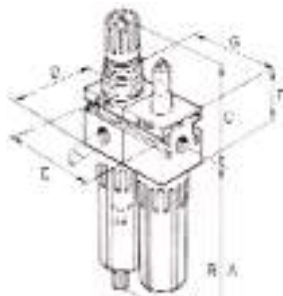
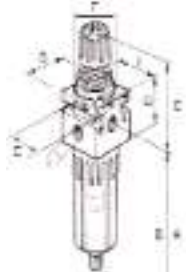

**Para líneas neumáticas.**

**FFI: FILTRO VASO METALICO Hembra**



<b>FFI02</b>	Filtro vaso metal purga S/A 1/4" 32 M
<b>FFI02-5M</b>	Filtro vaso metal purga S/A 1/4" 5 Mcr
<b>FFI04</b>	Filtro vaso metal purga S/A 1/2"
<b>FFI06</b>	Filtro vaso metal purga S/A 1"

**FFR: FILTRO - REGULADOR VASO METALICO HxH 32- 5 y 0,1 Micras 18Bar**  
T.Máx. 50°C ISO- E-UNI FD22 Caudal: 1/4: 700 l/min 1/2: 2600 l/min 1":4600 l

	R	A	C	D	E	F	G	I	L	Peso (Kg)
<b>FFR02</b>	1/4" 32M	117	64	42	32	30	42	42	1/8	0,350
<b>FFR02-5M</b>	1/4" 5 M									
<b>FFR04</b>	1/2" 32 M	149	78	60	46	38	60	60	1/8	0,900
<b>FFR04-5M</b>	1/2" 5 M									
<b>FFR06</b>	1" 32 M	195	129	80	66	50	80	80	1/4	2,500

**FFRL: FILTRO-REGULADOR + LUBRICADOR 32- 5 y 0,1 Micras 18Bar**  
T.Máx. 50°C ISO- E-UNI FD22 Caudal: 1/4: 600 l/min 1/2: 2250 l/min 1":4300 l

	R	A	C	D	E	F	G	L	Peso (Kg)
<b>FFRL02</b>	1/4" 32M	117	64	42	76	42	84	1/8	0,350
<b>FFRL02-5M</b>	1/4" 5 M								
<b>FFRL04</b>	1/2" 32 M	149	78	60	109	60	120	1/8	2,000
<b>FFRL04-5M</b>	1/2" 5 M								
<b>FFRL06</b>	1" 32 M	195	129	80	146	80	60	1/4	4,000

NOTA: DISPONEMOS RECAMBIOS, ACEITE, ETC PARA TODOS LOS MODELOS (Bajo pedido, Consultar)

**FLU: LUBRICADOR VASO METÁLICO HxH**  
18 Bar P.Máx. T. Máx. 50°C ISO- E UNI FD22

	R	A	C	D	E	G	Peso (Kg)
<b>FLU02</b>	1/4"	105	50	42	32	42	0,300
<b>FLU04</b>	1/2"	133	60	60	46	60	0,700
<b>FLU06</b>	1"	185	85	80	66	80	1,600

CAUDALES:	FLU02	1150 lts/min	Soporte pared:	M4x40
	FLU04	4300 lts/min	" "	M4x50
	FLU06	9600 lts/min	" "	M6x75

**M40 - M50 - M63: MANÓMETRO CAJA PLÁSTICO SALIDA POSTERIOR**  
-20 +60°C P >2,5 Bar >1,6 Bar (bajo pedido) Grado P. IP43

Bar	F	A	D	E	E1	G	SW	PESO
<b>M4004</b>	0-4	1/8	26	40	42	46	10 14	60gr
<b>M4006</b>	0-6	1/8	26	40	42	46	10 14	60gr
<b>M4010</b>	0-10	1/8	26	40	42	46	10 14	60gr
<b>M4012</b>	0-12	1/8	26	40	42	46	10 14	60gr
<b>M4016</b>	0-16	1/8	26	40	42	46	10 14	60gr
<b>M5004</b>	0-4	1/4	27	50	47	49	10 14	79gr
<b>M5006</b>	0-6	1/4	27	50	47	49	10 14	79gr
<b>M5010</b>	0-10	1/4	27	50	47	49	10 14	79gr
<b>M5012</b>	0-12	1/4	27	50	47	49	10 14	79gr
<b>M5016</b>	0-16	1/4	27	50	47	49	10 14	79gr
<b>M6306</b>	0-6	1/4	29	62	56	53	10 14	113gr
<b>M6310</b>	0-10	1/4	29	62	56	53	10 14	113gr
<b>M6320</b>	0-20	1/4	29	62	56	53	10 14	113gr

**MR40 - MR50 - MR63: MANÓMETRO CAJA PLÁSTICO SALIDA RADIAL**  
-20 +60°C P >2,5 Bar >1,6 Bar (bajo pedido) Grado P. IP43

Bar	F	A	D	E	E1	G	SW	PESO
<b>MR4004</b>	0-4	1/8	26	40	42	46	10 14	60gr
<b>MR4006</b>	0-6	1/8	26	40	42	46	10 14	60gr
<b>MR4010</b>	0-10	1/8	26	40	42	46	10 14	60gr
<b>MR4012</b>	0-12	1/8	26	40	42	46	10 14	60gr
<b>MR4016</b>	0-16	1/8	26	40	42	46	10 14	60gr
<b>MR5004</b>	0-4	1/4	27	50	47	49	10 14	79gr
<b>MR5006</b>	0-6	1/4	27	50	47	49	10 14	79gr
<b>MR5010</b>	0-10	1/4	27	50	47	49	10 14	79gr
<b>MR5012</b>	0-12	1/4	27	50	47	49	10 14	79gr
<b>MR5020</b>	0-20	1/4	27	50	47	49	10 14	79gr
<b>MR6306</b>	0-6	1/4	29	62	56	53	10 14	113gr
<b>MR6310</b>	0-10	1/4	29	62	56	53	10 14	113gr
<b>MR6320</b>	0-20	1/4	29	62	56	53	10 14	113gr

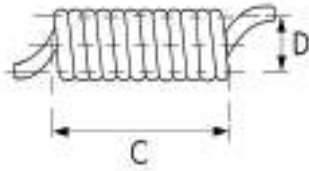

**MPF: RACOR P/ESPIRAL FIJO C/MUELLE**  
**MPG: RACOR P/ESPI. GIRATORIO C/MUELLE**



<b>MPF0802</b>	RAC. Macho Fijo Ø8 1/4
<b>MPF1002</b>	RAC. Macho Fijo Ø10 1/4
<b>MPF1202</b>	RAC. Macho Fijo Ø12 1/4
<b>MPG0602</b>	RAC. Macho Giratorio Ø6 1/4
<b>MPG0802</b>	RAC. Macho Giratorio Ø8 1/4
<b>MPG1002</b>	RAC. Macho Giratorio Ø10 1/4
<b>MPG1202</b>	RAC. Macho Giratorio Ø12 1/4
<b>MPG1203</b>	RAC. Macho Giratorio Ø12 3/8

**SPIR: ESPIRAL DE POLIURETANO AZUL CDC PNEUMATICS (Sin Racores)**

Dureza recomendada por fabricante 98sh. Diámetro del tubo recomendado por el fabricante para la torsión, presión y conexionado con racores. Montaje con racores serie MPF - MPG a elegir (Montaje gratuito).

		C	D.i	D.e	L-util
<b>SPIR0604A</b>	Espiral poliuretano Azul tubo 6 - 3 mts	100	38	55	1,4mt
<b>SPIR0605A</b>	Espiral poliuretano Azul tubo 6 - 5 mts	200	38	55	3,8mt
<b>SPIR0805A</b>	Espiral poliuretano Azul tubo 8 - 5 mts	300	45	63	3,5mt
<b>SPIR0808A</b>	Espiral poliuretano Azul tubo 8 - 7,5 mts	600	45	63	5,5mt
<b>SPIR0810A</b>	Espiral poliuretano Azul tubo 8 - 10 mts	700	45	63	7,5mt
<b>SPIR1005A</b>	Espiral poliuretano Azul tubo 10 - 5 mts	300	45	68	3,5mt
<b>SPIR1008A</b>	Espiral poliuretano Azul tubo 10 - 7,5 mts	580	45	68	5,5mt
<b>SPIR1010A</b>	Espiral poliuretano Azul tubo 10 - 10 mts	600	45	68	7,5mt
<b>SPIR1205A</b>	Espiral poliuretano Azul tubo 12 - 5 mts	300	65	95	3,5mt
<b>SPIR1208A</b>	Espiral poliuretano Azul tubo 12 - 7,5 mts	500	65	95	5,5mt
<b>SPIR1210A</b>	Espiral poliuretano Azul tubo 12 - 10 mts	600	65	95	7,5mt

**TUBO CDC PNEUMATICS POLIURETANO FLEXIBLE 98 SH-A P/Aire comprimido hasta 12 bar**

Colores disponibles: A: azul N: negro R: rojo C: transparente V: verde AM: amarillo AT: azul transparente G: Gris B: Blanco

**TUBO DE POLIURETANO CDC PNEUMATICS**

Dureza recomendada 98 SH -40°C + 80°C

Diámetros de seguridad recomendados por el fabricante para la torsión, presión y conexionado con racores Inst.

<b>AP0425R200</b>	Tubo CDC Pur.98Sh Azul 2,5x4 Rol 200 Mt
<b>AP0604R100</b>	Tubo CDC Pur.98Sh Azul 4x6 Rol 100 Mt
<b>AP0855R100</b>	Tubo CDC Pur.98Sh Azul 5,5x8 Rol 100 Mt
<b>AP1065R100</b>	Tubo CDC Pur.98Sh Azul 6,5x10 Rol 100 Mt
<b>AP1208R100</b>	Tubo CDC Pur.98Sh Azul 8x12 Rol 100 Mt
<b>AP1411R50</b>	Tubo CDC Pur.98Sh Azul 10x14 Rol 50 Mt
<b>AP1612R50</b>	Tubo CDC Pur.98Sh Azul 12x16 Rol 50 Mt

<b>NP0425R200</b>	Tubo CDC Pu.98Sh Negro 2,5x4 Rol 200 Mt
<b>NP0604R100</b>	Tubo CDC Pu.98Sh Negro 4x6 Rol 100 Mt
<b>NP0855R100</b>	Tubo CDC Pu.98Sh Negro 5,5x8 Rol 100 Mt
<b>NP1065R100</b>	Tubo CDC Pu.98Sh Negro 6,5x10 Rol 100Mt
<b>NP1208R100</b>	Tubo CDC Pu.98Sh Negro 8x12 Rol 100 Mt
<b>NP1612R50</b>	Tubo CDC Pu.98Sh Negro 12x16 Rol 50 Mt

<b>RP0425R200</b>	Tubo CDC Pu.98Sh Rojo 2,5x4 Rol 200 Mt
<b>RP0604R100</b>	Tubo CDC Pu.98Sh Rojo 4x6 Rol 100 Mt
<b>RP0855R100</b>	Tubo CDC Pu.98Sh Rojo 5,5x8 Rol 100 Mt
<b>RP1065R100</b>	Tubo CDC Pu.98Sh Rojo 6,5x10 Rol 100 Mt
<b>RP1208R100</b>	Tubo CDC Pu.98Sh Rojo 8x12 Rol 100 Mt
<b>RP1612R50</b>	Tubo CDC Pu.98Sh Rojo 12x16 Rol 50 Mt

<b>CP0425R200</b>	Tubo CDC 98 Transparente 2,5x4 RI 200 mt
<b>CP0604R100</b>	Tubo CDC 98 Transparente 4x6 Rol 100 Mt
<b>CP0855R100</b>	Tubo CDC 98 Transparente 5,5x8 Rol 100
<b>CP1065R100</b>	Tubo CDC 98 Transparente 6,5x10 Rol 100
<b>CP1208R100</b>	Tubo CDC 98 Transparente 8x12 Rol 100

<b>VP0604R100</b>	Tubo CDC Pu.98 Verde 4x6 Rol 100 Mt
<b>VP0855R100</b>	Tubo CDC Pu.98 Verde 5,5x8 Roll 100 Mt
<b>VP1065R100</b>	Tubo CDC Pu.98 Verde 6,5x10 Rol 100 Mt
<b>VP1208R100</b>	Tubo CDC Pu.98 Verde 8x12 Rol 100 Mt

<b>AMP0604R100</b>	Tubo CDC 98 Amarillo 4x6 Rol 100 Mt
<b>AMP0855R100</b>	Tubo CDC 98 Amarillo 5,5x8 Roll 100 Mt
<b>AMP1065R100</b>	Tubo CDC 98 Amarillo 6,5x10 Rol 100 Mt

<b>AT0425R200</b>	Tubo CDC 98 Azul Transparente 2,5x4 RI 200 mt
<b>AT0604R100</b>	Tubo CDC 98 Azul Transparente 4x6 RI 100 Mt
<b>AT0855R100</b>	Tubo CDC 98 Azul Transparente 5,5x8 Rol 100
<b>AT1065R100</b>	Tubo CDC 98 Azul Transparente 6,5x10 Rol 100
<b>AT1208R100</b>	Tubo CDC 98 Azul Transparente 8x12 Rol 100

<b>GP0425R200</b>	Tubo CDC Pu.98 Gris 2,5x4 Rol 200 Mt
<b>GP0604R100</b>	Tubo CDC Pu.98 Gris 4x6 Rol 100 Mt
<b>GP0855R100</b>	Tubo CDC Pu.98 Gris 5,5x8 Roll 100 Mt
<b>GP1065R100</b>	Tubo CDC Pu.98 Gris 6,5x10 Rol 100 Mt
<b>GP1208R100</b>	Tubo CDC Pu.98 Gris 8x12 Rol 100 Mt

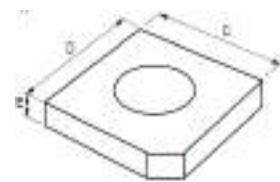

**PACK TUBO DE POLIURETANO CDC PNEUMATICS**

1 Sola caja estandarizada para toda las medidas de tubo  
Medidas Caja: C:43 x D:43 x E:9 cms.

<b>AP0425P50</b>	Tubo CDC Pur.98Sh Azul 2,5x4 Pack 50Mt
<b>AP0604P25</b>	Tubo CDC Pur.98Sh Azul 4x6 Pack 25 Mt
<b>AP0855P25</b>	Tubo CDC Pur.98Sh Azul 5,5x8 Pack 25 Mt
<b>AP1065P25</b>	Tubo CDC Pur.98Sh Azul 6,5x10 Pack 25 Mt
<b>AP1208P25</b>	Tubo CDC Pur.98Sh Azul 8x12 Pack 25 Mt
<b>AP1410P25</b>	Tubo CDC Pur.98Sh Azul 10x14 Bolsa 25 Mt
<b>AP1612P25</b>	Tubo CDC Pur.98Sh Azul 12x16 Bolsa 25 Mt

<b>NP0425P50</b>	Tubo CDC Pur.98Sh Negro 2,5x4 Pack 50Mt
<b>NP0604P25</b>	Tubo CDC Pur.98Sh Negro 4x6 Pack 25 Mt
<b>NP0855P25</b>	Tubo CDC Pur.98Sh Negro 5,5x8 Pack 25 Mt
<b>NP1065P25</b>	Tubo CDC Pur.98Sh Negro 6,5x10 Pack 25 Mt
<b>NP1208P25</b>	Tubo CDC Pur.98Sh Negro 8x12 Pack 25 Mt
<b>NP1612P25</b>	Tubo CDC Pur.98Sh Negro 12x16 Bolsa 25 Mt

<b>RP0425P50</b>	Tubo CDC Pur.98Sh Rojo 2,5x4 Pack 50Mt
<b>RP0604P25</b>	Tubo CDC Pur.98Sh Rojo 4x6 Pack 25 Mt
<b>RP0855P25</b>	Tubo CDC Pur.98Sh Rojo 5,5x8 Pack 25 Mt
<b>RP1065P25</b>	Tubo CDC Pur.98Sh Rojo 6,5x10 Pack 25 Mt
<b>RP1208P25</b>	Tubo CDC Pur.98Sh Rojo 8x12 Pack 25 Mt
<b>RP1612P25</b>	Tubo CDC Pur.98Sh Rojo 12x16 Bolsa 25 Mt

<b>CP0425P50</b>	Tubo CDC Pur.98Sh Transparente 2,5x4 P 50Mt
<b>CP0604P25</b>	Tubo CDC Pur.98Sh Transparente 4x6 P 25 Mt
<b>CP0855P25</b>	Tubo CDC Pur.98Sh Transparente 5,5x8 P 25
<b>CP1065P25</b>	Tubo CDC Pur.98Sh Transparente 6,5x10 P 25
<b>CP1208P25</b>	Tubo CDC Pur.98Sh Transparente 8x12 P 25 Mt

<b>VP0604P25</b>	Tubo CDC Pu.98 Verde 4x6 P 25 Mt
<b>VP0855P25</b>	Tubo CDC Pu.98 Verde 5,5x8 P 25 Mt
<b>VP1065P25</b>	Tubo CDC Pu.98 Verde 6,5x10 P 25 Mt
<b>VP1208P25</b>	Tubo CDC Pu.98 Verde 8x12 P 25 Mt

<b>AMP0604P25</b>	Tubo CDC 98 Amarillo 4x6 Pack 25 Mt
<b>AMP0855P25</b>	Tubo CDC 98 Amarillo 5,5x8 Pack 25 Mt
<b>AMP1065P25</b>	Tubo CDC 98 Amarillo 6,5x10 Pack 25 Mt

**TUBO PUR 98SH EN PULGADAS color AZUL rollos**

<b>AP5/32R</b>	PUR Azul 5/32" R.200 mt
<b>AP3/16R</b>	PUR Azul 3/16" R100 mt
<b>AP1/4R</b>	PUR Azul 1/4" R100 mt
<b>AP5/16R</b>	PUR Azul 5/16" R.100 mt
<b>AP3/8R</b>	PUR Azul 3/8" R100 mt
<b>AP1/2R</b>	PUR Azul 1/2" R100 mt

<b>AT0425P50</b>	Tubo CDC Pur.98Sh Azul Tr. 2,5x4 Pack 50Mt
<b>AT0604P25</b>	Tubo CDC Pur.98Sh Azul Tr.4x6 Pack 25 Mt
<b>AT0855P25</b>	Tubo CDC Pur.98Sh Azul Tr.5,5x8 Pack 25 Mt
<b>AT1065P25</b>	Tubo CDC Pur.98Sh Azul Tr.6,5x10 Pack 25 Mt
<b>AT1208P25</b>	Tubo CDC Pur.98Sh Azul Tr. 8x12 Pack 25 Mt

<b>GP0425P50</b>	Tubo CDC Pur.98Sh Gris 2,5x4 Pack 50Mt
<b>GP0604P25</b>	Tubo CDC Pur.98Sh Gris 4x6 Pack 25 Mt
<b>GP0855P25</b>	Tubo CDC Pur.98Sh Gris 5,5x8 Pack 25 Mt
<b>GP1065P25</b>	Tubo CDC Pur.98Sh Gris 6,5x10 Pack 25 Mt
<b>GP1208P25</b>	Tubo CDC Pur.98Sh Gris 8x12 Pack 25 Mt

## TUBERIAS PARA APLICACIONES INDUSTRIALES:

PA12; PTFE; FEP; PVDF; PE-BD; Manguera 20 bar; Mang. CRISTAL, SYNFLEX 1300 (Dekabon), Mangueras p/Transporte neumático. Otras tuberías técnicas a consultar.



### POLIAMIDA PA12 -40 +110°C DIN 74324 P.S.

<a href="#">BN0427R</a>	Tubo PA12 natural 4x2,7 Rollo 100 mts	35
<a href="#">BN0604R</a>	Tubo PA12 natural 6x4 Rollo 100 mts	30
<a href="#">BN0806R</a>	Tubo PA12 natural 8x6 Rollo 100 mts	21
<a href="#">BN1008R</a>	Tubo PA12 natural 10x08 Rollo 100 mts	17
<a href="#">BN1210R</a>	Tubo PA12 natural 12x10 Rollo 100 mts	13
<a href="#">BN1412R</a>	Tubo PA12 natural 14x12 Rollo 100 mts	13
<a href="#">BN1511R</a>	Tubo PA12 natural 15x11 Rollo 100 mts	13
<a href="#">BN1613R</a>	Tubo PA12 natural 16x13 Rollo 50/100	13
<a href="#">BN2218R</a>	Tubo PA12 natural 22x18 Rollo 50 mts	13

<a href="#">BN0427P</a>	Tubo PA12 natural 4x2,7 Pack 25 mts	35
<a href="#">BN0604P</a>	Tubo PA12 natural 6x4 Pack 25 mts	30
<a href="#">BN0806P</a>	Tubo PA12 natural 8x6 Pack 25 mts	21
<a href="#">BN1008P</a>	Tubo PA12 natural 10x8 Pack 25 mts	17
<a href="#">BN1210P</a>	Tubo PA12 natural 12x10 Pack 25 mts	13

<a href="#">NN0427R</a>	Tubo PA12 Negro 4x2,7 Rollo 100 mts	35
<a href="#">NN0604R</a>	Tubo PA12 Negro 6x4 Rollo 100 mts	30
<a href="#">NN0806R</a>	Tubo PA12 Negro 8x6 Rollo 100 mts	21
<a href="#">NN1008R</a>	Tubo PA12 Negro 10x08 Rollo 100 mts	17
<a href="#">NN1210R</a>	Tubo PA12 Negro 12x10 Rollo 100 mts	13

<a href="#">AN0604R</a>	Tubo PA12 Azul 6x4 Rollo 100 mts	30
<a href="#">AN0806R</a>	Tubo PA12 Azul 8x6 Rollo 100 mts	21
<a href="#">AN1008R</a>	Tubo PA12 Azul 10x08 Rollo 100 mts	17

### TUBO PVDF Polifloruro de Vinilideno

<a href="#">PVDF0402</a>	Tubo PVDF Traslúcido 4x2 50 mts	
<a href="#">PVDF0604</a>	Tubo PVDF Traslúcido 6x4 50 mts	
<a href="#">PVDF0806</a>	Tubo PVDF Traslúcido 8x6 50 mts	
<a href="#">PVDF1008</a>	Tubo PVDF Traslúcido 10x8 50 mts	
<a href="#">PVDF1210</a>	Tubo PVDF Traslúcido 12x10 100 mts	

De -50 a 140°C. Presión de servicio 14bar  
En medidas pequeñas la presión puede ser mayor.  
Norm. FDA Buena resistencia Alcoholes, Acidos, etc



### REGLETA PORTATUBOS PLÁSTICO

<a href="#">RZ0410</a>	Regleta portatubos 4mm ext. x 10f	
<a href="#">RZ0610</a>	Regleta portatubos 6mm ext. x 10f	
<a href="#">RZ0810</a>	Regleta portatubos 8mm ext. x 10f	
<a href="#">RZ1010</a>	Regleta portatubos 10mm ext. x 10f	
<a href="#">RZ1204</a>	Regleta portatubos 12mm ext. x 4f	



### MANGUERA CRISTAL 15 bar ALIMENTARIA

<a href="#">CMG612</a>	Manguera Cristal 15 bar 6x13 Rollo 50 mt	
<a href="#">CMG814</a>	Manguera Cristal 15 bar 8x14 Rollo 50 mt	
<a href="#">CMG1016</a>	Manguera Cristal 15 bar 10x16 Rollo 50 mt	
<a href="#">CMG1218</a>	Manguera Cristal 15 bar 12x18 Rollo 50 mt	
<a href="#">CMG1521</a>	Manguera Cristal 15 bar 15x21 Rollo 50 mt	
<a href="#">CMG1926</a>	Manguera Cristal 15 bar 19x26 Rollo 50 mt	
<a href="#">CMG2532</a>	Manguera Cristal 15 bar 25x32 Rollo 50 mt	

Manguera PVC trenzada atóxica p/industria alimentaria



### MANGUERA P/TRANSPORTE NEUMÁTICO ATÓXICA Interior liso Rollos 25 mts

<a href="#">MATX2532</a>	Manguera transporte 25x32 Rollo 50 mt	
<a href="#">MATX3848</a>	Manguera transporte 38x48 Rollo 50 mt	
<a href="#">MATX5064</a>	Manguera transporte 50x64 Rollo 50 mt	
<a href="#">MATX7588</a>	Manguera transporte 75x88 Rollo 50 mt	
<a href="#">MATX100</a>	Manguera transporte 100x116 Rollo 50 mt	
<a href="#">MATX150</a>	Manguera transporte 150x168 Rollo 50 mt	

Manguera PVC con espiral de acero - Industria alimentaria



### TUBO PTFE Nr. FDA Din 53455 D.60sh

<a href="#">PTFE0402</a>	Tubo Natural PTFE 4x2	
<a href="#">PTFE0604</a>	Tubo Natural PTFE 6x4	
<a href="#">PTFE0806</a>	Tubo Natural PTFE 8x6	
<a href="#">PTFE1008</a>	Tubo Natural PTFE 10x8	
<a href="#">PTFE1210</a>	Tubo Natural PTFE 12x10	
<a href="#">PTFE1412</a>	Tubo Natural PTFE 14x12	
<a href="#">PTFE1614</a>	Tubo Natural PTFE 16x14	
<a href="#">PTFE2219</a>	Tubo Natural PTFE 22x19	

Rollos de 100mt, 50mts ó pack de 25mts. (consultar x medida) Temp. de -200 a 250°C.  
Presión de servicio 14 bar. Posibilidad otros diámetros.

### TUBO FEP Fluoropolímero (alternativa al PTFE)

<a href="#">FEP0402</a>	Tubo FEP Semitransparente 4x2 Rollo 100mt	
<a href="#">FEP0604</a>	Tubo FEP Semitransparente 6x4 R.100mt	
<a href="#">FEP0806</a>	Tubo FEP Semitransparente 8x6 R.100 mt	
<a href="#">FEP1008</a>	Tubo FEP Semitransparente 10x8 R.100mt	
<a href="#">FEP1210</a>	Tubo FEP Semitransparente 12x10 R.100mt	

Buena resistencia química. Oxígeno, ozono, UV, flexible.  
De -60 a 200°C. Presión de servicio 22bar. Norm. FDA  
En medidas pequeñas la presión puede ser mayor.



### TUBO PE-BD Polietileno Baja Densidad

<a href="#">PE-BD0604</a>	Tubo PE Natural 6x4 R.100 mt	
<a href="#">PE-BD0806</a>	Tubo PE Natural 8x6 R100 mt	
<a href="#">PE-BD1008</a>	Tubo PE Natural 10x8 R100 mt	
<a href="#">PE-BD1210</a>	Tubo PE Natural 12x10 R100 mt	
<a href="#">PE-BD1512</a>	Tubo PE Natural 15x12 R100 mt	
<a href="#">PE-BD2218</a>	Tubo PE Natural 15x12 R100 mt	
<a href="#">PE-BD532</a>	Tubo PE Natural 5/32" R.200 mt	
<a href="#">PE-BD3/16</a>	Tubo PE Natural 3/16" R100 mt	
<a href="#">PE-BD1/4</a>	Tubo PE Natural 1/4" R100 mt	
<a href="#">PE-BD5/16</a>	Tubo PE Natural 5/16" R.100 mt	
<a href="#">PE-BD3/8</a>	Tubo PE Natural 3/8" R100 mt	
<a href="#">PE-BD1/2</a>	Tubo PE Natural 1/2" R100 mt	

NSF De -30 a 70°C. Presión de servicio entre 6 y 12 bar  
Flexible, estable, resistencia a la corrosión, Industria química, hospitalaria y alimentaria. Otros colores a consultar.



### MANGUERA AIRE 20 Bar -20°C +65°C

<a href="#">AMG613</a>	Manguera aire 20 bar Azul 6x13 rollo 100 mt	
<a href="#">AMG815</a>	Manguera aire 20 bar Azul 8x15 rollo 100 mt	
<a href="#">AMG1017</a>	Manguera aire 20 bar Azul 10x17 rollo 50 mt	
<a href="#">AMG1219</a>	Manguera aire 20 bar Azul 12x19 rollo 50 mt	
<a href="#">AMG1522</a>	Manguera aire 20 bar Azul 15x22 rollo 50 mt	
<a href="#">AMG1928</a>	Manguera aire 20 bar Azul 19x28 rollo 50 mt	
<a href="#">AMG2533</a>	Manguera aire 20 bar Azul 25x33 rollo 50 mt	

Nota: Marca Rylsol. Servida en rollos de 100 y/o 50 mts



### Tubo SYNFLEX 1300 Aluminio/polietileno ASTM A - 1428 clase C. color NEGRO

<a href="#">DKB06R75</a>	Tubo Dekabon 6mm ext. Rollo 75 mts	
<a href="#">DKB08R75</a>	Tubo Dekabon 8mm ext. Rollo 75 mts	
<a href="#">DKB10R75</a>	Tubo Dekabon 10mm ext. Rollo 75 mts	
<a href="#">DKB12R75</a>	Tubo Dekabon 12mm ext. Rollo 75 mts	

Otras medidas bajo pedido. Denominado DEKABON  
Tubo maleable y resistente a impactos. Para instrumentación, construcción naval y ferroviaria. -40°C +80°C 20bar



### MANGUERA P/TRANSPORTE NEUMÁTICO (Bajo pedido puede ser Antiestática) Rols 10mt

<a href="#">MANT25</a>	Manguera transporte diam.25 Rollo 10 mt	
<a href="#">MANT40</a>	Manguera transporte diam.40 Rollo 10 mt	
<a href="#">MANT75</a>	Manguera transporte diam.75 Rollo 10 mt	
<a href="#">MANT100</a>	Manguera transporte diam.100 Rollo 10 mt	
<a href="#">MANT150</a>	Manguera transporte diam.150 Rollo 10 mt	

Manguera Poliester-Poliuretano con espiral de acero galvanizado -40°C +100°C Bajo pedido rollos de 20 mts



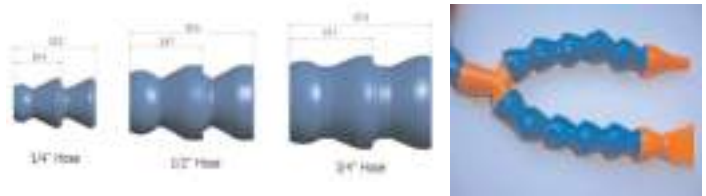

**MÓDULOS OEL - REFRIGERACIÓN PARA TALADRINA, ACEITES, AGUA, AIRE, etc.:** 2,5 bar Buena tolerancia a la corrosión, anti-conductividad, compatibilidad con otros fabricantes.

<b>SISTEMA 1/4</b> Herramienta disponible 1/4 aluminio	
OEL 1/4" Hose	Módulo Cuerpo Azul 1/4"
OEL 1/8" R.N.	Boquilla Circular 1/8" Naranja (p.1/4)
OEL 1/4 1/8RN	Boquilla Circular 1/4" Naranja (p.1/4)
OEL 1" Flare	Boquilla Plana 1" Naranja Mod. 1/4"
OEL PT 1/8"	Módulo Roscado 1/8" M Naranja (p.1/4)
OEL PT 1/4"	Módulo Roscado 1/4" M Naranja
OEL 1/4" Y	Módulo Y 1/4" Naranja
OEL 1/4" D.S.	Módulo Doble 1/4"
OEL 1"N16	Módulo Peine 1" 16 Agujeros p.1/4"
OEL 1,5"N16	Módulo Peine 1,5" 16 Agujeros p.1/4"
OEL 1/4" Valve	Válvula Cierre Mod. 1/4" Azul
OEL 1/4" T.V.	Válvula Cierre S.1/4" a Macho 1/4

<b>SISTEMA 1/2</b> Herramienta disponible 1/2 aluminio	
OEL 1/2" Hose	Módulo Azul 1/2"
OEL 1/4" R.N.	Boquilla Circular 1/4" Naranja (p.1/2)
OEL 3/8" R.N.	Boquilla Circular 3/8" Naranja (p.1/2)
OEL 1-1/4" F.	Boquilla Plana 1"- 1/4" Naranja Mod. 1/2"
OEL 2-1/2" F.	Boquilla Plana 2"- 1/2" Naranja Mod. 1/2"
OEL PT 3/8"	Módulo Roscado 3/8" M Naranja
OEL PT 1/2"	Módulo Roscado 1/2" M Naranja
OEL 1/2" Y	Módulo Y 1/2" Naranja
OEL 1/2"1/4"Y	Módulo Y Reducción 1/2" 1/4" Naranja
OEL 1/2" D.S.	Módulo Doble 1/2"
OEL 1/2" Valve	Válvula Cierre Mod. 1/2" Azul
OEL 2" N20	Módulo Peine 2" 20 Agujeros p.1/2"
OEL 1/2" T.V.	Válvula Cierre S.1/2" a Macho 1/2

<b>SISTEMA 3/4</b> Herramienta disponible 3/4 aluminio	
OEL 3/4" Hose	Módulo Cuerpo Azul 1/4" (
OEL 5/8" R.N.	Boquilla Circular 5/8 (p.3/4) Naranja
OEL 3" F.	Boquilla Plana 3" Naranja Mod. 3/4"
OEL PT 3/4"	Módulo Roscado 3/4" M Naranja

**MONTAJES MÓDULOS 1/4 y 1/2**

OEL 1/4" 300	Conjunto cuerpo azul 1/4" 300mm
OEL 1/4" 400	Conjunto cuerpo azul 1/4" 400mm
OEL 1/4" 500	Conjunto cuerpo azul 1/4" 500mm
OEL 1/4" 600	Conjunto cuerpo azul 1/4" 600mm
OEL 1/2" 300	Conjunto cuerpo azul 1/2" 300mm
OEL 1/2" 400	Conjunto cuerpo azul 1/2" 400mm
OEL 1/2" 500	Conjunto cuerpo azul 1/2" 500mm
OEL 1/2" 600	Conjunto cuerpo azul 1/2" 600mm



**SISTEMA 3/4**

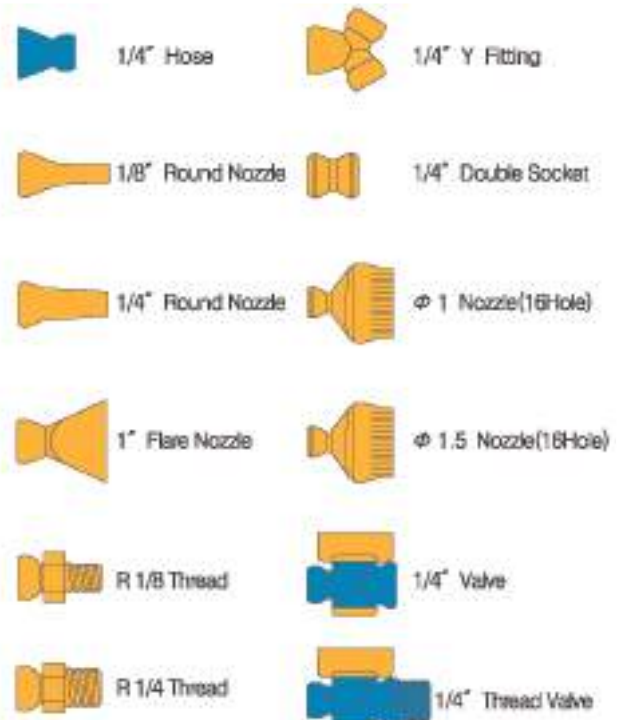
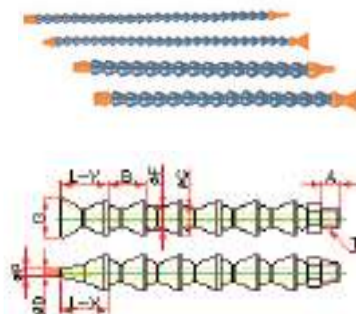

**SISTEMA 1/4**

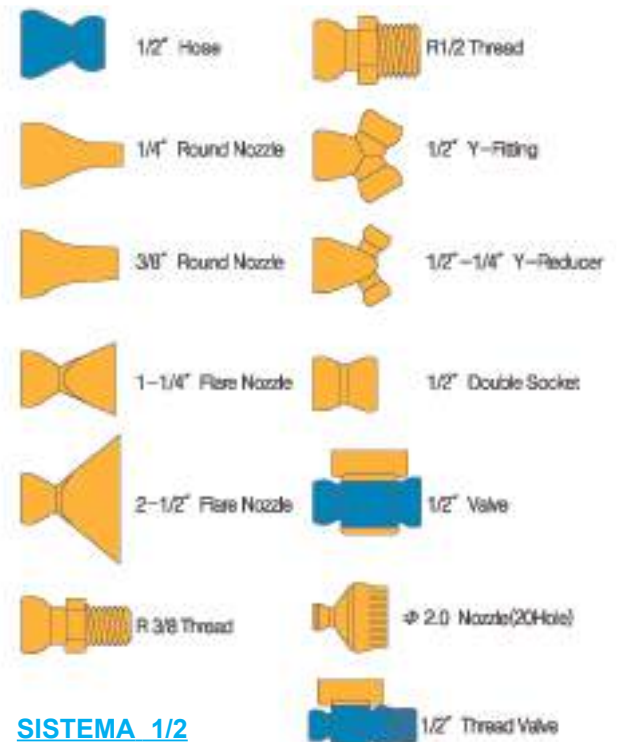

**SISTEMA 1/2**

OEL : Cotas de lo elementos de refrigeración p/aceites, taladrina, agua, etc.

MODELO	T	L/X	L/Y	D	P	G	F	C	B	A	H
OEL 01	R 1/8	28.0	29.5	3.1	6.5	27.0	12.5	16.0	13.7	11.0	13.5
OEL 02	R 1/4	28.0	29.5	3.1	6.5	27.0	12.5	16.0	13.7	11.0	14
OEL 03	R 3/8	39.5	41.2	6.1	10.2	33.1	21.5	24.9	21.5	12.0	19
OEL 04	R 1/2	39.5	41.2	6.1	10.2	33.1	21.5	24.9	21.5	15.0	22
OEL 06	R 3/4	43.9	53.3	16.1	19.6	79.9	27.8	31.1	23.1	16.5	28

## EXPOSITORES DE RACORES, TUBERIA, etc...

Expositores destinados únicamente a la venta de un stock de racordaje o elementos variados... (no se venden sin material nuestro)..., tantas posiciones cómo gavetas haya en cada expositor, o bien, por un importe de tubería y elementos variados según oferta a petición del cliente.  
El importe (NETO) de compra debe ser aproximado a cada una de las variantes de expositor y se comparte el coste con el cliente, siendo el descuento para el material que se destine al pedido del expositor tres puntos inferior al habitual. Portes Pagados para cada envío.

**-EXP1** - Con la compra de \_\_\_\_ € se incluye 1 Expositor 50x60 cm c/plataforma metálica y 23 cajones de policarbonato: 1 ABA + 1 BA5 + 3 BA6

**-EXP2** - Con la compra de \_\_\_\_ € se incluye 1 Expositor 100x60 cm c/plataforma metálica y 45 cajones de policarbonato: 1 SBA10 + 3 BA5 + 5 BA6

**-EXP3** - Con la compra de \_\_\_\_ € se incluye 1 Expositor 200x60 cm c/plataforma metálica y 73 cajones de policarbonato: 1 SBA20 + 5 BA5 + 8 BA6

**-EXP4** - Con la compra de \_\_\_\_ € se incluye 1 Carro de 140x66 cm c/plataforma metálica y 90 cajones de policarbonato: 1 CARRO + 6 BA5 + 10 BA6



### BASBOX, es ideal para el montaje en furgonetas de servicio técnico

Sus soportes permiten fijarlos a las paredes de las furgonetas y las varillas de seguridad impiden que los cajones se abran incluso en las curvas más pronunciadas.

### BA-5

Exteriores: (HxAxF)  
164 x 600 x 133 mm  
Interior: (HxAxF)  
147 x 107 x 107 mm  
Composición:  
Funda y 5 cajones



### BA-6

Exteriores: (HxAxF)  
112 x 600 x 91 mm  
Interior: (HxAxF)  
96 x 87 x 70 mm  
Composición:  
Funda y 6 cajones



TODOS LOS EXPOSITORES LOS HEMOS ESTANDARIZADO SÓLO CON 2 MODULOS DE 5 Y 6 CAJONES. BA-5 / BA-6

## MALETIN EXPOSITOR- STOCK- PRESENTACIÓN AIRTX

Objetivo del maletín: En la promoción de los artículos AIRTX es esencial su demostración y exposición tanto en plaza como en visitas a domicilio, puesto que el público todavía desconoce el valor de éstos productos y se muestran escépticos de su efectividad y funcionalidad. Para facilitar esta demostración, los elementos vienen con los racores necesarios para su alimentación. Siempre hay que asegurarse que llegue un caudal adecuado a cada uno de ellos y una presión mínima de 5,5 bar. Si se hacen las pruebas con un prefiltro de 5 micras, mejor.

### COMPOSICIÓN:

- " Ref: 15015 Amplif. de aire ajustable 51mm 3/8H 20:1
- " Ref: 70015 Control Cooler - Vortex Inox 277 Kcal/H
- " Ref: 86006 Barrera aire Hurricane 152 mm 850 l/min
- " Ref: 48005 Boquilla Seguridad Al.Hurricane 1/4H 25: 1
- " Ref: 38050 Boquilla Plana Al. 1/4H 25:1
- " Tubo Poliuretano + Racores + maletín + montaje

### OPCIONALES:

- ME50005 Tester electrónico estática AIRTX
- ME50025 Lápiz indicador Polaridad >500 -+Volt AIRTX
- ME8215 Termómetro Infrarrojo de -32°C a 300°C
- ME8220 Medidor digital - Sonómetro de 30 a 130dbA
- ME8225 Anemómetro digital
- ME8035120 Termómetro reloj latón insertar R.1/2"M.0-120°C



# RACORES PVDF - Polifloruro de Vinilideno y Racores FEP

## RACORES PVDF + INOX TIPO INSTANTÁNEOS

Plazos de 10 a 24 días. Precios, Diámetros, Roscas y disponibilidades a consultar.



### RACORES EN PVDF

Especificaciones:

Material: fluoruro de polivinilideno. (Tipo SO) + acero Inox A316 (Tipo Instantáneo)

Especialmente resistente a los fluidos químicos corrosivos, alifáticos, aromáticos, ácidos carboxílicos, alcoholes, cloruros y mercaptanos.

El PVDF no es resistente a las aminas alcalinas, metales alcalinos y álcalis.

Para cada aplicación es recomendable ver tablas de compatibilidades químicas para una correcta selección del material.

Presión de trabajo (PN): 10 bar a +23 °C. Temperatura de trabajo: -40°C a +100°C.

El PVDF cumple con la CFR 21, § 177.2510 de la FDA y puede ser utilizado en contacto con alimentos. Temperatura de servicio: 32-140°F 0-60°C

## RACORES PVDF y FEP TIPO RÁPIDOS. FABRICADOS ENTERA Y ÚNICAMENTE EN ESTOS MATERIALES

Plazos de 3 a 12 días. Precios, Diámetros, Roscas y disponibilidades a consultar.

					
Anillo Ref. SO 20001	Tapón Ref. SO 20002	Tuerca hexagonal Ref. SO 20006 METR	Tuerca Ref. SO 20020	Adaptador hembra Ref. SO 20030	Espiga manguera Ref. SO 20503
					
Racor unión recto Ref. SO 21021	Racor macho recto cónico Ref. SO 21121	Racor macho recto NPT Ref. SO 21121 NPT	Racor macho recto cilíndrico Ref. SO 21124	Racor macho recto cilíndrico junta FKM Ref. SO 21124 OR	Racor recto hembra Ref. SO 21221
					
Enlace Ref. SO 21300	Enlace reductor Ref. SO 21300 RED	Adaptador macho ajustable Ref. SO 21600	Racor unión reductor Ref. SO 21821	Racor codo Ref. SO 22021	Racor codo hembra Ref. SO 22221
					
Racor codo macho cónico Ref. SO 22421	SO 22421 NPT Ref. SO 22421 NPT	Racor codo ajustable Ref. SO 22621	Racor pasatabiques codo Ref. SO 22721	Racor Te Ref. SO 23021	Racor Te reducida Ref. SO 23021 RED
					
Racor Te hembra Ref. SO 23221	Racor Te ajustable Ref. SO 23521	Racor Te macho central cónico			



# TABLA DE COMPATIBILIDADES QUIMICAS

Elementos que conforman racores y tubería

Círculo doble = Excelente    Círculo simple = Válido    Triángulo = A confirmar    X = Incompatible    - Sin datos

Judgement Standard    ○ : Excellent    ◯ : Good    △ : Require confirmation    × : Incompatible    - : No data

약품명 (용량농도%, 온도℃)	Fitting						Tube 종류				Seal 재질		
	Latón	SUS304	SUS316	POM	PBT	PP	Urethane	Nylon	Polyolefin	불소	NBR	EPCM	FKM
Cautic soda 가성소다(10% 20℃)	△	△	○	○	△	○	×	○	○	○	○	○	○
Cautic soda 가성소다(30% 20℃)	-	-	-	○	×	○	×	○	○	○	-	-	-
Cautic soda 가성소다(30% 70℃)	-	-	-	○	×	△	×	×	△	○	-	-	-
Gasoline 가솔린	○	○	○	○	○	△	○	○	△	○	○	×	○
Air 공기	○	○	○	○	○	○	○	○	○	○	○	○	○
Sodium perborate 과붕산나트륨	×	-	○	○	○	○	-	○	○	○	○	○	○
Sodium peroxide 과산화나트륨	×	-	○	-	-	○	-	×	○	○	○	○	○
Hydrogen peroxide 과산화수소(5% 20℃)	×	○	○	○	○	○	○	○	○	○	-	-	-
Hydrogen peroxide 과산화수소(5% 20℃)	×	○	○	△	○	○	△	△	○	○	-	-	-
Hydrogen peroxide 과산화수소(30% 20℃)	×	○	○	×	○	○	×	×	○	○	-	-	-
Perchloric acid 과염소산	×	×	×	×	○	○	×	×	○	○	-	○	○
Grease 그리스	○	○	○	○	○	△	○	○	△	○	○	×	○
Sodium silicate 규산나트륨	△	-	○	○	○	○	○	○	○	○	○	○	○
Glycerin 글리세린	○	○	○	○	○	○	○	○	○	○	○	○	○
Naphtha 나프타	△	○	○	○	○	△	△	○	△	○	△	×	○
Naphthalene 나프탈렌	△	-	△	○	○	○	△	○	△	○	×	×	○
Nitropropane 니트로프로판	-	-	-	○	-	○	-	-	○	○	-	-	-
Kerosene 등유	○	○	○	○	○	△	○	○	△	○	○	×	○
Dichloro benzene 디클로로벤젠	△	-	-	△	△	△	×	△	×	○	-	-	-
Linoleic acid 리놀레인산	-	-	-	○	-	△	-	△	△	○	○	×	○
Maleic acid 말레인산	-	△	△	-	-	○	△	○	○	○	-	△	○
Cottonseed oil 면실유	△	○	○	○	-	○	○	○	○	○	○	○	○
Methane 메탄	○	-	△	○	○	○	○	○	○	○	○	×	○
Methyl alcohol(Methanol) 메틸알코올(에탄올)	○	△	○	○	○	○	△	○	○	○	○	○	△
Methyl ethyl ketone(MEK) 메틸에틸케톤	○	△	○	○	○	○	×	○	○	○	×	○	×
Methyl isobutyl ketone(MIBK) 메틸이소부틸케톤	△	-	△	○	○	○	×	○	○	○	×	△	×
Monochloroamine 모노클로로아민	-	-	△	○	-	○	-	○	△	○	×	○	×
Monochlorobenzene 모노클로로벤젠	-	-	-	○	-	×	×	×	×	○	×	×	○
Chloroacetic acid 모노클로로초산	-	-	-	△	△	×	×	×	×	○	-	-	-
Hydrofluoric acid Anhydride 무수불화수소산	×	-	×	×	-	×	×	×	×	○	-	○	-
Acetic Anhydride 무수초산	×	○	○	×	-	△	×	×	△	○	△	○	×
Water 물 (24℃)	○	○	○	○	○	○	○	○	○	○	○	○	○
Water 물 (100℃)	×	○	○	△	×	△	△	△	△	○	-	-	-
Sea Water 바닷물	△	○	○	○	○	○	○	○	○	○	-	-	-
Bunker oil 벙커유	△	-	○	-	-	○	-	○	○	-	○	-	○
Benzene(Benzol) 벤젠(벤졸)	×	△	△	○	○	△	×	○	×	○	×	×	○
Butane 부탄	○	○	○	○	○	○	-	○	△	○	○	×	○
Fluorine 불소	×	×	△	×	-	×	×	-	×	×	-	△	○
Borax 붕사	×	-	○	-	-	○	○	○	○	○	○	○	○
Boric acid 붕산	○	○	○	○	○	○	○	○	○	○	○	○	○
Amyl borate 붕산아밀	-	-	-	○	-	△	-	-	△	○	○	×	○
Bromine 브롬	×	-	×	×	×	△	×	×	×	○	-	-	○
Arsenic acid 비산	△	○	○	-	-	○	-	△	○	○	-	-	-
Carbon tetrachloride 사염화탄소	△	△	△	○	○	△	×	△	×	○	△	×	○
Oxygen 산소	○	○	○	○	○	○	○	○	○	○	○	○	○
Petroleum 석유	-	-	-	○	○	×	○	○	×	○	○	×	○

## TABLA DE COMPATIBILIDADES QUIMICAS Elementos que conforman racores y tubería.

Compare sus necesidades de uso de fluidos con las tablas de éstas cuatro últimas páginas. Si no aparece el fluido con el que trabaja, puede consultar a nuestro departamento técnico. Es importante tener en cuenta factores como presión, temperatura, concentración de agua o incluso factores ambientales como la proximidad con ambientes salinos, húmedos, vapores químicos, etc.. Ya que, aunque la pieza aguante interiormente el fluido, puede que exteriormente tenga otro tipo de corrosión, por ejemplo, con las pinzas o sujeciones.

Para conocer si un componente, racor o tubo de este catálogo es compatible con algún fluido, debe tener en cuenta todos los materiales que lo componen. En cada gama de productos, nombramos estos materiales para su posterior chequeo.

Por ejemplo: los racores FLUIDFIT están compuestos de SUS304 + POM + EPDM ...: Deberá comprobar si el fluido de su aplicación es compatible al menos "Excelente/Excellent" y/o "Bueno/good" con esos 3 elementos. Si falla alguno de ellos habrá que hacer un estudio más a fondo con otras tablas y pruebas de laboratorio y, puede que finalmente, haya que proponer otro componente fabricado con materiales más resistentes como el PTFE, FEP, PVDF, PP, etc. (CdA los puede suministrar todos)

약품명 (중립농도%, 온도 °C)	Fitting						Tube 종류				Seal 재질		
	황동	SUS304	SUS316	POM	PBT	PP	Urethane	Nylon	Polyolefin	불소	NBR	EPDM	FKM
Salt Water 소금물	×	△	△	○	○	○	-	○	○	○	-	-	-
Soda water 소다수	-	-	-	○	○	○	○	○	○	○	-	-	-
소다회-탄산나트륨 Soda ash-Sodium carbonate	○	△	△	○	○	○	○	○	○	○	○	○	○
Pine oil 송진	△	○	○	-	○	○	-	×	○	○	○	×	○
Oxalic acid 수산	△	△	△	×	○	○	△	○	○	○	○	○	○
Ethyl oxalate 수산화에틸	-	-	-	○	○	×	×	○	×	○	×	○	○
Magnesium hydroxide 수산화마그네슘	△	-	△	○	×	○	△	○	○	○	○	○	○
Barium hydroxide 수산화바륨	×	-	○	○	△	○	-	○	○	○	○	○	○
Ammonium hydroxide 수산화암모늄	×	△	○	○	×	○	△	○	○	○	×	○	○
Potassium hydroxide 수산화칼륨	△	△	△	○	×	○	△	△	○	○	○	○	○
Calcium hydroxide 수산화칼슘	△	△	△	○	×	○	△	○	○	○	○	○	○
Hydrogen 수소	△	○	○	○	○	○	○	○	○	○	○	○	○
Mercury 수은	×	-	△	-	-	○	-	○	○	○	○	○	○
Steam 수증기(150°C 이하)	○	-	○	△	△	×	×	×	×	○	×	○	×
Steam 수증기(150°C 이상)	-	-	-	×	×	△	×	×	×	○	×	○	×
Vegetable oil 식용성유	-	-	-	○	○	○	-	○	○	○	○	○	○
Salt water 식염수	△	△	△	○	○	○	○	○	○	○	-	-	-
Silicone greases 실리콘그리스	-	-	-	○	○	△	-	○	△	○	○	○	○
Silicone oil 실리콘유	-	-	-	○	○	△	-	○	△	○	○	○	○
Gluin 아교	△	-	△	-	-	○	-	○	○	○	-	-	-
Aniline 아닐린	×	△	△	○	○	△	×	×	×	○	×	○	△
Amylnaphtalene 아밀 나프탈렌	-	-	-	○	○	△	-	-	△	○	×	×	○
Amyl alcohol 아밀 알코올	○	△	△	○	○	○	○	○	○	○	○	○	○
Acetone 아세톤	○	△	○	○	○	△	×	○	△	○	×	○	×
Acetamide 아세트아미드	-	-	-	○	○	△	-	-	△	○	○	○	○
Acetaldehyde 아세트알데히드	○	○	○	○	○	○	○	○	△	○	×	○	×
Acetylene 아세틸렌	×	○	○	○	○	○	○	○	○	○	○	○	○
Sulfurous acid 아황산	×	△	△	×	○	○	×	×	○	○	○	○	○
Sulfurous acid gas 아황산가스	-	-	○	△	○	○	×	×	△	○	○	○	○
Sodium sulfite 아황산나트륨	○	○	○	○	○	○	-	△	○	○	-	-	-
Ammonia 암모니아(무수)	△	○	○	○	△	○	-	○	○	○	○	○	×
Ammonia gas 암모니아가스(액)	×	○	○	○	△	△	×	△	△	○	○	○	×
Ammonia gas 암모니아가스(증기)	×	○	○	○	×	×	×	×	×	○	○	○	×
Liquid Ammonia 액체 암모니아	○	○	○	○	△	○	-	○	○	○	-	-	-
Chlorine Liquid 액체염소	-	-	-	×	○	×	×	×	×	○	-	-	-
Liquefied petroleum gas(LPG) 액화석유가스	○	○	○	○	○	△	-	○	△	○	○	×	○
Ethanolamine 에타놀아민	-	-	-	○	△	△	-	△	△	○	○	○	×
Ethylene glycol 에틸렌글리콜	△	△	△	○	○	○	○	○	○	○	○	○	○
Ethyl cellulose 에틸셀룰로오스	-	-	△	○	○	○	-	-	○	○	-	○	×
Ethyl alcohol(Ethanol) 에틸알코올(에타놀)	○	○	○	○	○	○	△	○	○	○	○	○	○
Lye solution 양잿물	-	-	-	○	○	○	-	○	○	○	○	○	○
Hydrochloric acid 염산(10%, 20°C)	×	×	×	×	○	○	△	○	○	○	-	-	-
Hydrochloric acid 염산(20%, 20°C)	×	×	×	×	△	○	×	×	○	○	-	-	-
Hydrochloric acid 염산(20%, 60°C)	×	×	×	×	×	×	×	×	×	○	×	△	○
Hydrochloric acid 염산(36%, 20°C)	×	×	×	×	△	○	×	×	○	○	○	○	○
Magnesium chloride 염화마그네슘	△	△	○	○	○	○	○	○	○	○	○	○	○

# TABLA DE COMPATIBILIDADES QUIMICAS

Elementos que conforman racores y tubería.

Círculo doble = Excelente    Círculo simple = Válido    Triángulo = A confirmar    X = Incompatible    - Sin datos

Judgement Standard    ○ : Excellent    ◯ : Good    △ : Require confirmation    × : Incompatible    - : No data

약품명 (중성농도%, 온도℃)	Fitting						Tube 종류				Seal 재질		
	황동	SUS304	SUS316	POM	PBT	PP	Urethane	Nylon	Polyolefin	플라스틱	NBR	EPDM	FKM
Methyl chloride 염화메틸	○	○	○	○	-	×	×	△	×	○	×	△	○
Barium chloride 염화바륨	×	-	○	-	○	○	○	○	○	○	○	○	○
Zinc chloride 염화아연	×	△	○	×	○	○	○	○	○	○	○	○	○
Acetyl chloride 염화아세트	-	-	△	×	-	×	×	×	×	-	-	-	○
Aluminium chloride 염화알루미늄	×	×	×	-	○	○	-	△	○	○	○	○	○
Ammonium chloride 염화암모늄	×	△	△	○	○	○	○	○	○	○	○	○	○
Ethyl chloride 염화에틸	○	○	○	○	-	×	×	○	×	-	○	○	○
Sulfur chloride 염화유황	×	-	△	-	-	△	-	-	△	○	△	×	○
Potassium chloride 염화칼륨	△	△	○	○	○	○	○	○	○	○	○	○	○
Calcium chloride 염화칼슘	○	△	△	○	○	○	○	○	○	○	○	○	○
Ozone 오존	○	○	○	△	○	△	△	○	△	○	○	○	○
Diac acid 디아세트산	△	△	△	△	○	○	△	○	△	○	△	○	○
Olive oil 올리브유	△	○	○	○	○	○	○	○	○	○	○	○	○
Uric acid 요산	-	-	-	○	○	-	×	○	-	○	-	-	-
Aqueous acid 염수	-	-	-	×	-	△	×	×	×	○	-	△	○
Lactic acid 유산	×	△	△	○	○	○	-	○	○	○	○	○	○
Sulfur 유황	×	○	○	○	-	○	△	○	○	○	×	○	○
Lubricating oil(Petroleum base) 윤활유(광물유계)	○	○	○	○	○	×	○	○	×	○	○	×	○
Lubricating oil(Ester base) 윤활유(에스테르계)	○	○	○	○	○	×	×	○	×	○	-	-	-
Isodane 이소옥탄	○	○	○	○	○	×	△	○	×	○	○	×	○
Isopropyl alcohol 이소프로필알코올	○	○	○	○	○	○	-	△	○	○	○	○	○
Isopropyl ether 이소프로필에테르	○	○	○	○	○	○	-	△	△	○	○	×	×
Carbon disulfide 이황화탄소	○	○	○	○	-	×	×	○	×	○	△	×	○
Phenyl disulfide 이황화페닐	-	-	-	-	-	-	△	○	-	○	-	-	-
Carbon monoxide 일산화탄소	○	○	○	○	○	○	○	○	○	○	○	○	○
Gelatin 젤라틴	○	○	○	○	○	○	○	○	○	○	○	○	○
Heavy water 중수	-	-	-	○	○	○	○	○	○	○	-	-	-
Soap solutions 지방산염액(비눗물)	○	○	○	○	○	○	○	○	△	○	○	○	○
Sodium nitrate 질산나트륨	○	○	○	○	○	○	○	○	○	○	○	○	-
Aluminium nitric 질산알루미늄	-	-	△	○	○	○	△	○	○	○	○	○	-
Ammonium nitric 질산암모늄	×	○	○	○	○	○	○	○	○	○	○	○	-
Potassium nitric 질산칼륨	△	△	△	○	○	○	○	○	○	○	○	○	○
Calcium nitric 질산칼슘	-	-	-	○	○	○	-	○	○	○	○	○	○
Nitrogen 질소	○	○	○	○	○	○	○	○	○	○	○	○	○
Natural gas 천연가스	○	○	○	○	○	○	-	○	○	○	○	×	○
Acetic acid 초산(10%, 20℃)	×	○	○	△	○	○	×	△	○	○	○	○	○
Acetic acid 초산(50%, 20℃)	×	○	○	×	○	○	×	×	○	○	-	-	-
Acetic acid 초산(50%, 70℃)	×	○	○	×	△	×	×	×	×	○	-	-	-
Acetic acid 초산(100%, 20℃)	×	△	△	×	△	×	×	×	×	○	-	-	-
Lead acetate 초산납	-	△	-	-	○	○	-	○	○	○	○	○	-
Nickel acetate 초산니켈	-	-	△	-	○	○	-	○	○	○	○	○	×
Zinc acetate 초산아연	-	-	-	○	○	○	-	○	○	○	○	○	×
Aluminium acetate 초산알루미늄	-	-	-	○	○	○	-	○	○	○	○	○	-
Calcium acetate 초산칼슘	△	-	△	○	○	○	○	○	○	○	○	○	×
Cresol 크레졸	○	△	○	△	○	○	×	×	△	○	△	×	○
Chlorosulfonic acid 염로로술폰산	△	×	×	×	○	×	-	×	×	○	×	×	△